

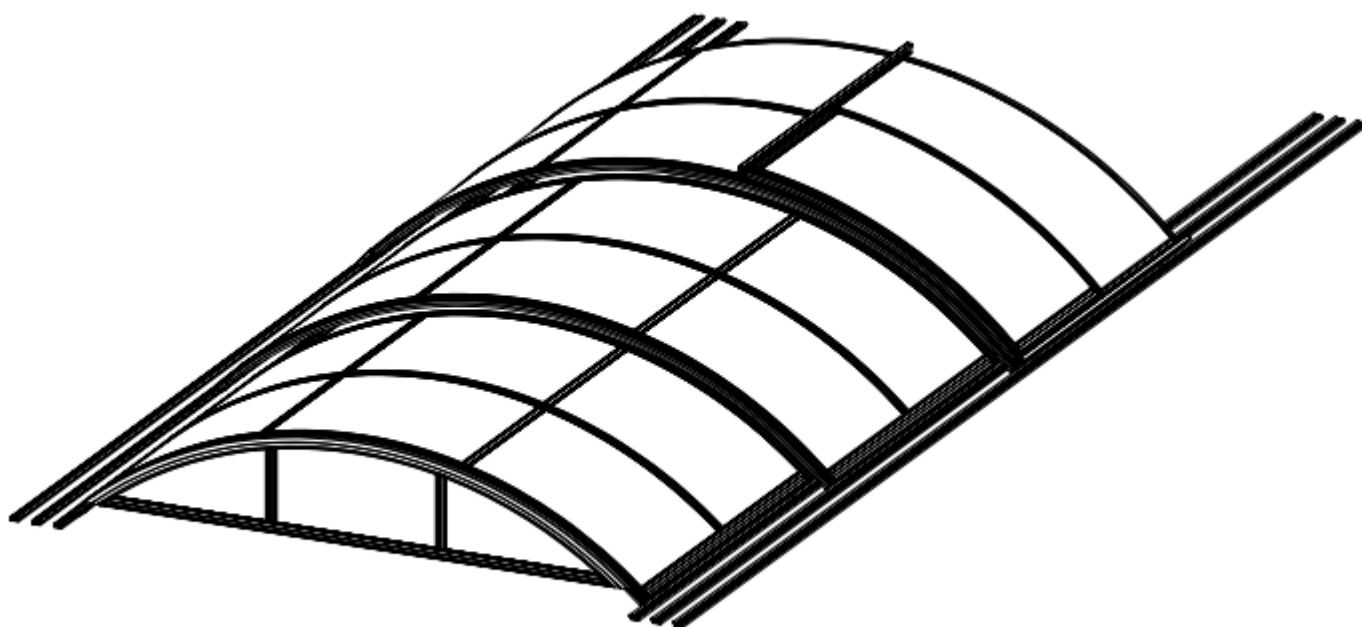

METALCRAFT

Monteringsanvisning



MODELL: 142-2-5 / 142-2-8

STORLEK (L x B x H): 850 x 390 x 88 cm

LÄS IGENOM NOGGRANT FÖRE MONTERING

Monterings- och underhållsanvisningar

1. För din säkerhet, rekommenderar vi att pooltaket monteras av minst tre personer.
2. Några delar har vassa metallkanter. Var försiktig när du hanterar metall- delar. Bär handskar, skor och skyddsglasögon under monteringen.
3. KLÄTTRA INTE och STÅ INTE på pooltaket. Luta inga tunga föremål mot pooltaket.
4. Håll pooltaket fritt från snö, smuts och löv. Om du låter snö ansamlas på pooltaket kan skador uppstå.
5. När pooltaket behöver rengöras, använd en mild blandning av diskmedel och vatten. Skölj med kallt, rent vatten. Använd inte aceton, rengöringsmedel innehållande slipmedel eller andra starka rengöringsmedel vid rengöring av pooltakets paneler.

Verktyg som ingår:

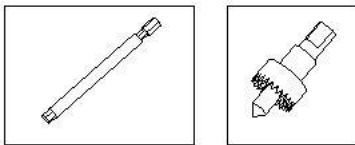



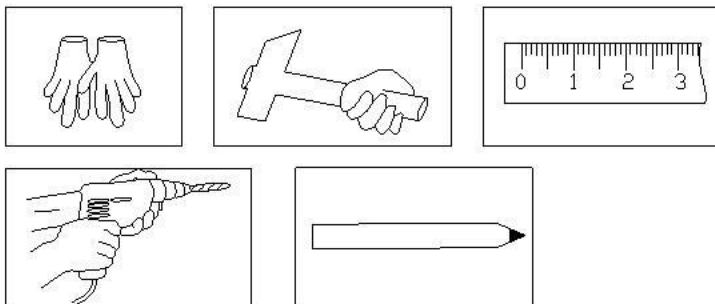

















Verktyg som behövs vid monteringen (ingår inte)



















Monteras av minst tre personer



142-2-5 / 142-2-8 (aluminiumlåda)

DEL	NR.	ST.
	L01A	6
	01-L02A	1
	01-L02B	1
	02-L02A	2
	02-L02B	1
	03-L02A	1
	03-L02B	1
	01-L02G	2
	01-L02H	2
	L04A	12
	L05A	2
	L06A	12
	L08A	1
	L08B	1
	L09A	2
	L11	24
	L12	6
	L13	4
	K1-1	1
	K3-1	1



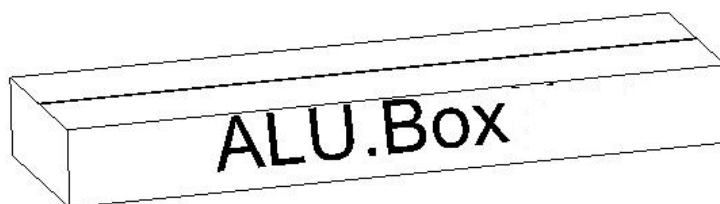





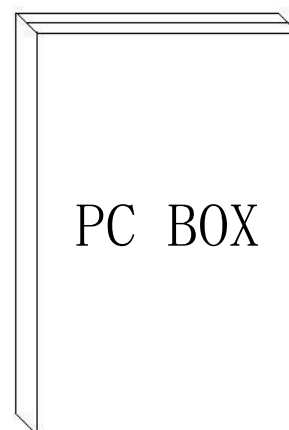

DEL	NR.	ST.
	W01	4
	W02	1
	CX	4
	J01	46
	J02	60
	J03	9 M
	J04	4
	HL	18
	HL2	8
	S01 M6X35	18
	S02 M6X80	60
	M01	26
	M02	18
	Z01 M6X60	44
	Z02 M4.2X16	146
	Z03 M4.2X25	8
	Z04 Ø6X16	8















142-2-5 / 142-2-8 (papplåda)

DEL	NR.	ST.
<input type="checkbox"/>	Y1	4
<input type="checkbox"/>	Y2	6
<input type="checkbox"/>	Y3	6
<input type="checkbox"/>	Y9	1
<input type="checkbox"/>	Y10	1



DEL	NR.	ST.
	L01A	2
	01-L02A	1
	01-L02B	1
	01-L02G	2
	01-L02H	2
	L04A	4
	L05A	2
	L08A	1
	L09A	2
	L11	8
	K1-1	1

DEL	NR.	ST.
	W01	4
	W02	1
	CX	1
	J01	26
	HL	6
	HL2	8
	S01 M6X35	6
	M01	14
	M02	6
	Z01 M6X60	20
	Z02 M4.2X16	53
	Z03 M4.2X25	2
	Z04 Ø6X16	8







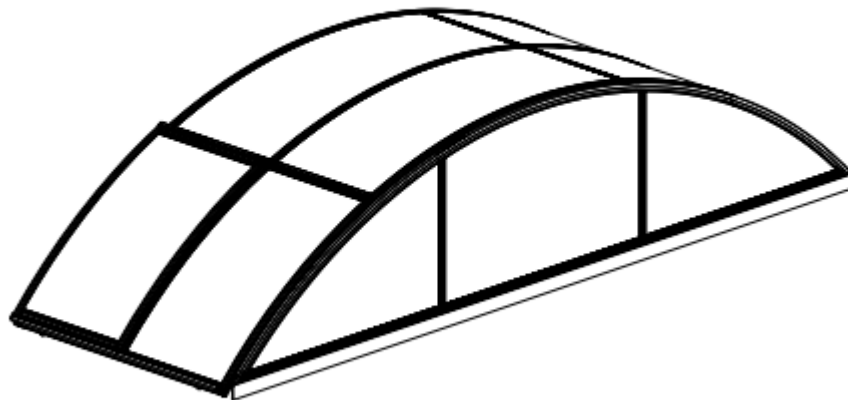

DEL	NR.	ST.
	Y1	4
	Y9	1
	Y10	1

DEL	NR.	ST.
	J03	4,29 M

Montering av K1

K1



PART	NO	QTY
	L01A	2
	K1-1	1
	L08A	1
	HL	6
	M02	6
	S01 M6X35	6
	M01	6
	Z01 Ø6X60	4
	Z02 M4.2X16	5

Montera hjulen på L01A (3 st.)
med S01 & M01.

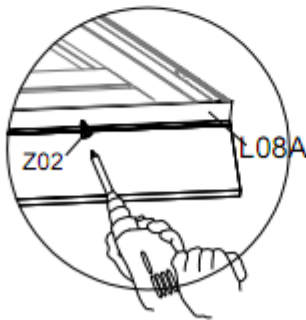
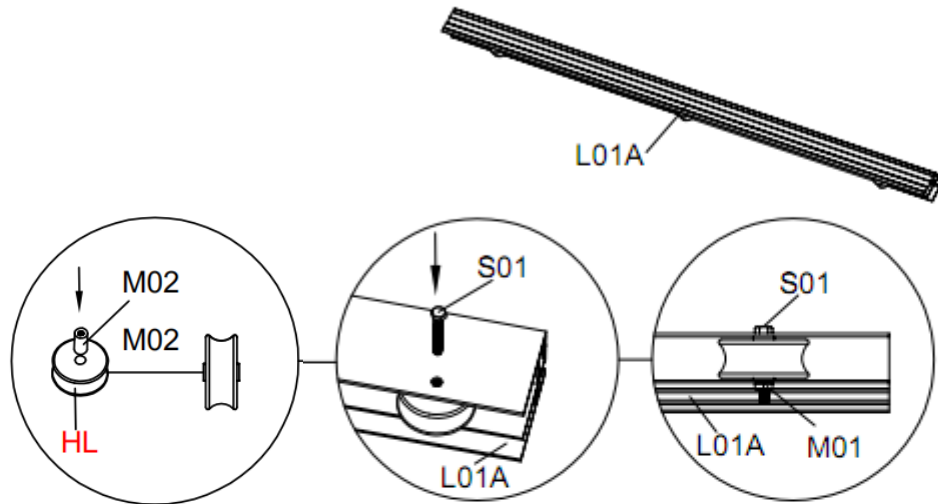



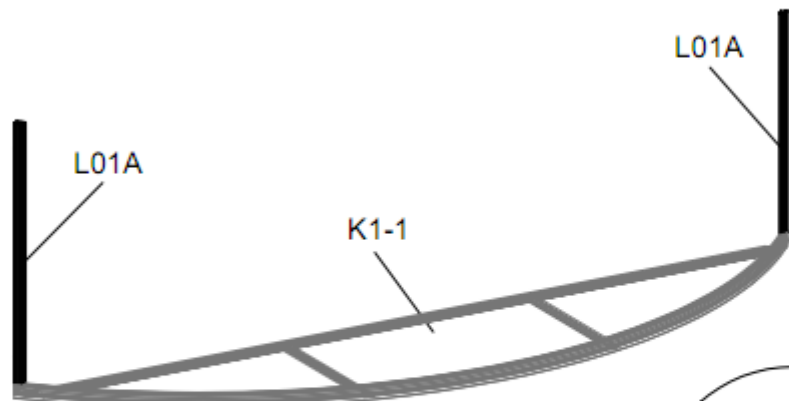

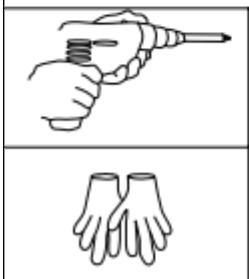
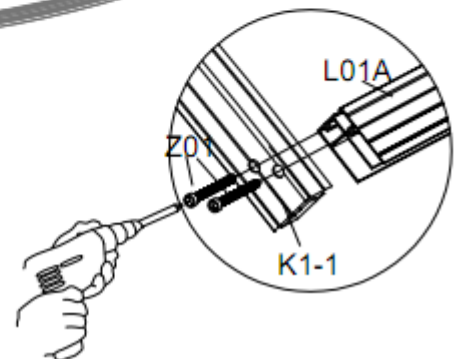

Montera L08A på K1-1 med Z02.



Montera L01A x 2 st. på K1-1 med Z01,
se bilden ovan.



PART	NO	QTY
	L04A	2
	01-L02B	1
	L11	4
	Y1	2
	Z02	16
	M4.2X16	
	Z01	4
	Ø6X60	

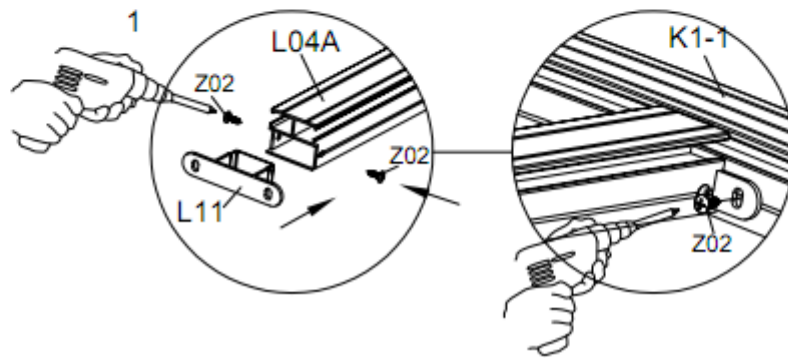
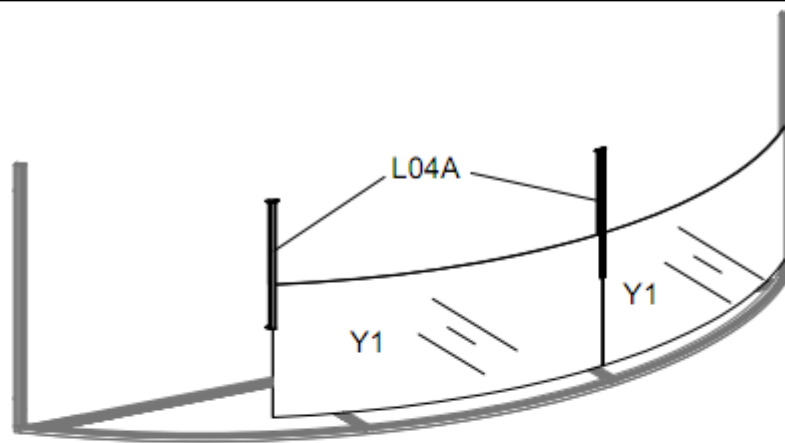

1. För in L11 i L04A, se bilden, och fixera den med Z02;
2. Montera L04A på K1-1, se bilden, med Z02.

Viktigt! Y1 måste placeras i kanalen på L04A & L01 A samtidigt.
Se till att alla paneler sitter rätt innan du drar åt Z02 ordentligt.

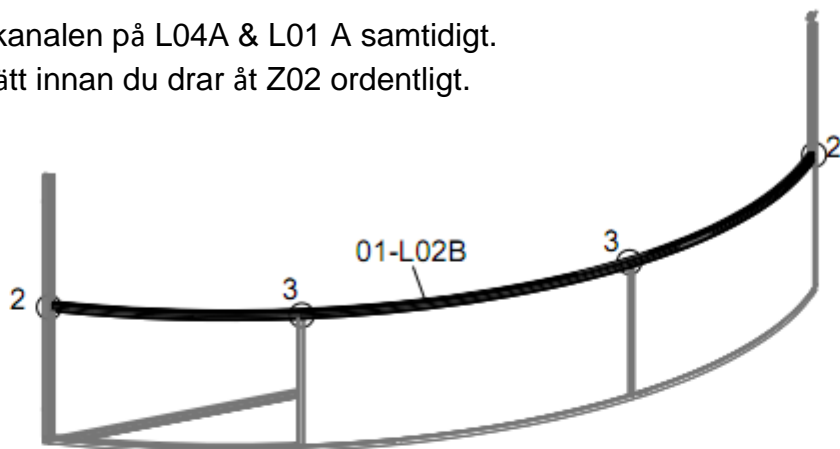

Montera ihop 01-L02B med L01A och L04A, använd Z01 & Z02.

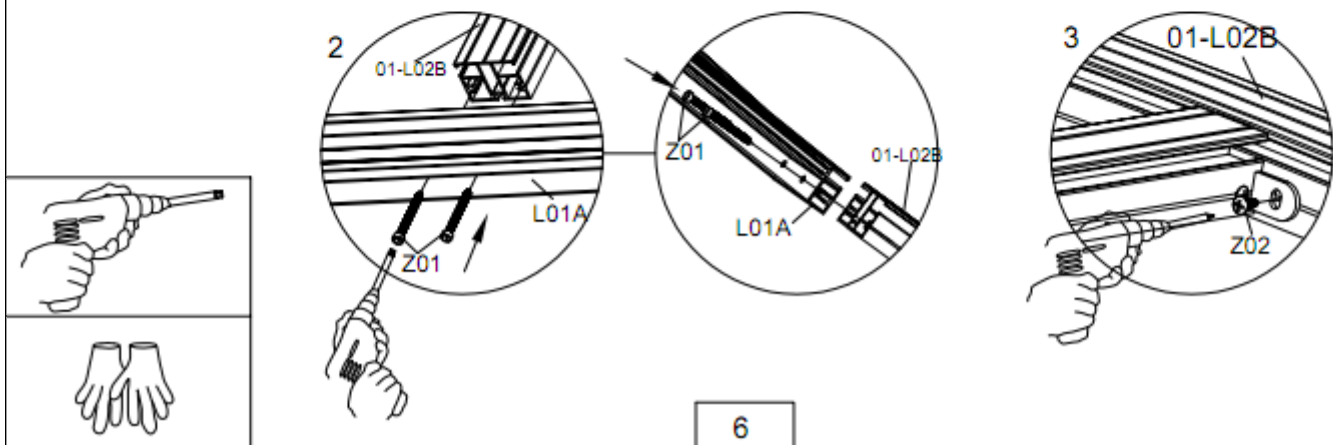

PART	NO	QTY
	01-L02A	1
	L04A	2
	L11	4
	Y1	2
	Y9	1
	Z02 M4.2X16	16
	Z01 Ø6X60	4

Viktigt! Y1 & Y9 måste placeras i kanalen på L04A/L01A samtidigt.
Se till att alla paneler sitter rätt innan du drar åt Z02 ordentligt.

PART	NO	QTY
	J03	4.29M

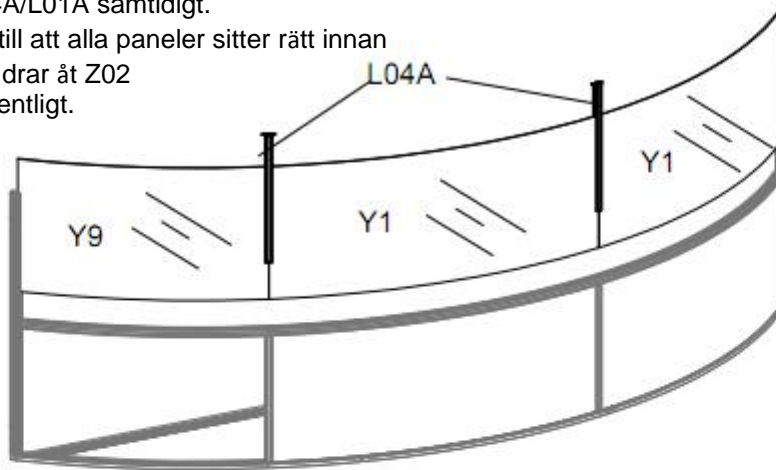

Montera L04A på 01-L02B, se bilden, med Z02.

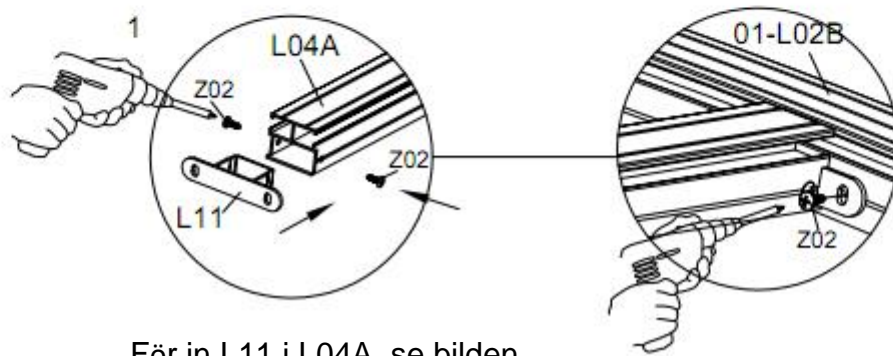

För in L11 i L04A, se bilden, och fixera den på L04A med Z02;

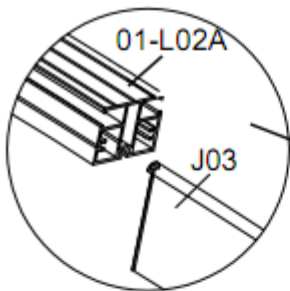



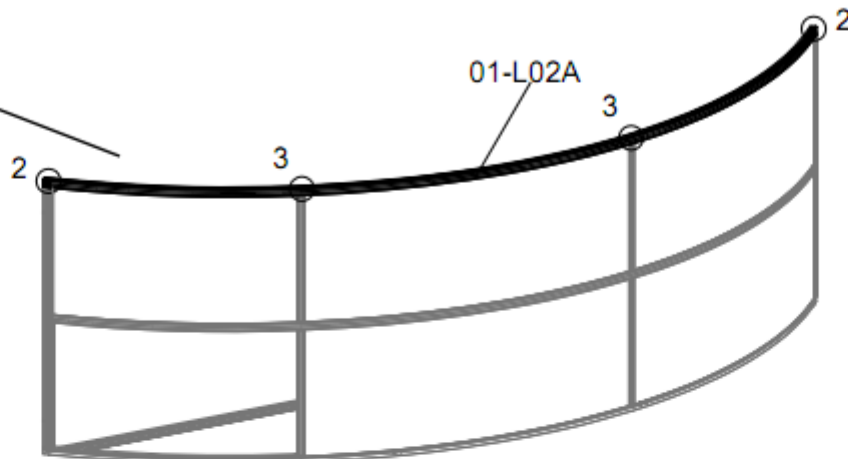

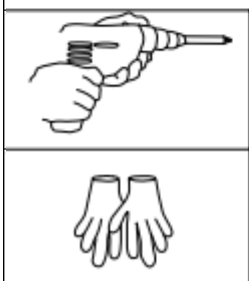
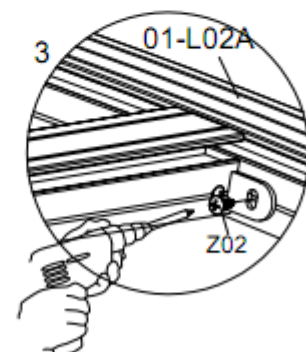
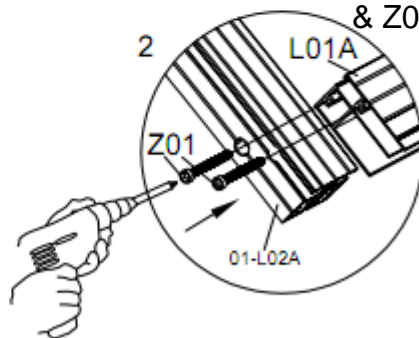

För in gummit J03 i kanalen på 01-L02A.





Montera ihop 01-L02A med L01A och L04A, använd Z01 & Z02.





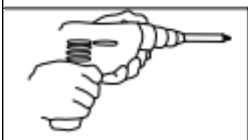
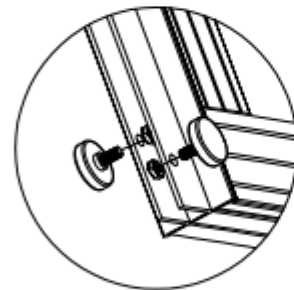
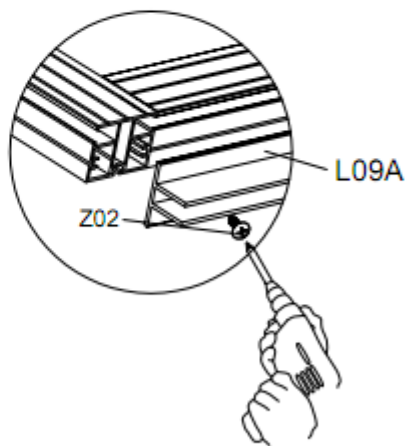
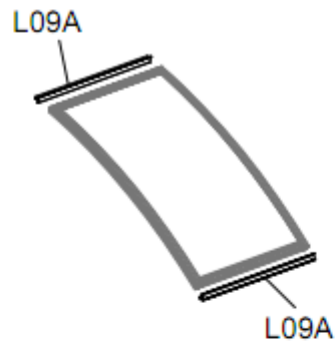
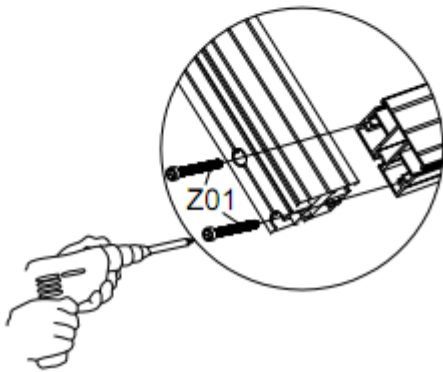
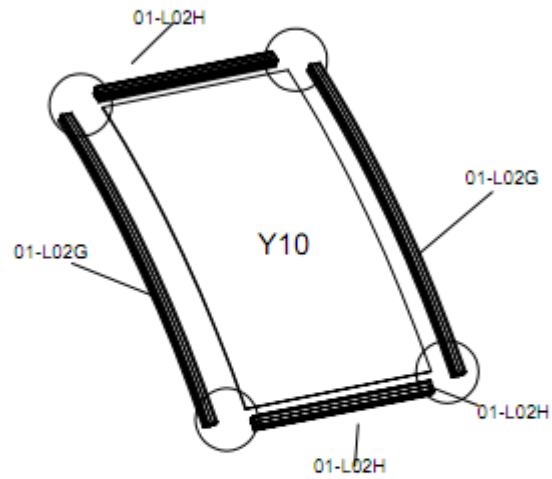



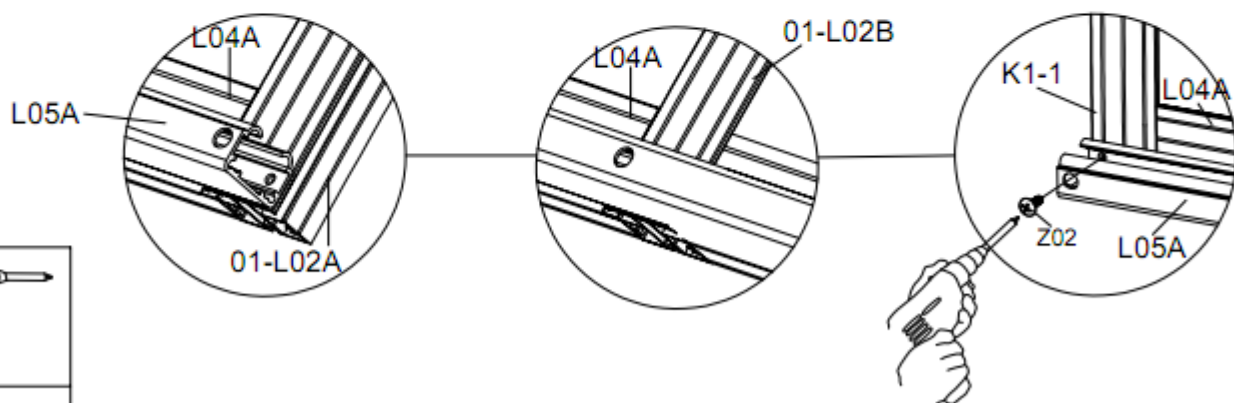
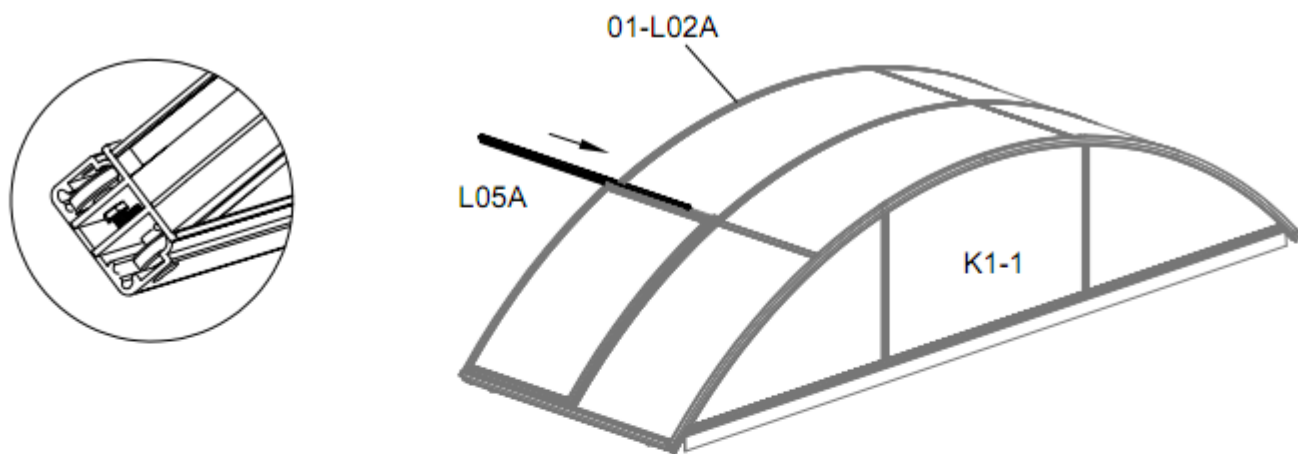
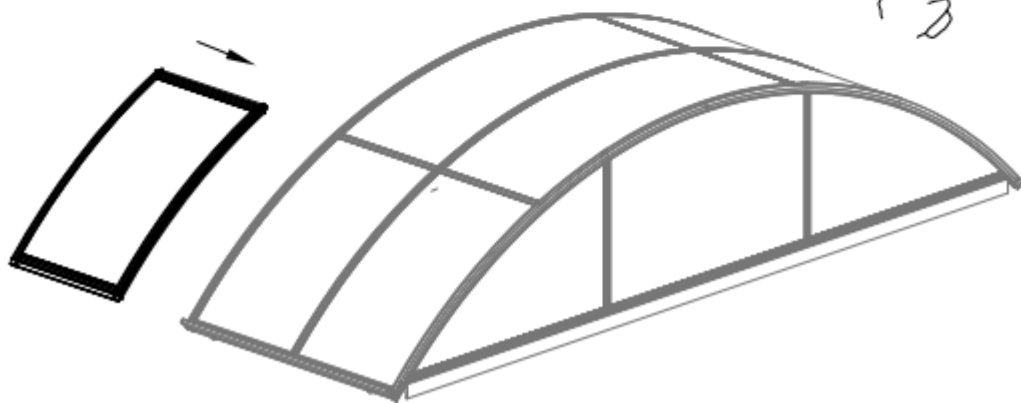
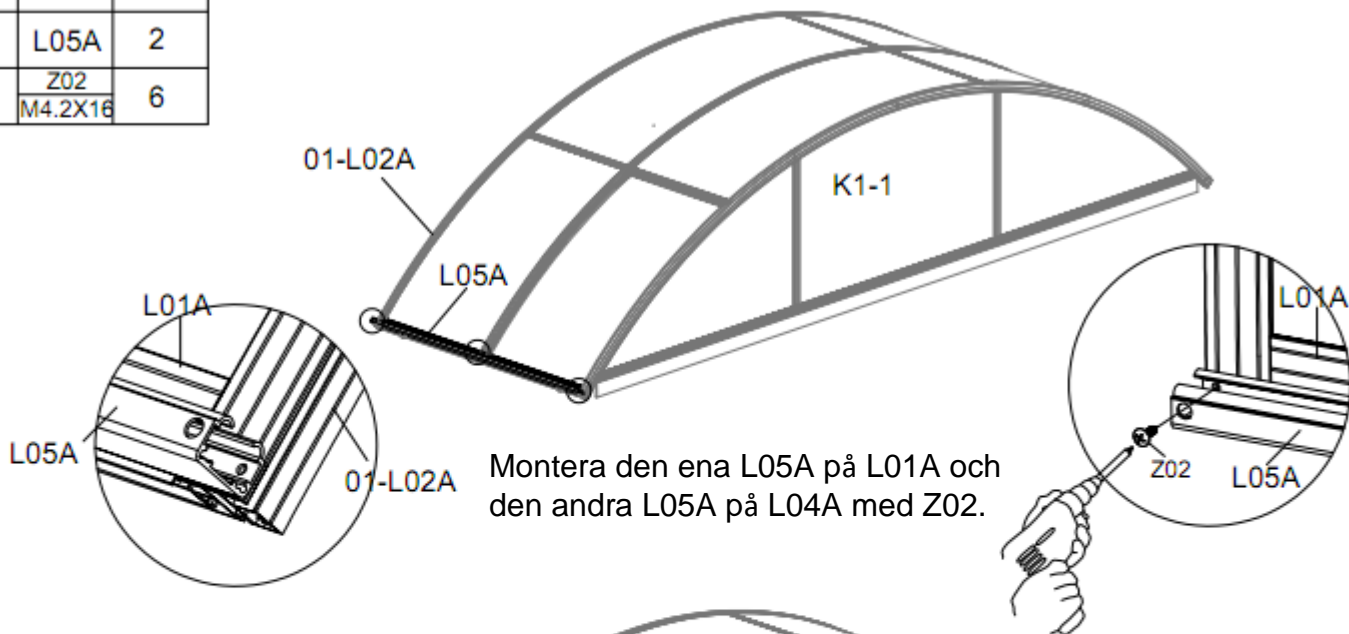

PART	NO	QTY
	01-L02G	2
	01-L02H	2
	L09A	2
	HL2	8
	Y10	1
	Z02 M4.2X16	8
	Z01 Ø6X60	8
	M01	8

Montering av fönster



PART	NO	QTY
	L05A	2
	Z02	6
	M4.2X16	



PART	NO	QTY
	CX	1
	J01	26
	Z02	2
	M4.2X16	
	Z03	2
	M4.2X25	
	Z04	8
	Ø6X16	
	W01	4
	W02	1

Montera W01 (4 st.) på båda ändarna av L05A med Z04.

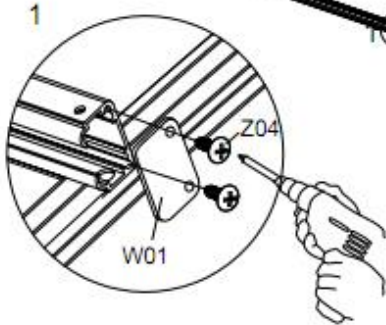
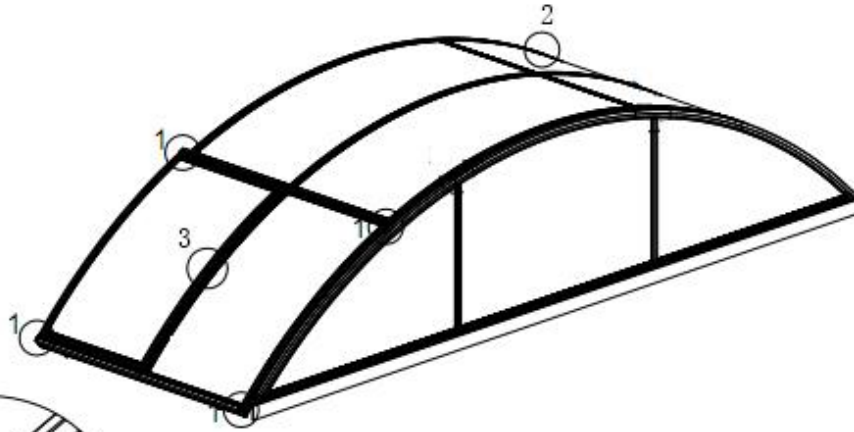

Hålen måste utvidgas till diameter 14 mm, använd en brotsch och en elskruvdragare.

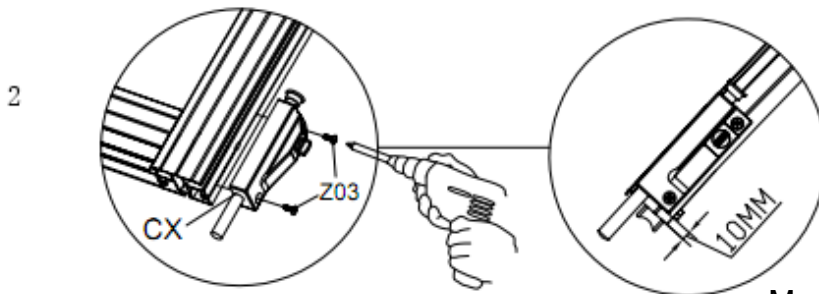

Montera CX på 01-L02A, 10 mm från nederkanten, med Z03.

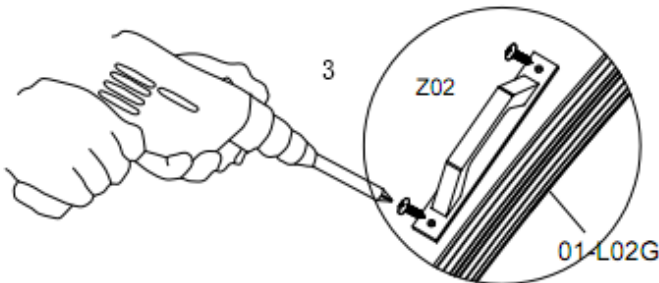



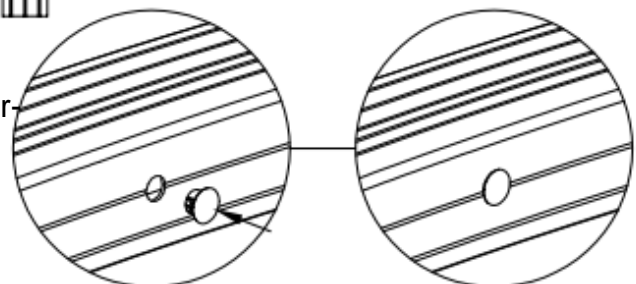



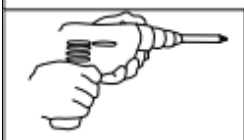







Sätt på handtaget W02 på fönsterprofilen 01-L02G med Z02.





Dölj alla hål med J01



DEL	NR.	ST.
	L01A	2
	02-L02A	2
	02-L02B	1
	L04A	4
	L11	8





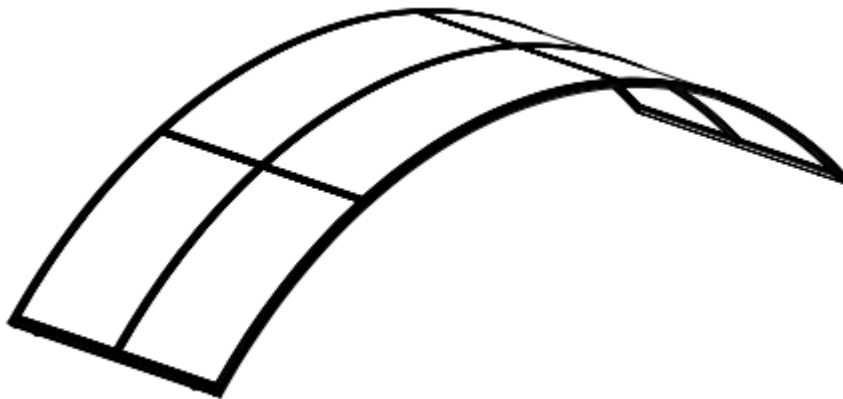

DEL	NR.	ST.
	CX	2
	J01	8
	HL	6
	S01 M6X35	6
	M01	6
	M02	6
	Z01 M6X60	12
	Z02 M4.2X16	32
	Z03 M4.2X25	4

DEL	NR.	ST.
	Y2	6

DEL	NR.	ST.
	J03	3,97 M

K2







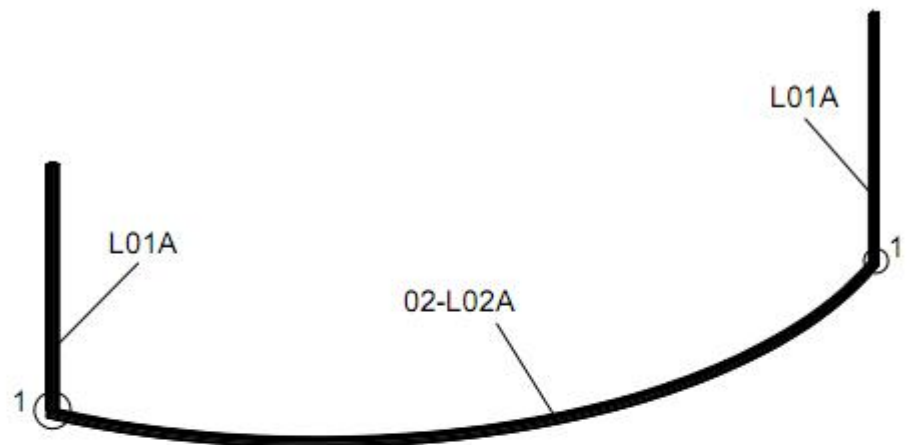
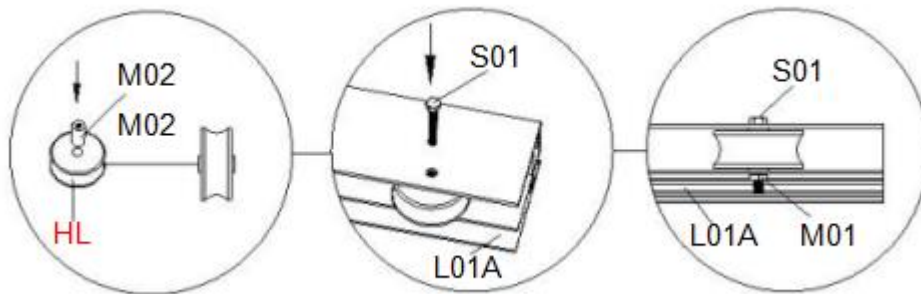
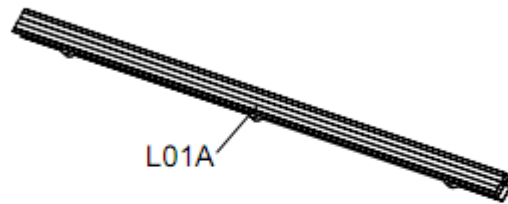

PART	NO	QTY
	L01A	2
	02-L02A	1
	HL	6
	M02	6
	S01	6
	M6X35	
	M01	6
	Z01	4
	M6X60	

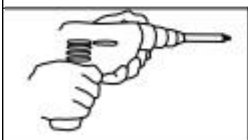
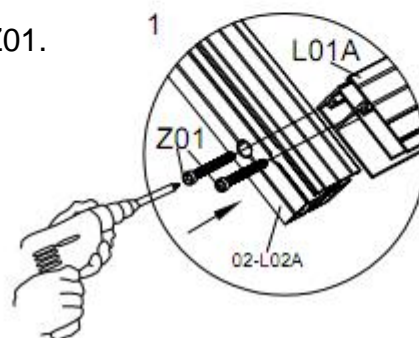
Montera hjulen på L01A (3 st.)
med S01 & M01.



Montera L01A x 2 st. på 02-L02A med Z01.







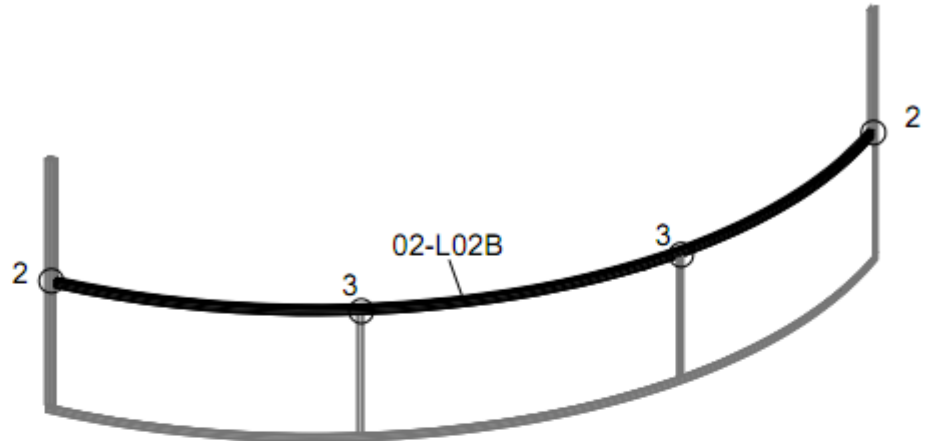
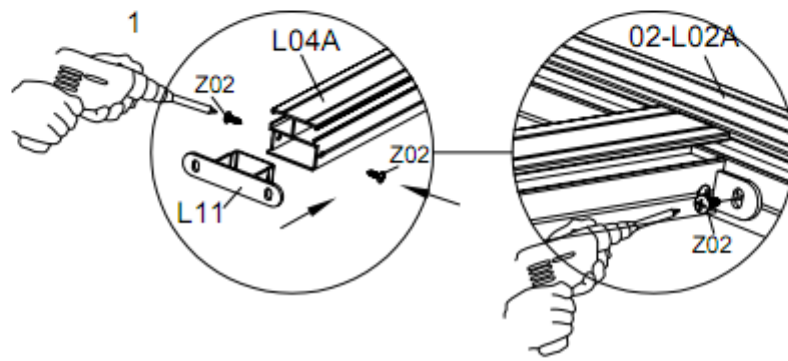
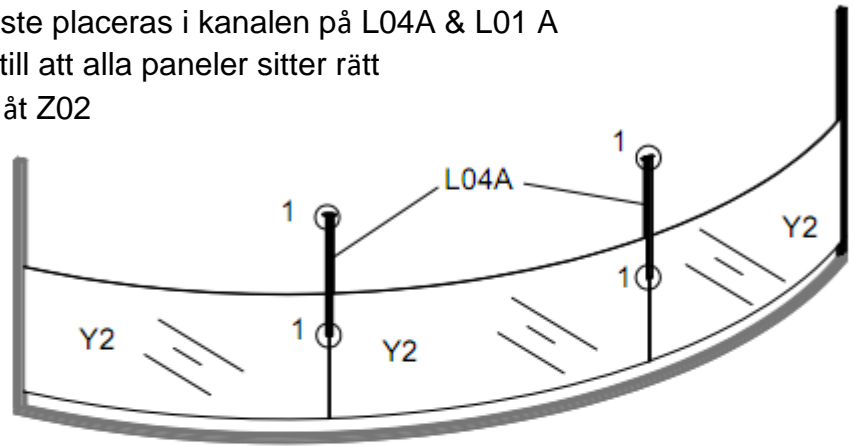

PART	NO	QTY
	L04A	2
	02-L02B	1
	L11	4
	Y2	3
	Z02	16
	Z01 M6X60	4

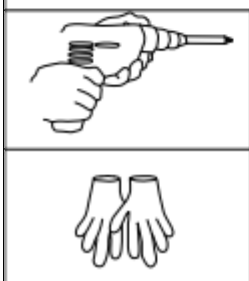
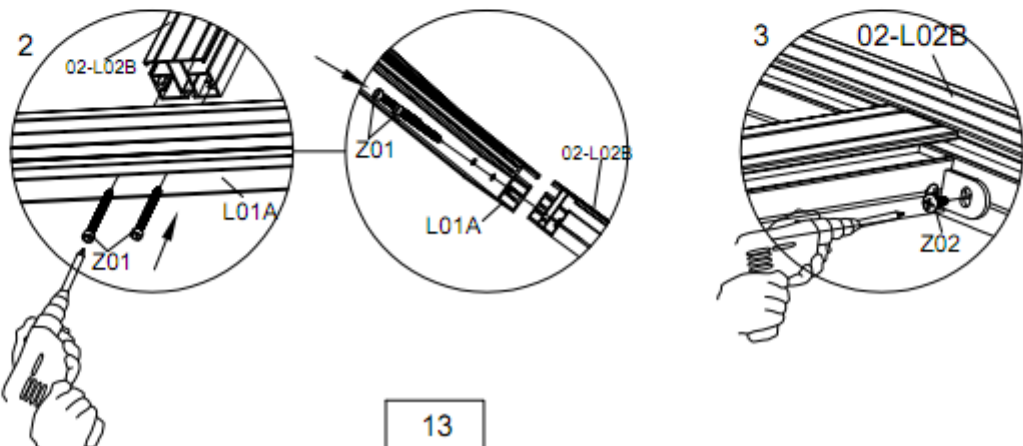
1. För in L11 i L04A, se bilden, och fixera den med Z02;
 2. Montera L04A på 02- L02A, se bilden, med Z02.
- Viktigt! Y2 måste placeras i kanalen på L04A & L01 A samtidigt. Se till att alla paneler sitter rätt innan du drar åt Z02 ordentligt.





Montera ihop 02-L02B med L01A och L04A, använd Z01 & Z02.

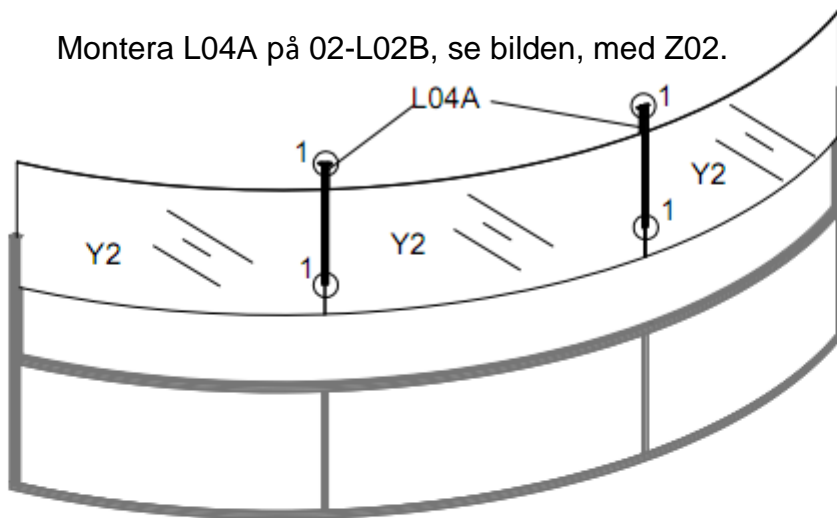

PART	NO	QTY
	02-L02A	1
	L04A	2
	L11	4
	Y2	3
	Z02	16
	Z01 M6X60	4

Montera L04A på 02-L02B, se bilden, med Z02.



PART	NO	QTY
	J03	3.97M

Viktigt!
Y2 måste placeras
i kanalen
på L04A/L01A
samtidigt.
Se till att alla
panelerna sitter på
rätt position innan
du drar åt Z02
ordentligt.

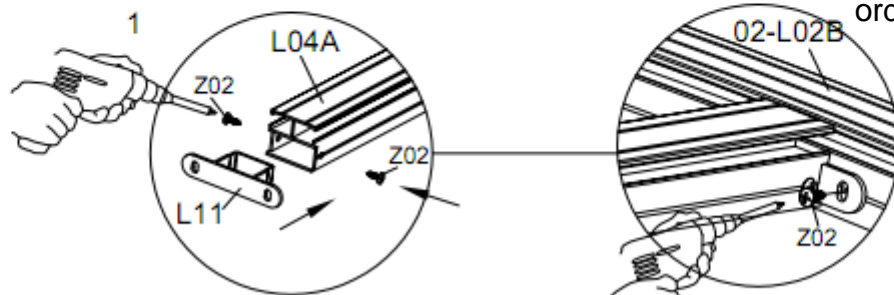



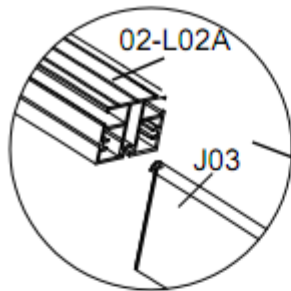

För in L11 i L04A, se bilden,
och fixera den på L04A med Z02;

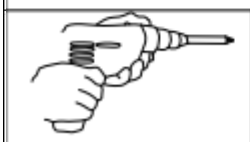
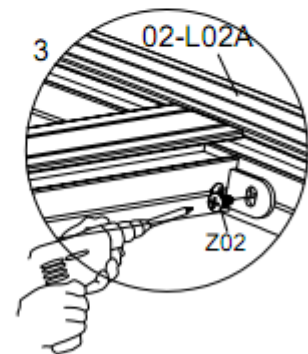
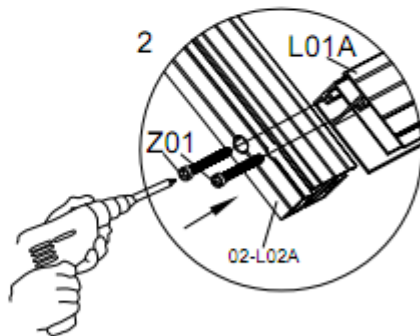
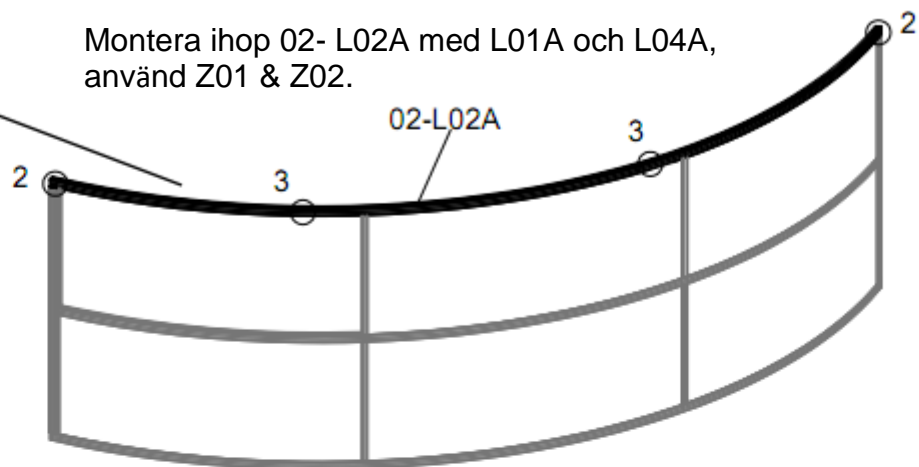

För in gummit J03 i
kanalen på 02-L02A.

Montera ihop 02- L02A med L01A och L04A,
använd Z01 & Z02.



PART	NO	QTY
	CX	2
	J01	8
	Z03 M4.2X25	4

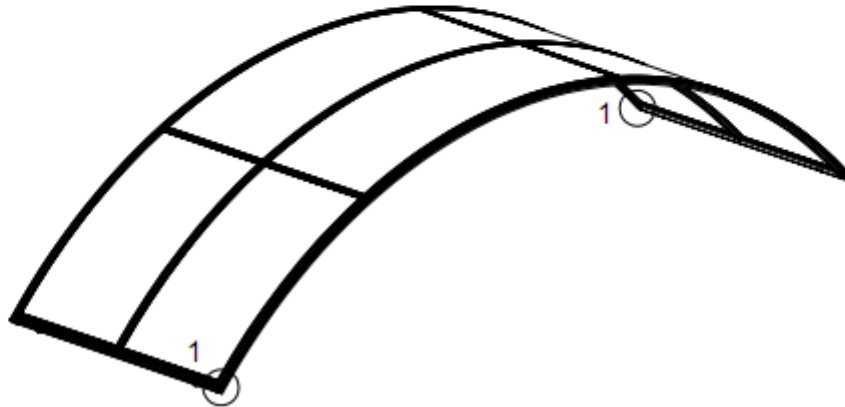



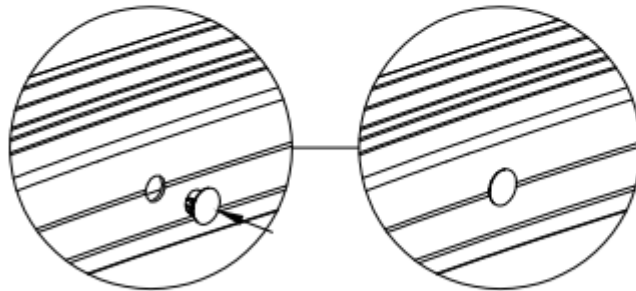
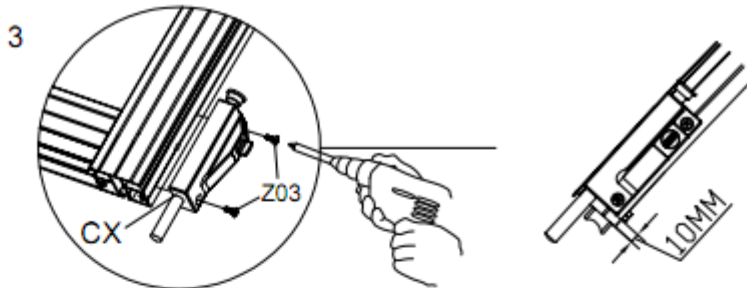



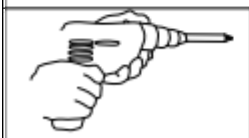









Montera CX (2 st.) på 02-L02A, 10 mm från nederkanten, med Z03.



Dölj alla hål med J01











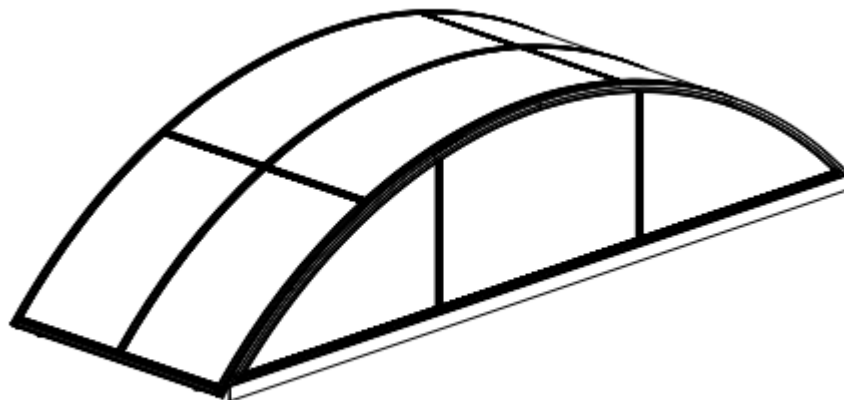

DEL	NR.	ST.
	L01A	2
	03-L02A	1
	03-L02B	1
	L04A	4
	L08B	1
	L11	8
	K3-1	1

DEL	NR.	ST.
	CX	1
	J01	12
	HL	6
	S01 M6X35	6
	M01	6
	M02	6
	Z01 M6X60	12
	Z02 M4X16	37
	Z03 M4.2X25	2

DEL	NR.	ST.
	Y3	6

K3



PART	NO	QTY
	L01A	2
	K3-1	1
	L08B	1
	HL	6
	M02	6
	S01 M6X35	6
	M01	6
	Z01 Ø6X60	4
	Z02 M4.2X16	5

Montera hjulen på L01A (3 st.)
med S01 & M01.

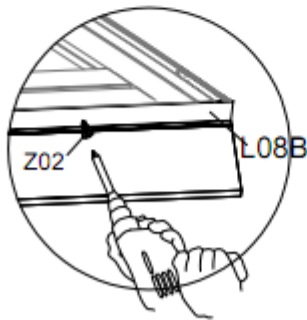
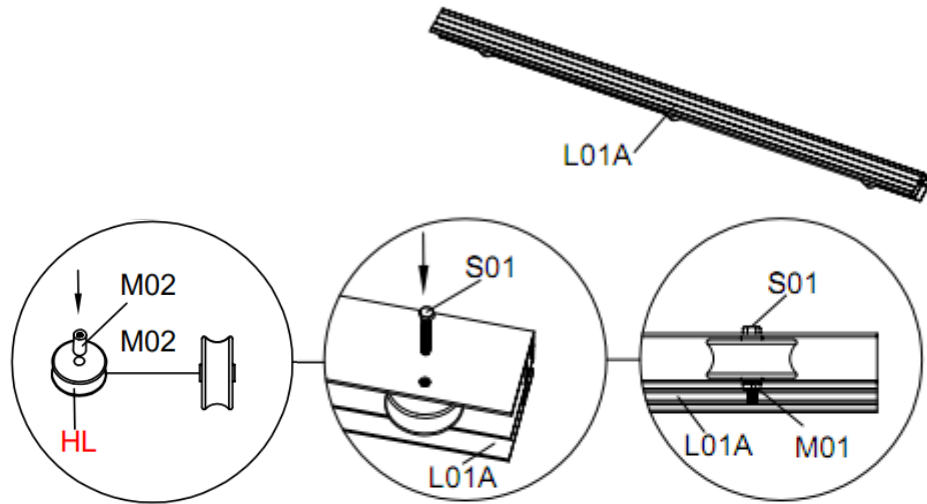

Montera L08B på K3-1 med Z02.

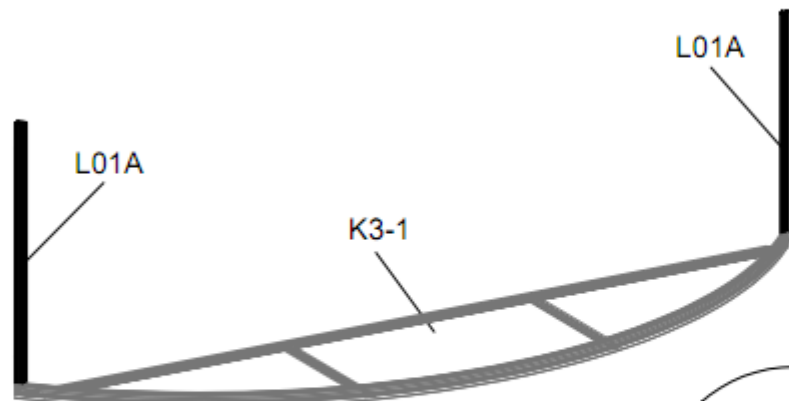

Montera L01A x 2 st. på K3-1 med Z01.

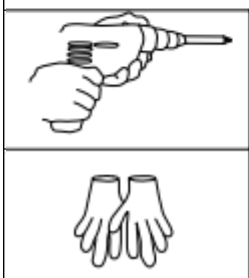
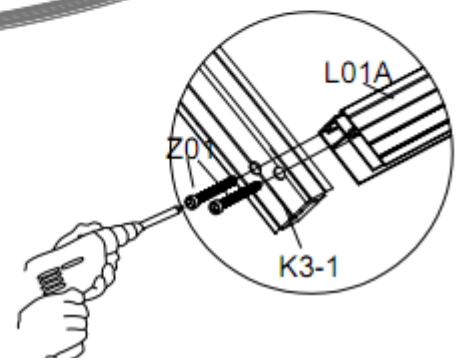

PART	NO	QTY
	L04A	2
	03-L02B	1
	L11	4
	Y3	3
	Z02	16
	M4X16	
	Z01	4
	M6X60	

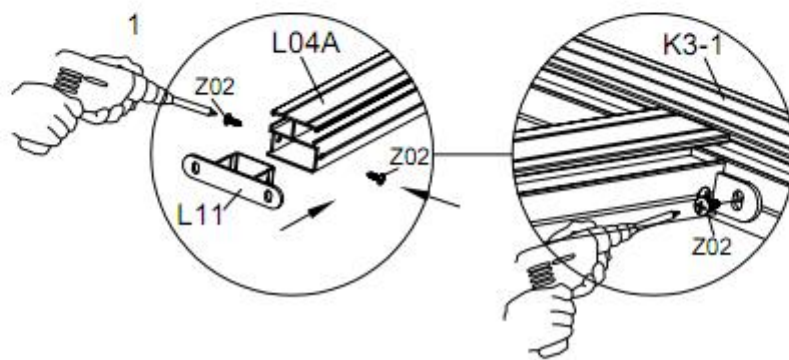
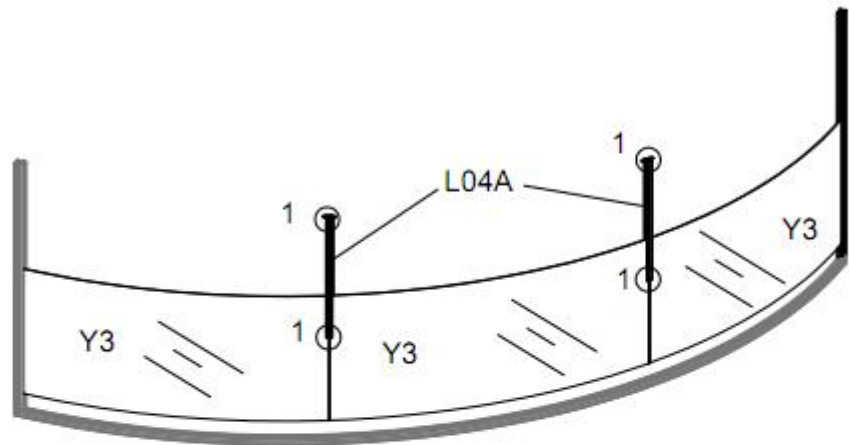



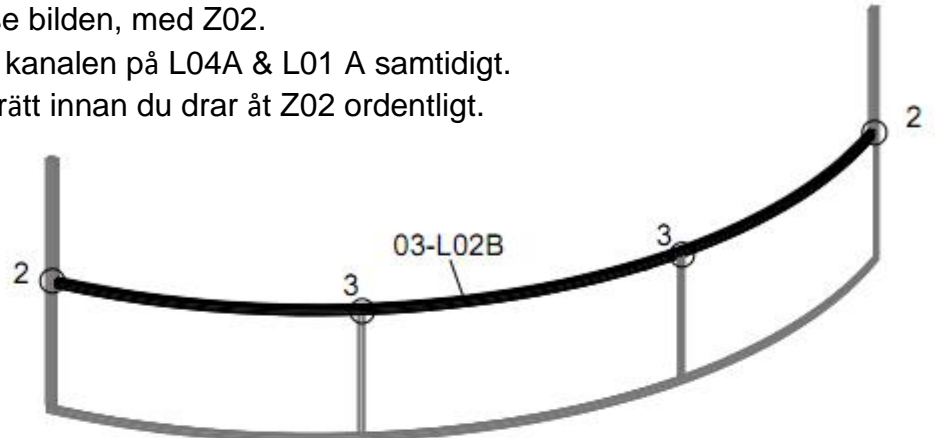

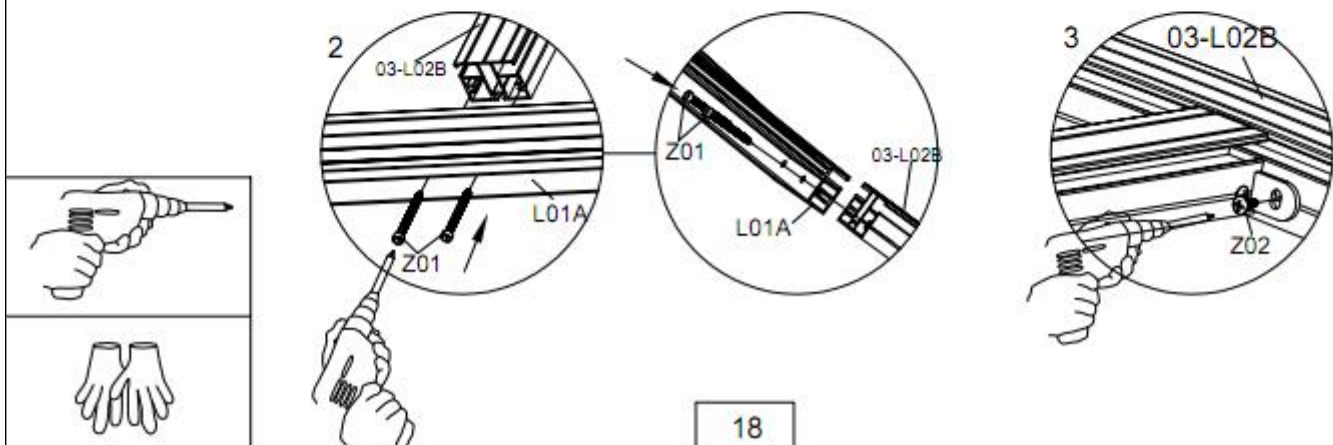

1. För in L11 i L04A, se bilden, och fixera den med Z02;
 2. Montera L04A på K3-1, se bilden, med Z02.
- Viktigt! Y3 måste placeras i kanalen på L04A & L01 A samtidigt.
Se till att alla paneler sitter rätt innan du drar åt Z02 ordentligt.



Montera ihop 03-L02B med L01A och L04A, använd Z01 & Z02.



PART	NO	QTY
	03-L02A	1
	L04A	2
	L11	4
	Y3	3
	Z02	16
	M4X16	
	Z01	4
	M6X60	

Montera L04A på 03-L02B, se bilden, med Z02.

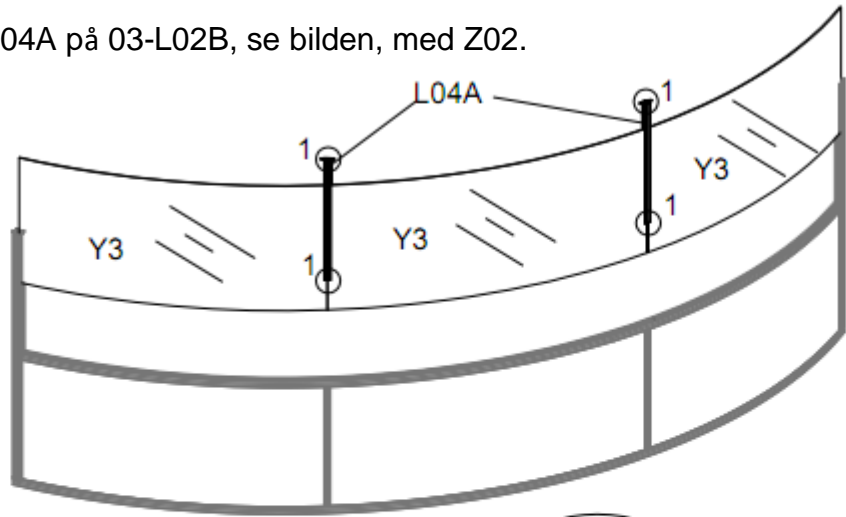

Viktigt!

Y3 måste placeras i kanalen på L04A/L01A samtidigt. Se till att alla panelerna sitter på rätt position innan du drar åt Z02 ordentligt.

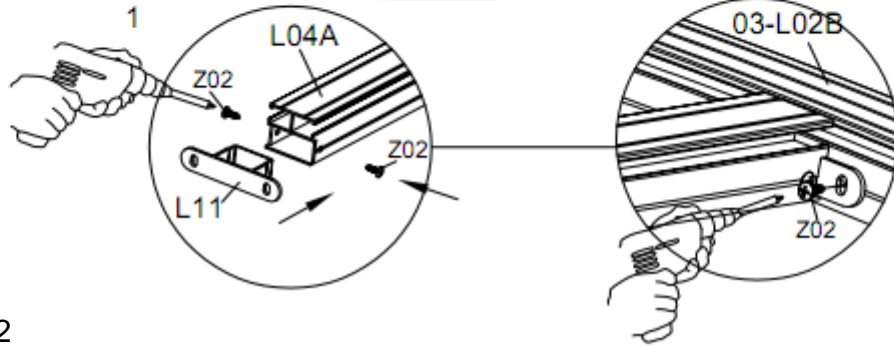

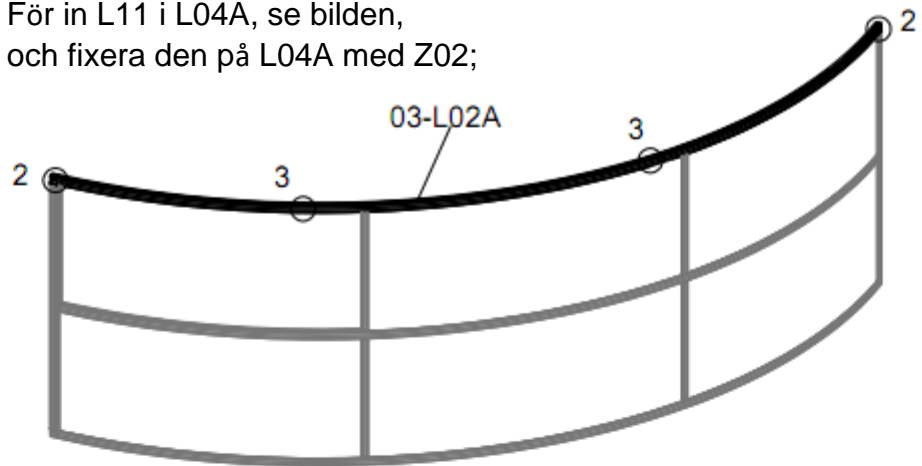

För in L11 i L04A, se bilden, och fixera den på L04A med Z02;

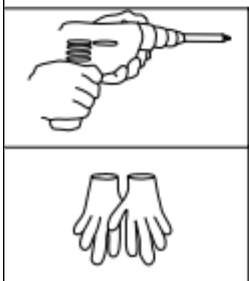
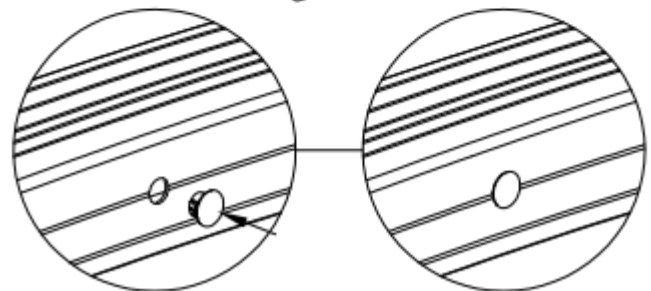
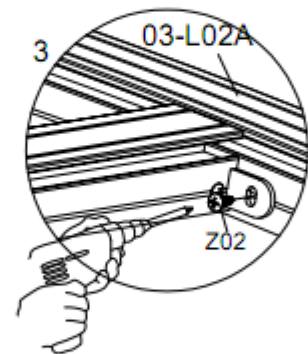
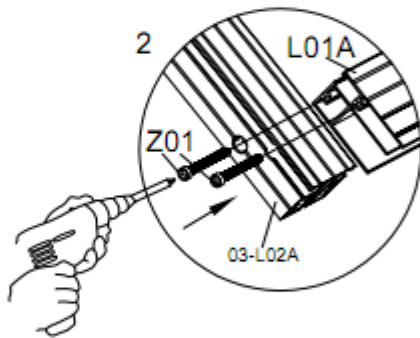

Montera ihop 03-L02A med L01A och L04A, använd Z01 & Z02.



Dölj alla hål med J01

PART	NO	QTY
	CX	1
	J01	12
	Z03 M4.2X25	2

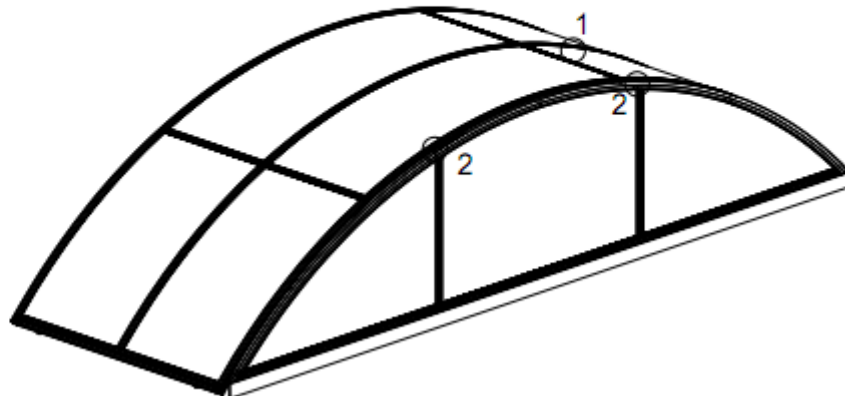

Montera CX på 03-L02A, 10 mm från nederkanten, med Z03.

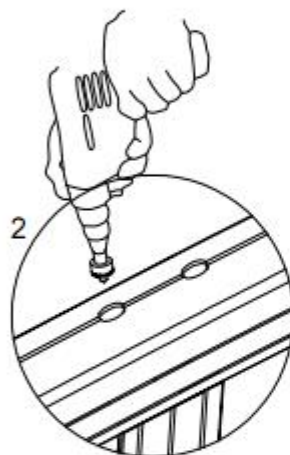
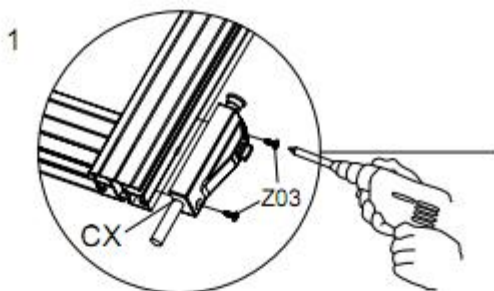



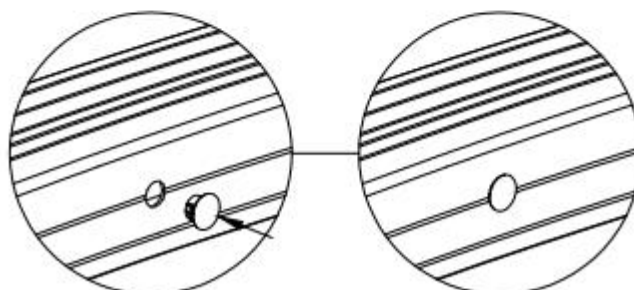

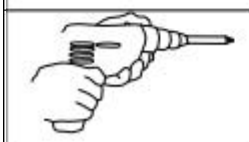

Hålen måste utvidgas till diameter 14 mm, använd en brotsch och en elskruvdragare.



Dölj alla hål med J01



DEL	NR.	ST.
	L06A	12
	L12	6
	L13	4
	J02	60
	J04	4
	S02 M6X80	60
	Z02 M4.2X16	24

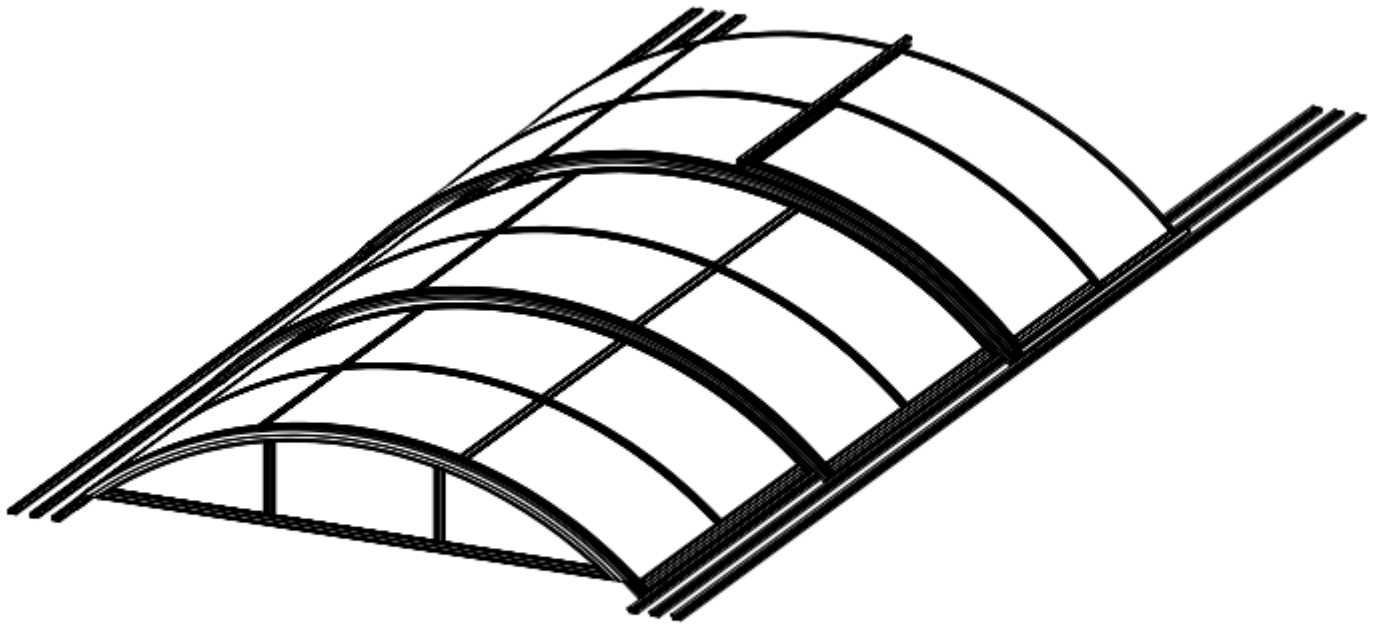

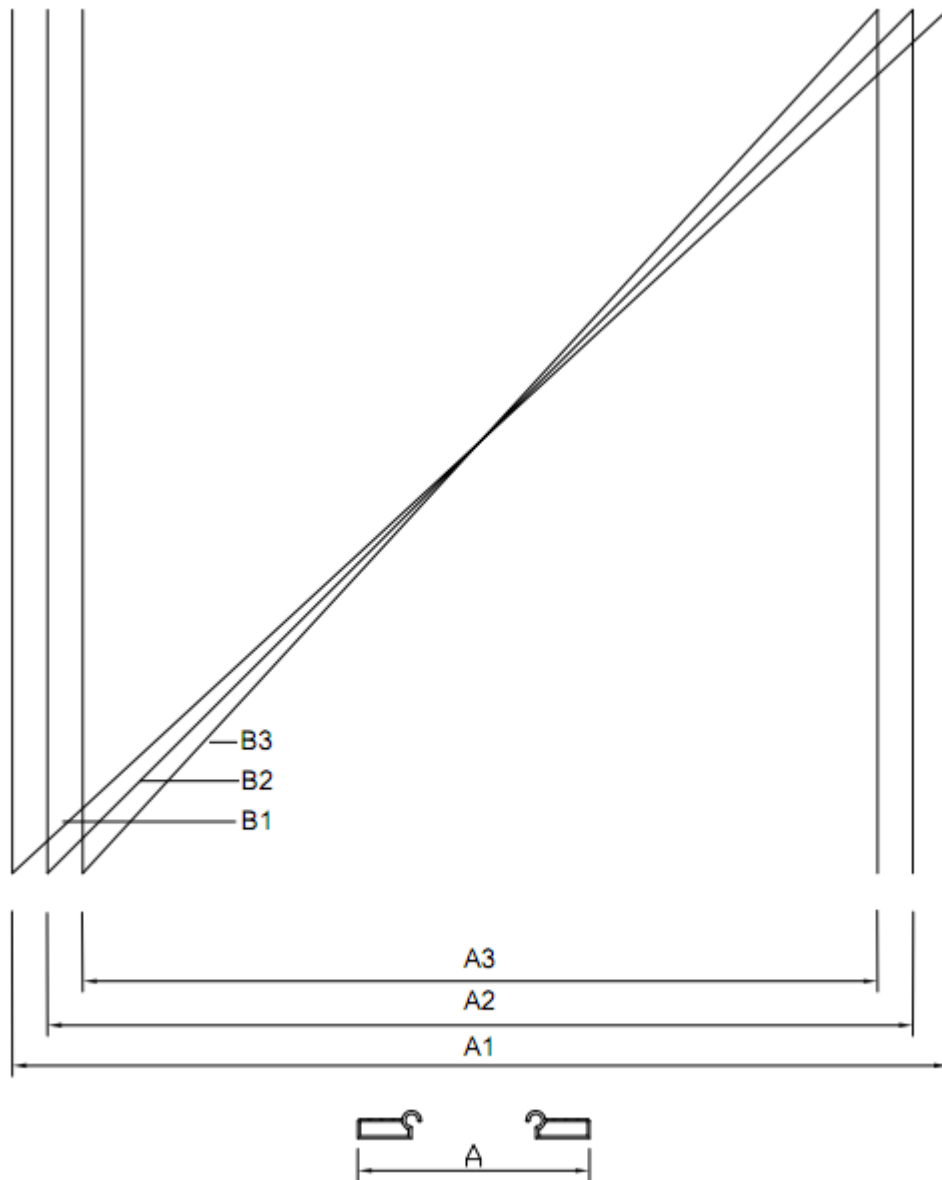

NR. mm	1	2	3
A (mm)	3 906	3 654	3 402
B (mm)	9 355	9 252	9 156

Mindre avvikelser mellan måtten här och i verkligheten är tillåtna.

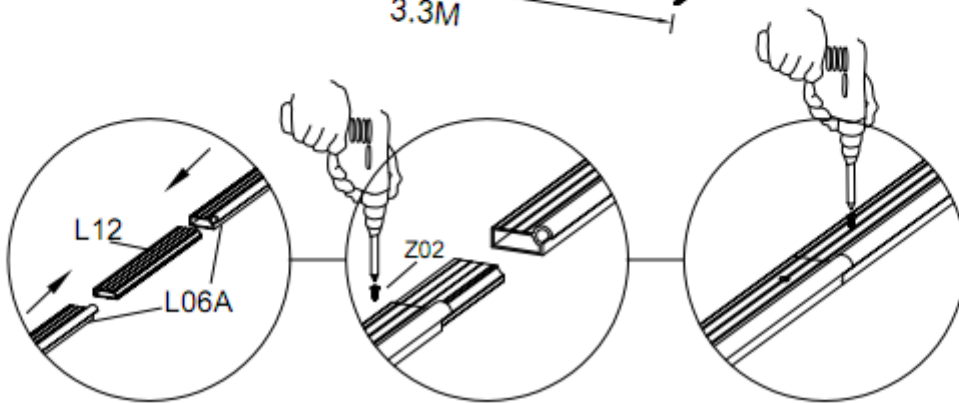
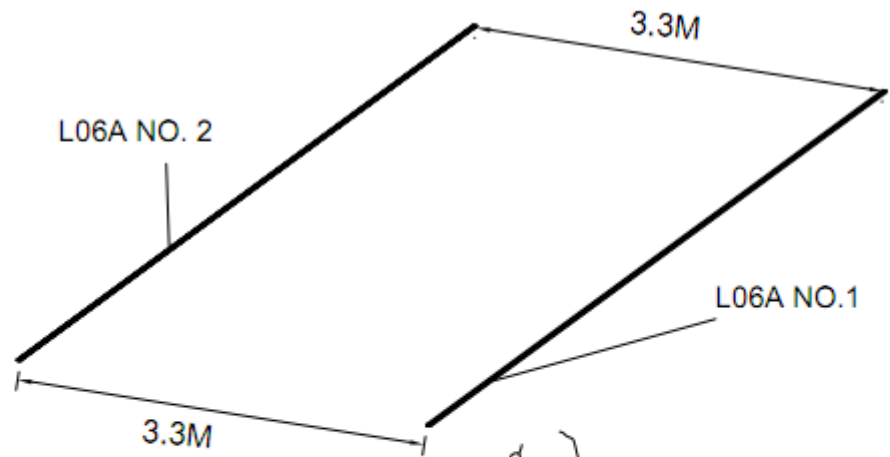

Sätt samman 2 st. L06A-delar till en förlängd del genom att föra in L12 i båda ändarna och fixera dem med Z02.

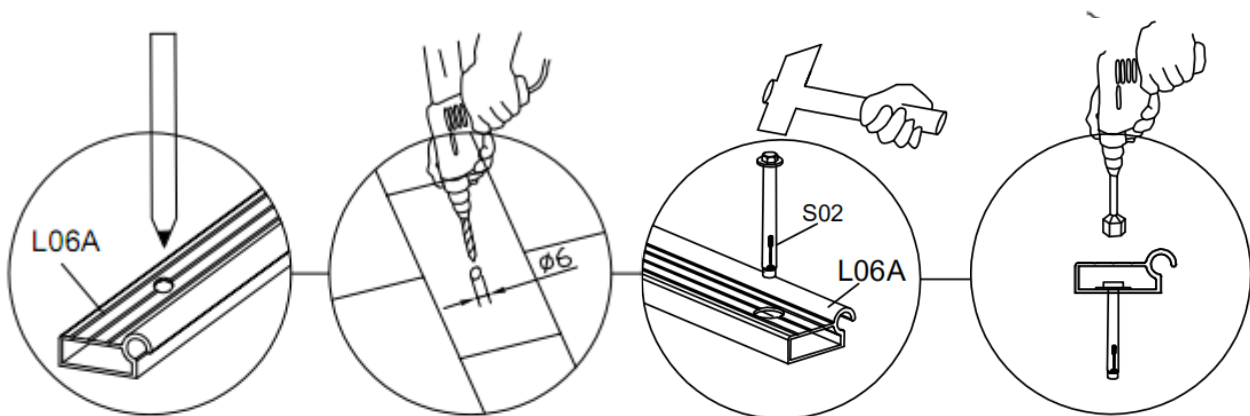

1. Lägg ut 2 st. förlängda L06A-delar på underlaget med rätt avstånd, se ovan.
2. Markera med en penna på den ena L06A-delen genom att föra pennan genom hålen i den andra L06A-delen. Borra sen hål med diameter 6 mm i underlaget.
3. Slå i S02 i hålen och fixera L06A-del 1 på underlaget genom hålen med Z01.
4. Kontrollera att det inre avståndet mellan L06A-del 2 är 3 300 mm från L06A-del 1, och att det yttre avståndet mellan dem är 3 402 mm.
5. Fäst inte L06A-del 2 i underlaget förrän K3 går att flytta smidigt i de två spåren.

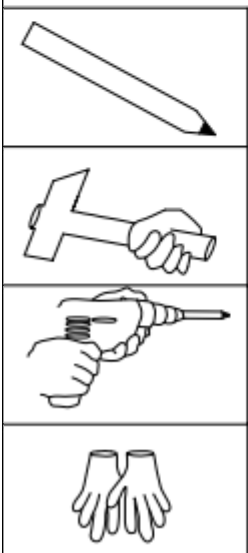
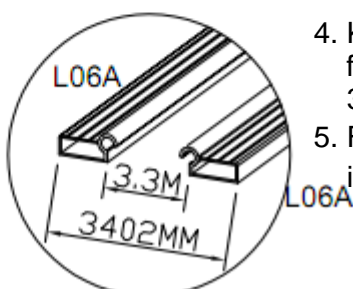

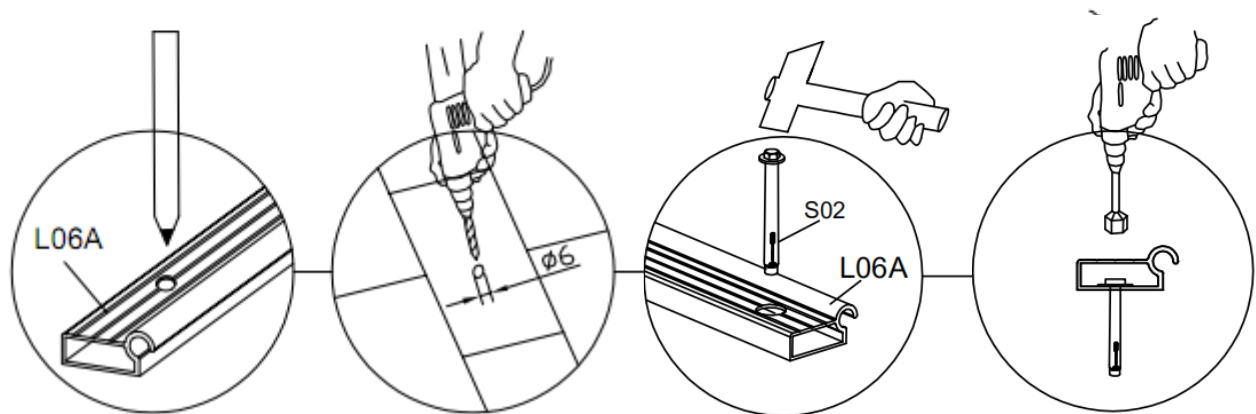
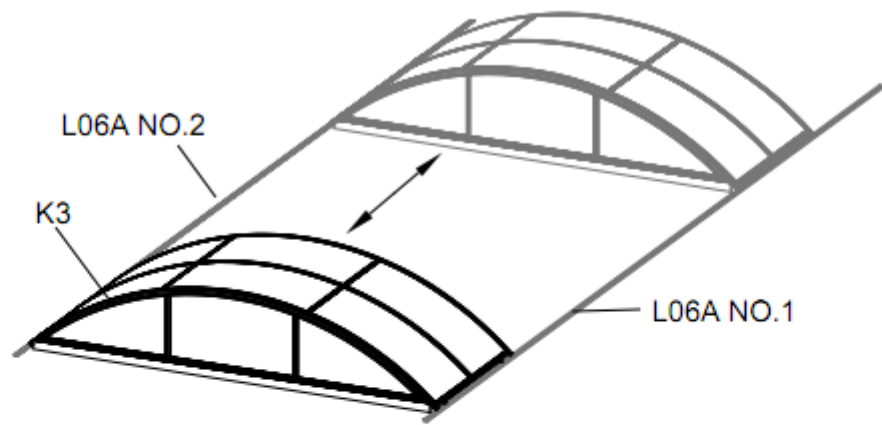

1. Placera K3 i de två spåren och justera L06A-del 2 tills K3 går att flytta smidigt.
2. Markera med en penna på underlaget genom hålen i L06A-delen. Borra sen hål med 6 mm diameter i underlaget.
3. Slå i S02 i hålen och fixera L06A-del 2 i underlaget genom hålen med Z01.

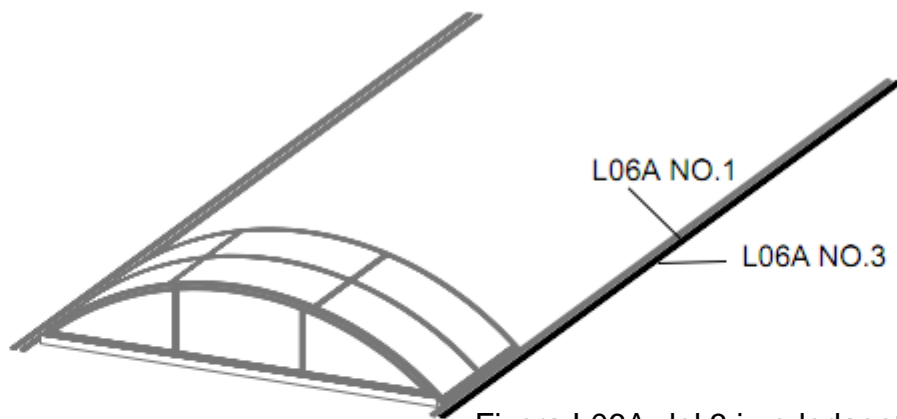

Fixera L06A-del 3 i underlaget, se ovan, 126 mm från L06A-del 1, se nedan.

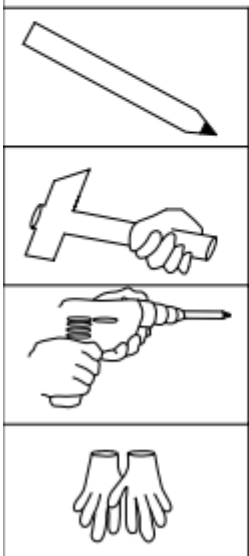
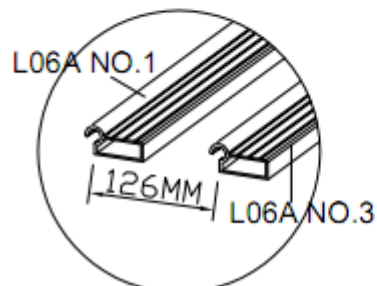

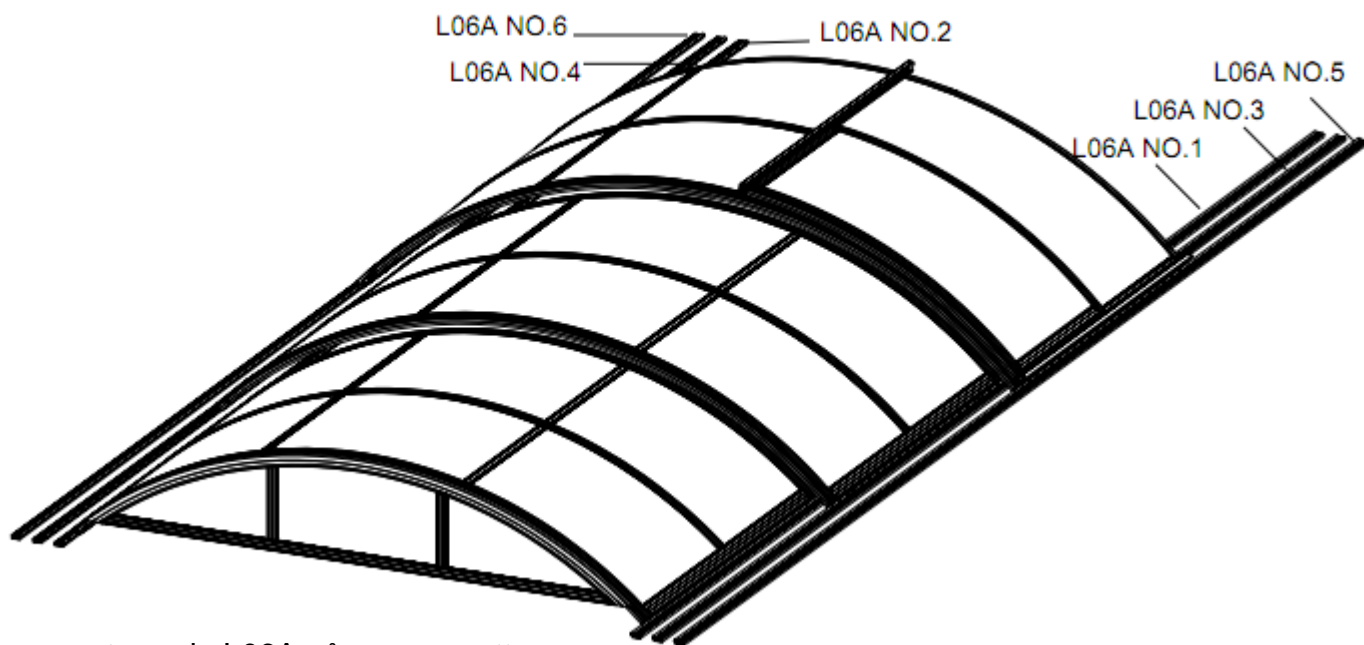

Fixera resterande L06A på samma sätt som ovan.
Se till att alla delar av pooltaket går att flytta smidigt innan du drar åt skruvorna ordentligt.

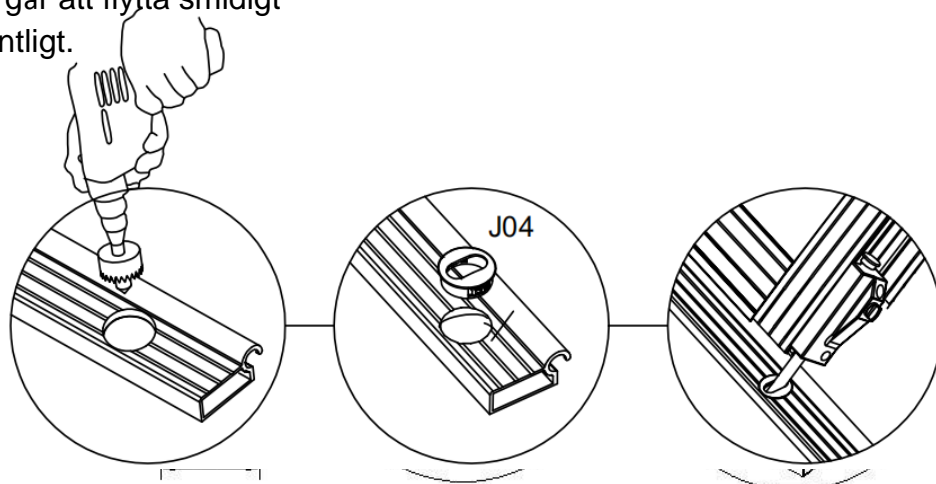

Borra 4 ovala hål (30 mm) i L06A, motsvarande de 4 låsen (CX).
På så sätt kan du låsa pooltaket när du stänger det.

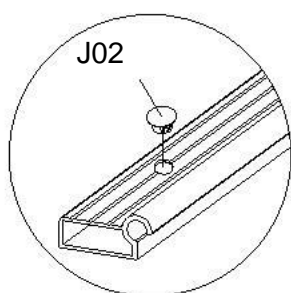

Dölj alla hålen i L06A med J02

Konsumentkontakt
Arc E-commerce AB
Box 3124
13603 Haninge
Sverige

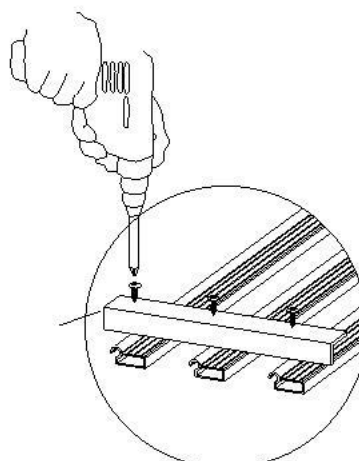

Sist av allt fäster du L13
(4 st.)
på ändarna av L06A
med Z02.

