

















MANUAL VINDSKYDD 4x4m







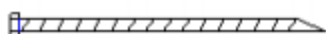

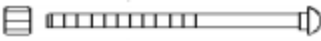

Monteringen bör utföras av minst två personer.

Använd handskar under monteringen. Metallkomponenterna är behandlade med en rostskyddsbeläggning som kan kännas oljig vid beröring. Denna beläggning är helt ofarlig men kan smutsa ner händer under motering. Vi rekommenderar att du rengör metallkomponenter med hjälp av en trasa och en varm diskmedelslösning. Blir din händer smutsiga är det bara tvätta dig med tvål och vatten.

Lista över delar

Del Nr.	Benämning	Bild	Antal
Nr.1	Övre tvärstång		
Nr.2	Sido-tvärstång		
Nr.3	Påle		
Nr.4	Påle		
Nr.5	Påle		
Nr.6	Påle		
Nr.7	Takläkt		0
Nr. 8	Staket		
Nr.9	Påle		
Nr.10	Påle		
Nr.11	Staket		
Nr.12	Fotplatta		
Nr.13	Fotplatta		
Nr.14	Fotplatta		
Nr.15	Pinne		
Nr.16	Tak		1

Nr.18	Vägg		
Nr.19	Rep		0m
Nr.20	M8x70 Bult		
Nr.21	M8x60 Bult		
Nr.22	M8x70 Bult		
Nr.23	M10x30 Bult		
Nr.24	Buntband		
Nr.25	Vinkelfäste		1

Steg 1.

Placera ut fotplattor.

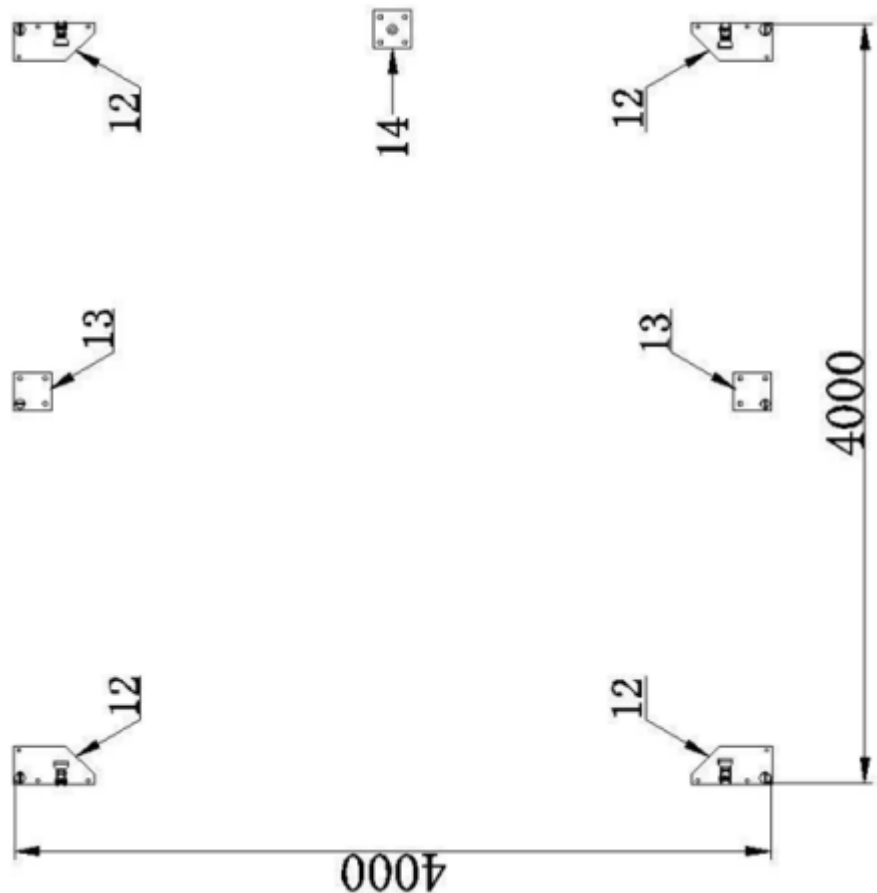

Steg 2.
Montera
ihop första
bågen
(öppningen
).

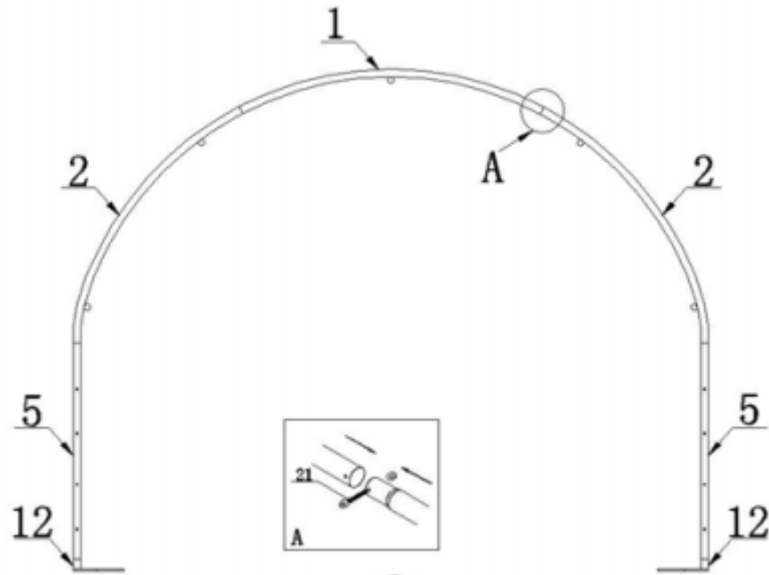

Steg 3.
Montera
ihop andra
bågen
(mittbågen
).

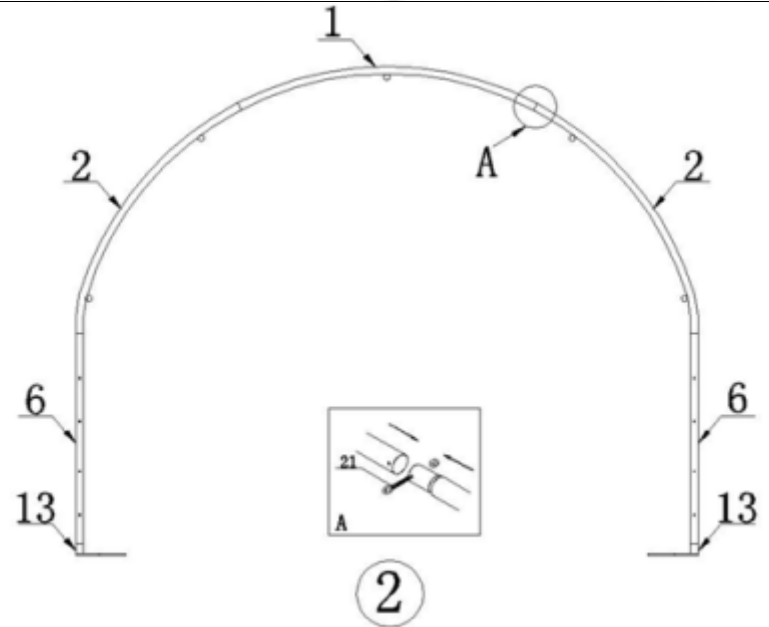

Steg 4.
Montera
ihop
sista
bågen
(skydde
ts bakre
vägg).

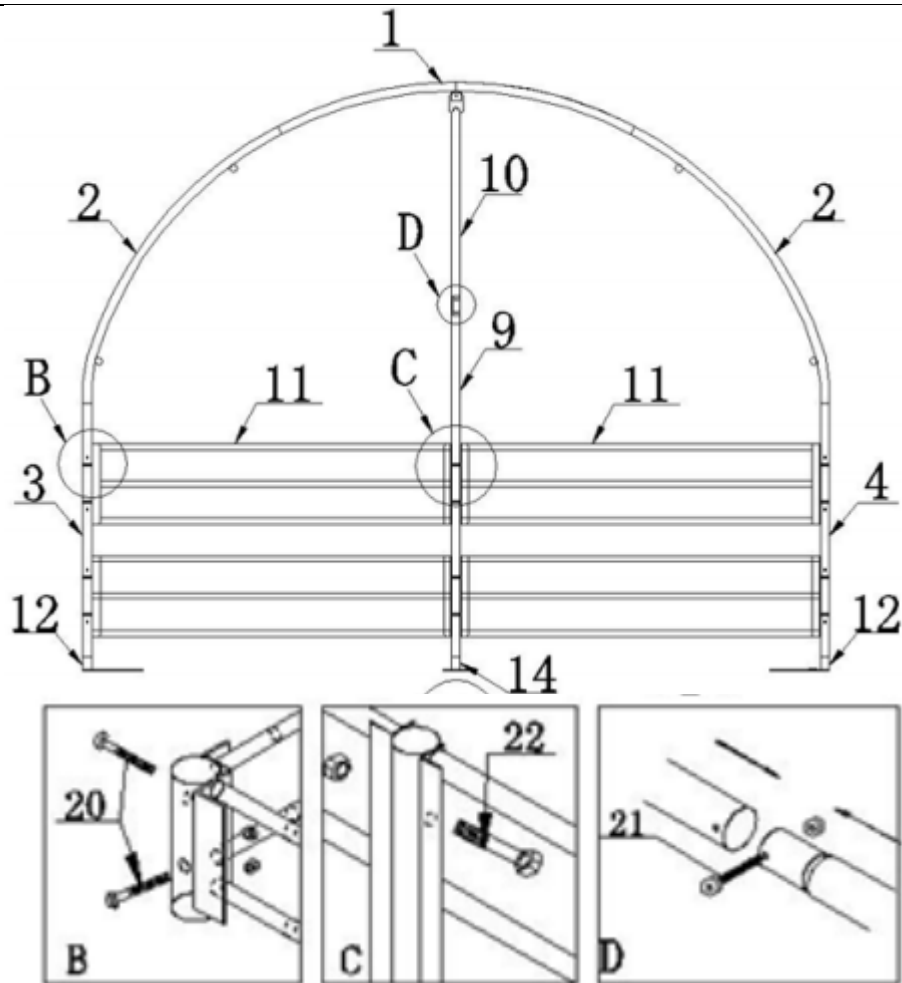

D

10'g''

Steg 5
Inriktning
av ramen
och
fastsättning
av
fotplattor
med
pinnar.

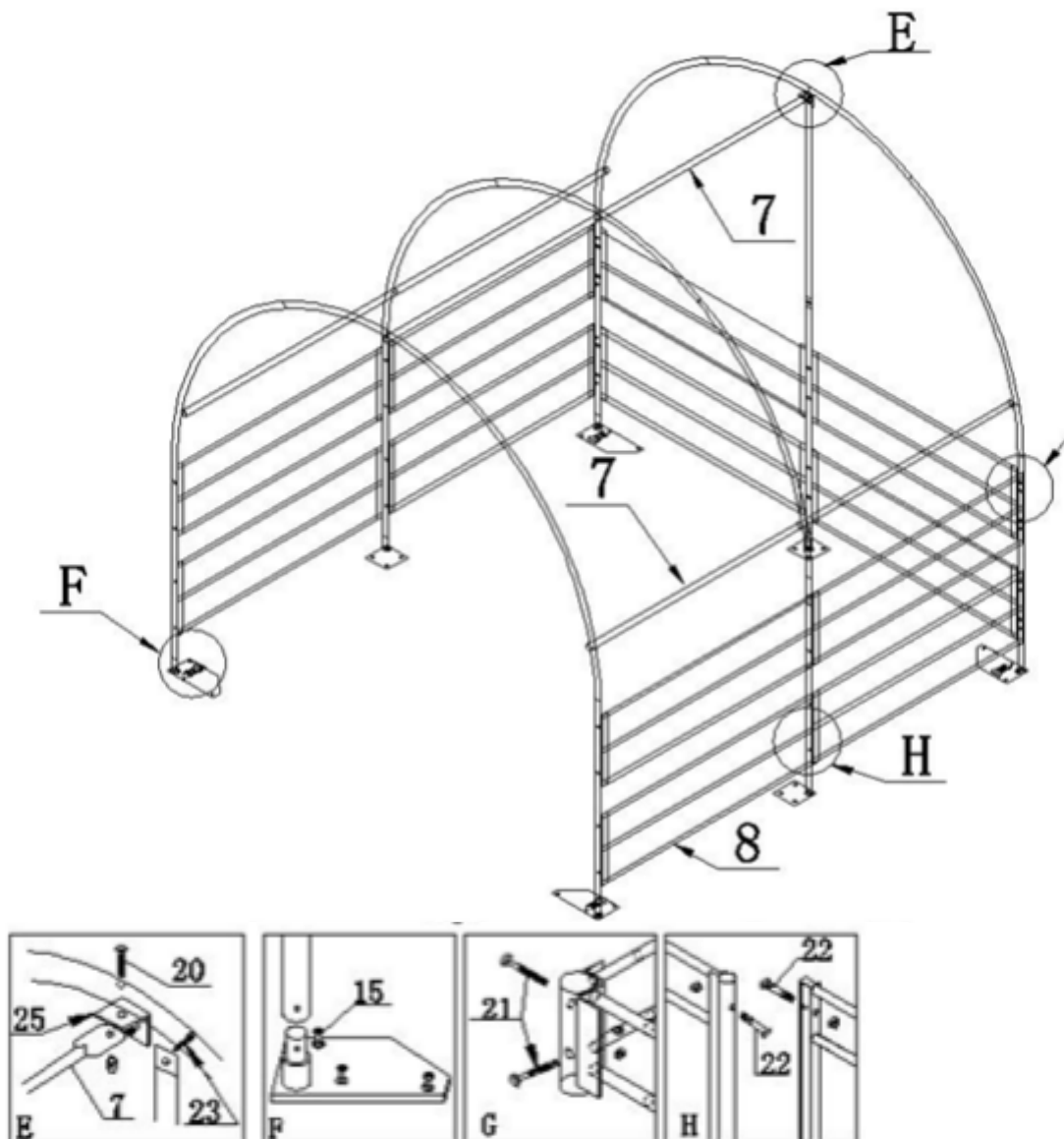

Steg 6
Installera
väggen.

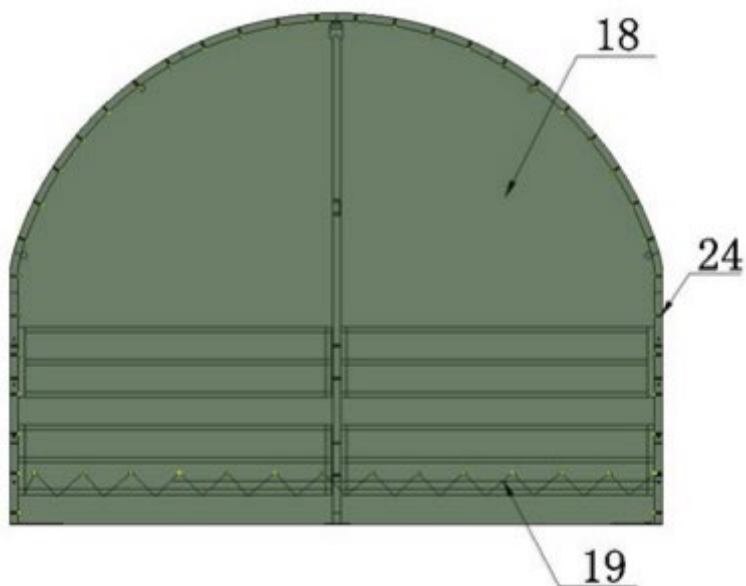

Steg 7
Tak och
sidovägg
(sidovägg
ingår ej -
kan köpas
som
tillval)

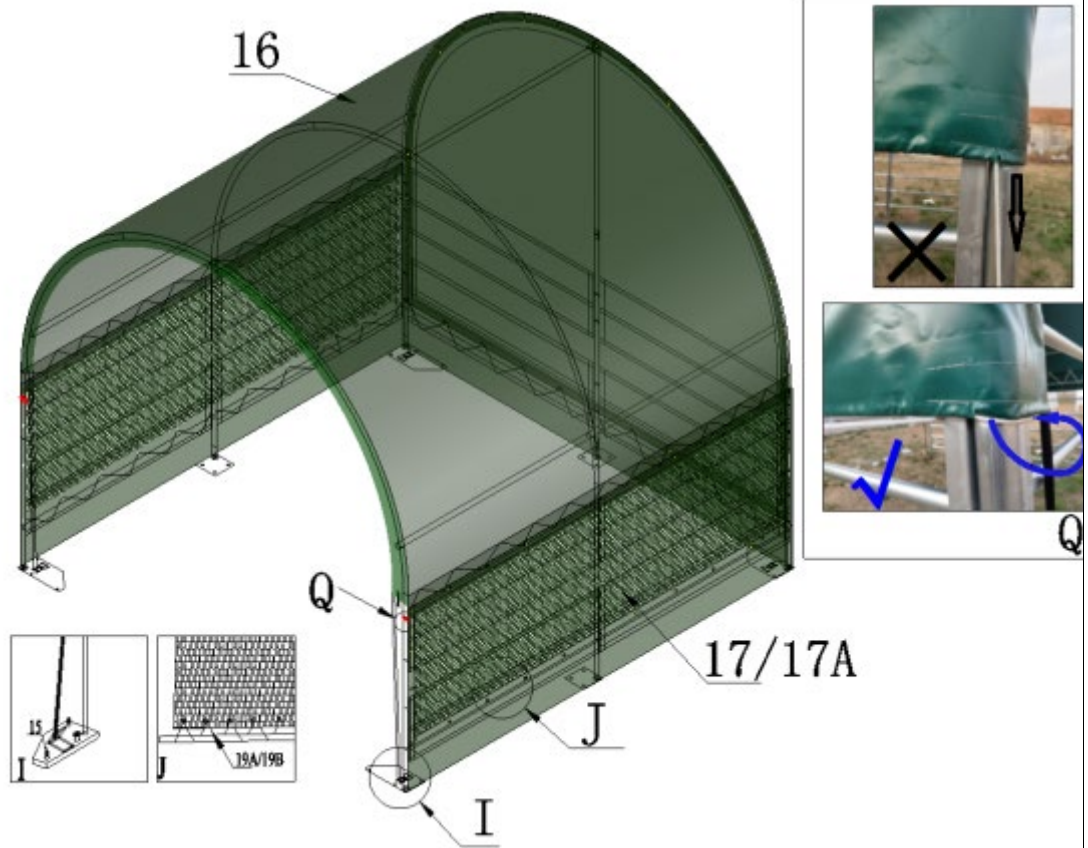

Konsumentkontakt
Arc E-commerce AB
Box 3124
13603 Haninge
Sverige