

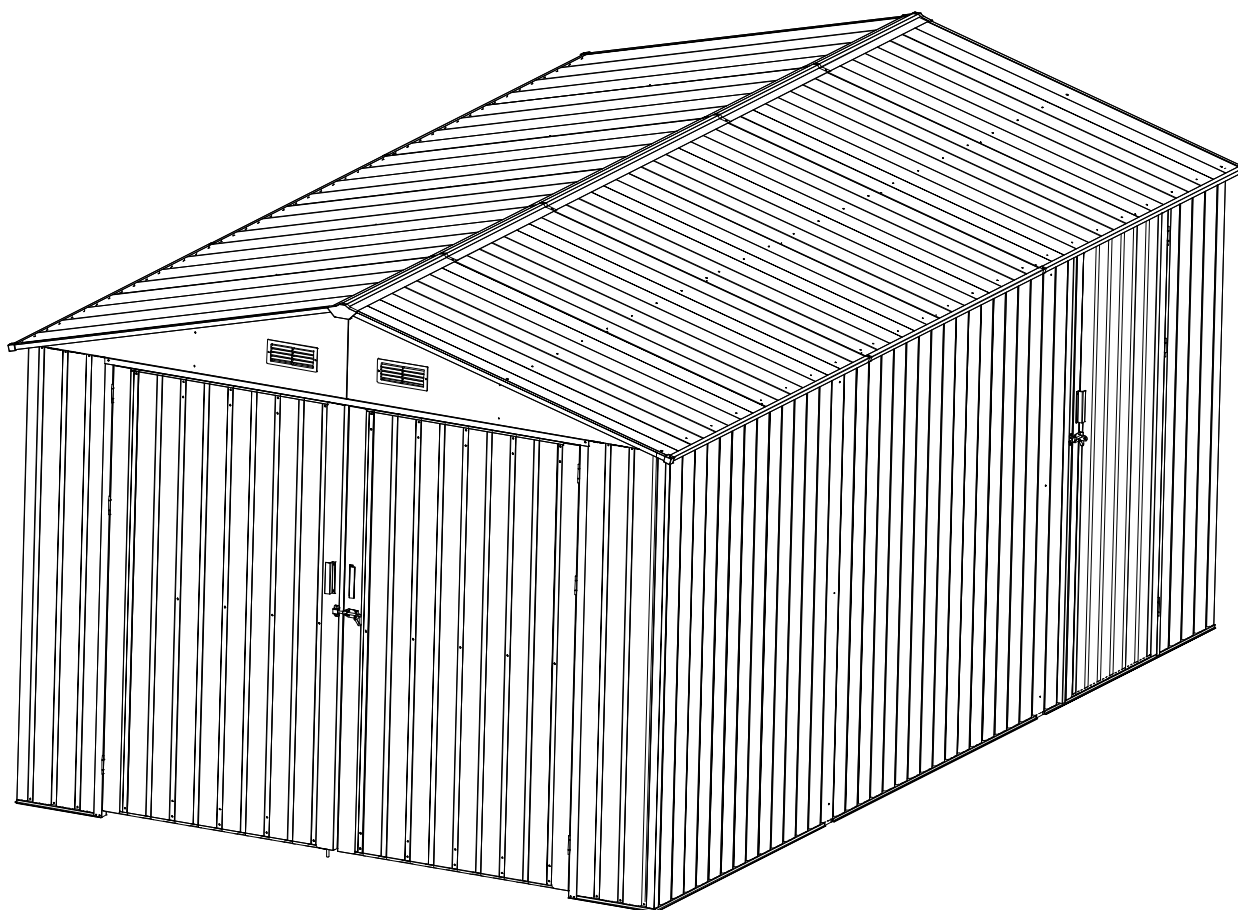





























































PLÅTGARAGE























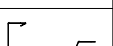
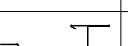
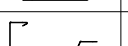
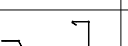





BRUKSANVISNING



LISTA ÖVER DELAR

DEL	NR.	ST.
	1	2
	2	2
	3	2
	3L	1
	3R	1
	4L	1
	4R	1
	5L	1
	5R	1
	6L	1
	6R	1
	7	1
	8	2
	9	2
	10L	1
	10R	1
	11	2
	12L	1
	12R	2
	12	4
	13	4
	14	4
	15	6
	16	2
	17	2
	7L	1
	7R	1
	18	2
	19	7

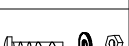
DEL	NR.	ST.
	21L	2
	21R	2
	22	2
	23	1
	24	2
	25L	1
	25R	1
	35	1
	31	4
	32	4
	33	4
	34	2
	B1	2
	B2	2
	B3	4
	J4	2
	L1	16
	P1	9
	P2	2
	P3	2
	P4	1
	P5	1
	P6	1
	P7	1
	P6L	1
	P6R	1
	P4L	8
	P4R	6
	F5	100
	GC	4
	GE	2
	GF	4

DEL	NR.	ST.
	D1	2
	D2	1
	30	4
	29	4
	29-1	4
	36	1
	37	1
	38	1
	39	1
	40	1
	41	1
	42	2
	43	4
	44	1
	45	1
	46	1
	47	1
	48	2
	49	2
	50	2
	J1	4
	J2	4
	J3	2
	B5	3
	B6	9
	H1	2
	H2	2
	J5	1
	J6	1
	F1	900
	F2	200
	F3	40
	F4	17

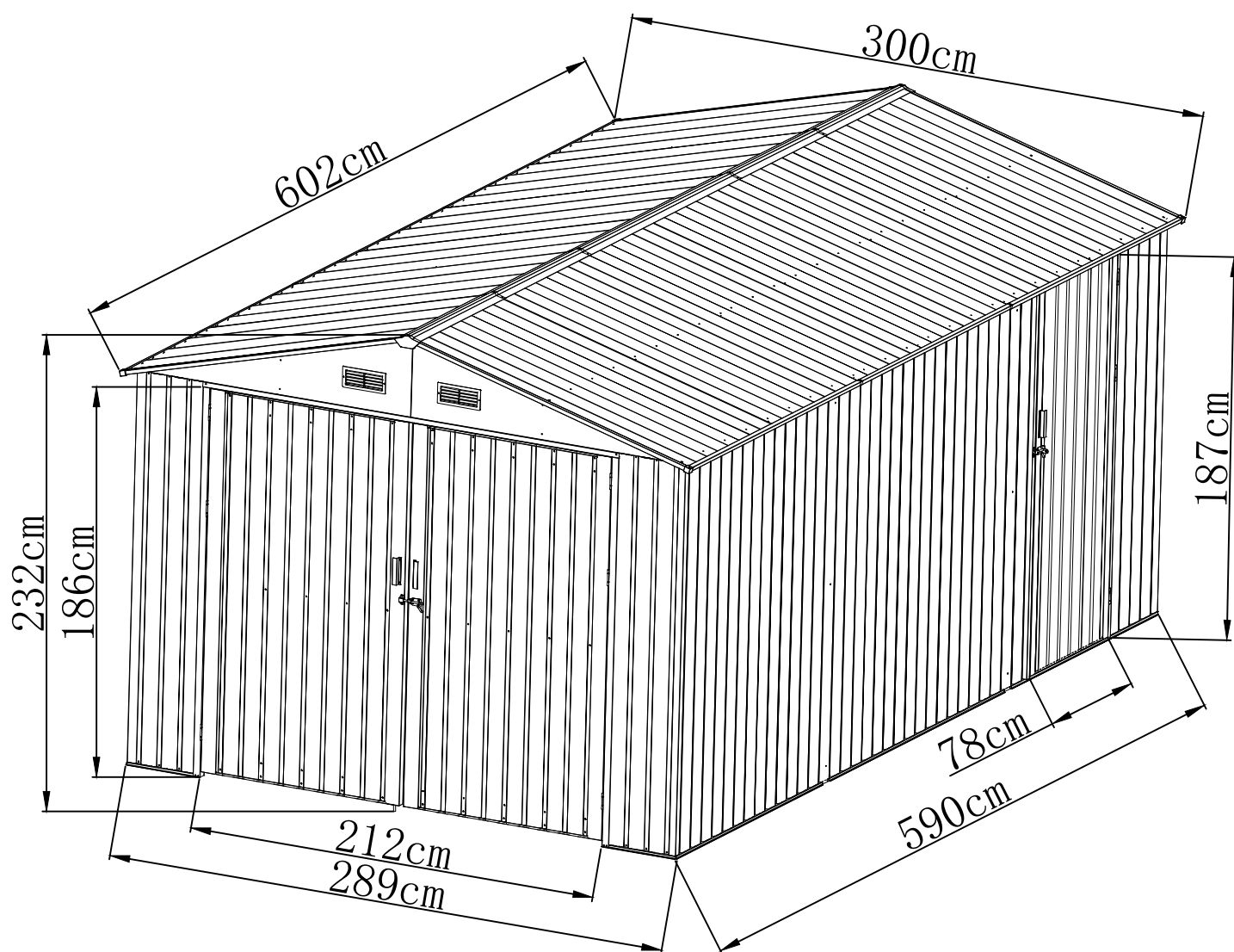

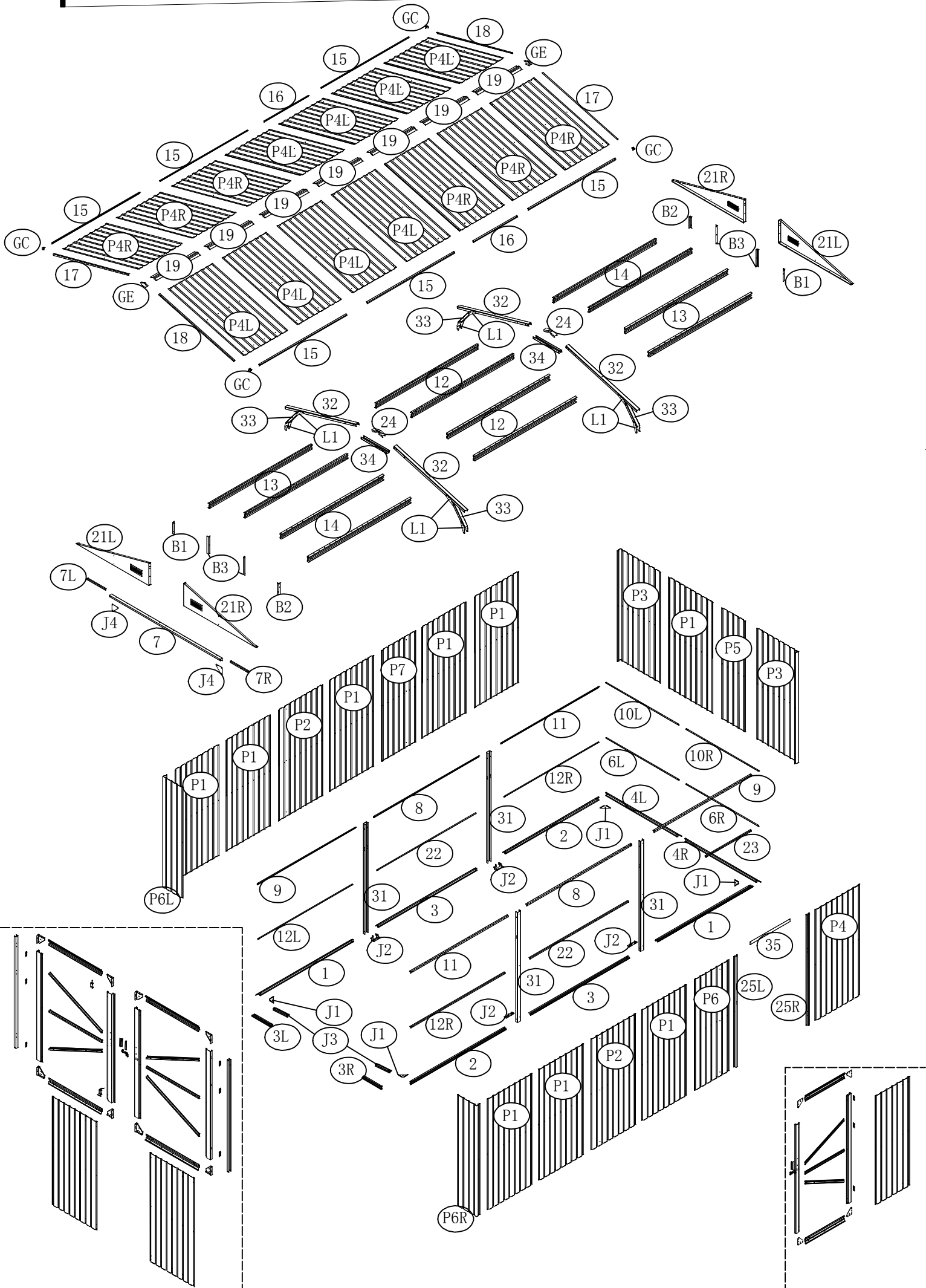

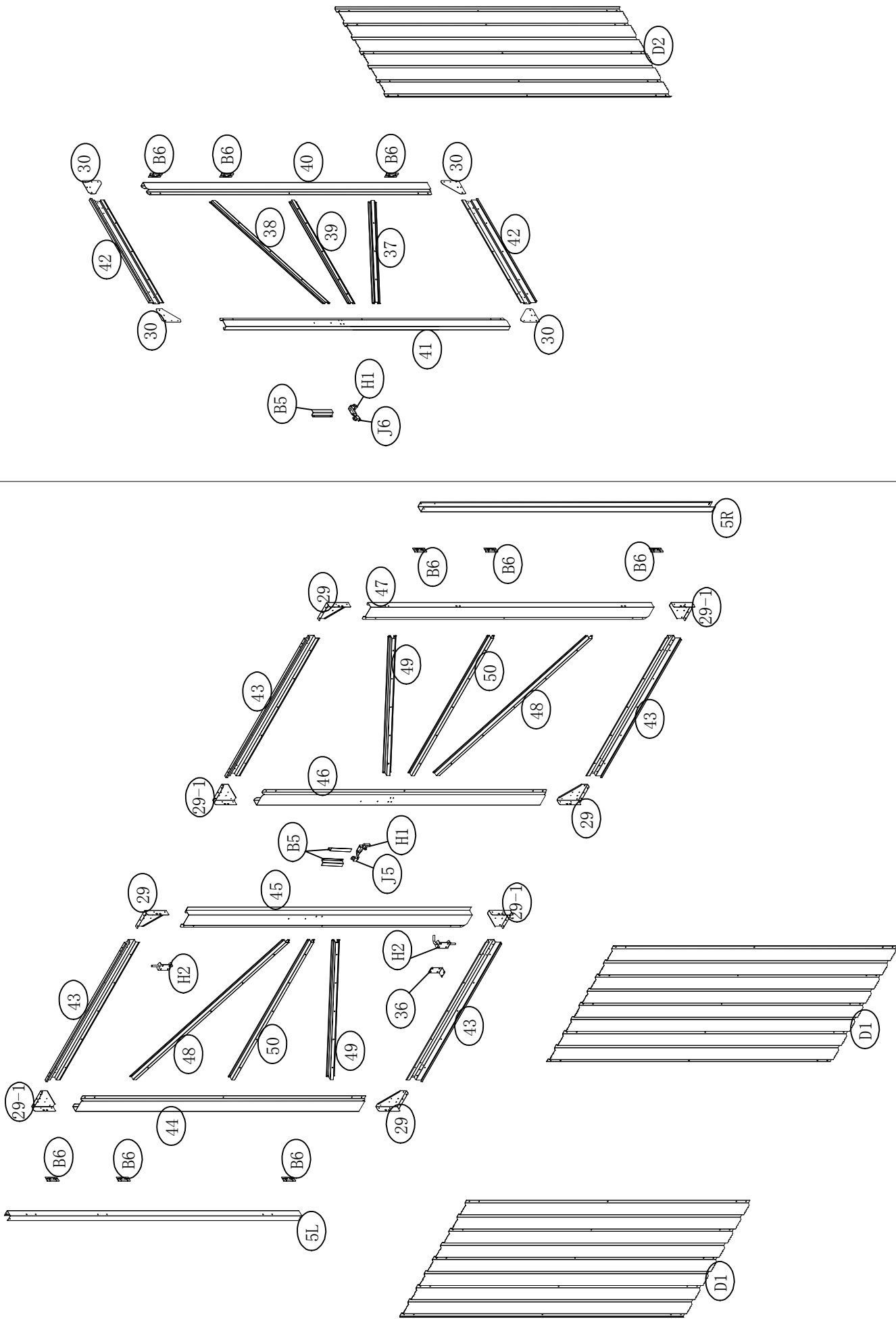



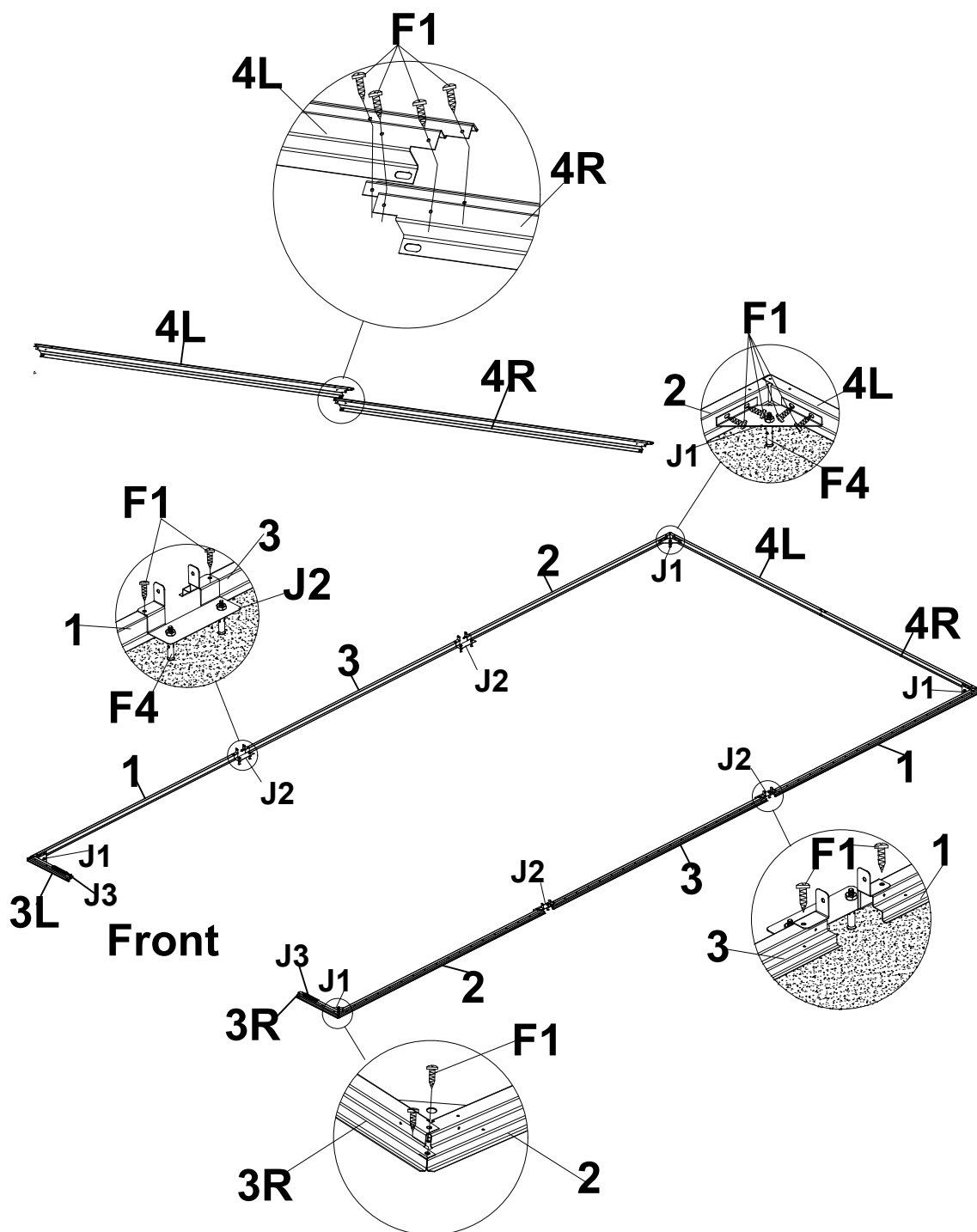



EXAKTA MÅTT





MONTERING AV BOTTENRAMEN



DEL	NR.	ST.
	1	2
	2	2
	3L	1
	3R	1
	4L	1
	4R	1
	3	2
	J1	4
	J2	4
	J3	2
	F1	
	F4	

Se upp för vassa kanter. Använd handskar.

Lägg fram delarna i listan Så som bilden visar och fäst samman dem med skruvarna (F1). Det är viktigt att ramen är rätvinklig.

- * Se till att hålla bottenckenorna rätvinkliga. Det finns extrahål i bottenramen som kan användas för att förankra plåtgaraget i en grund av virke eller gjuten betongbeläggning. Av säkerhetsskäl rekommenderar vi att du väljer ur vårt förankringsutbud.

MONTERING AV SIDOVÄGGAR

Obs! Håll ett avstånd på 7–8 cm mellan varje förstärkt skenas vänstra och högra sida, se ritningen

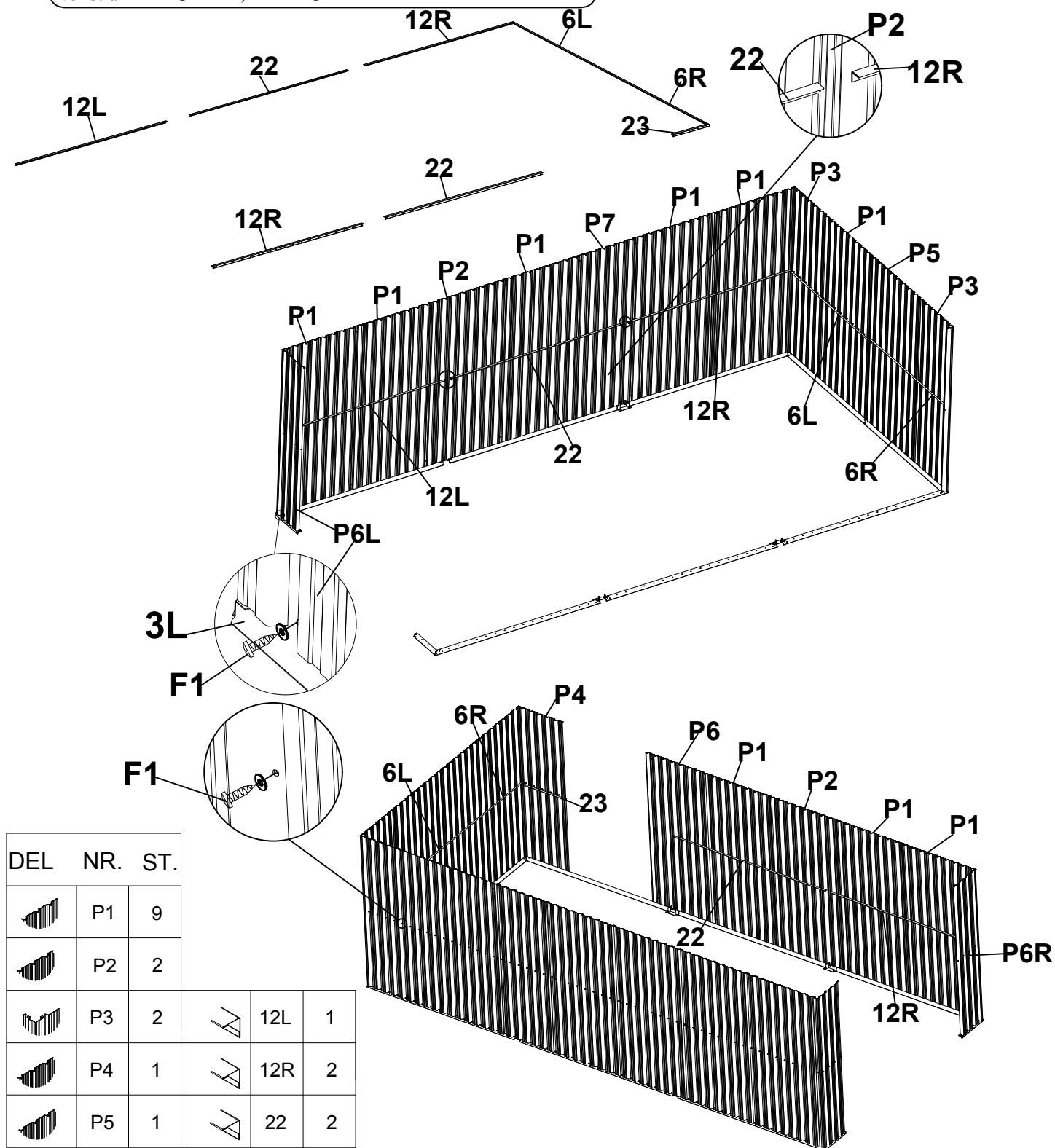





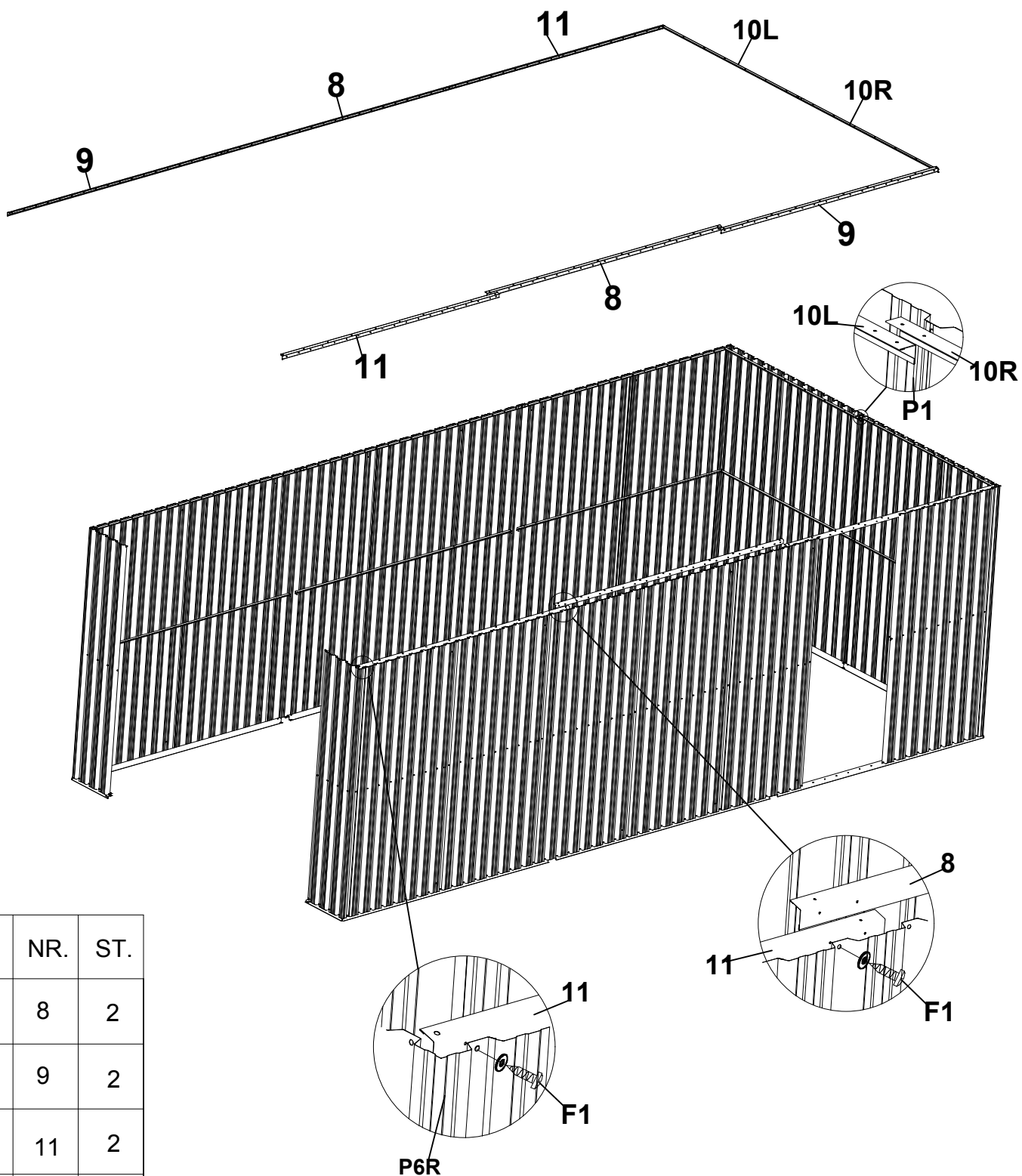

DEL	NR.	ST.				
	P1	9				
	P2	2				
	P3	2		12L	1	
	P4	1		12R	2	
	P5	1		22	2	
	P6	1		23	1	
	P7	1		6L	1	
	P6L	1		6R	1	
	P6R	1		F1		

Varning! UTFÖR INTE DETTA STEG OM DET BLÅSER!

Leta fram delarna i listan. Placera panelerna på bottenramen, en efter en, fäst samtidigt väggskenorna mitt på väggen för att undvika att väggen rasar samman.

MONTERING AV TOPPRAMEN







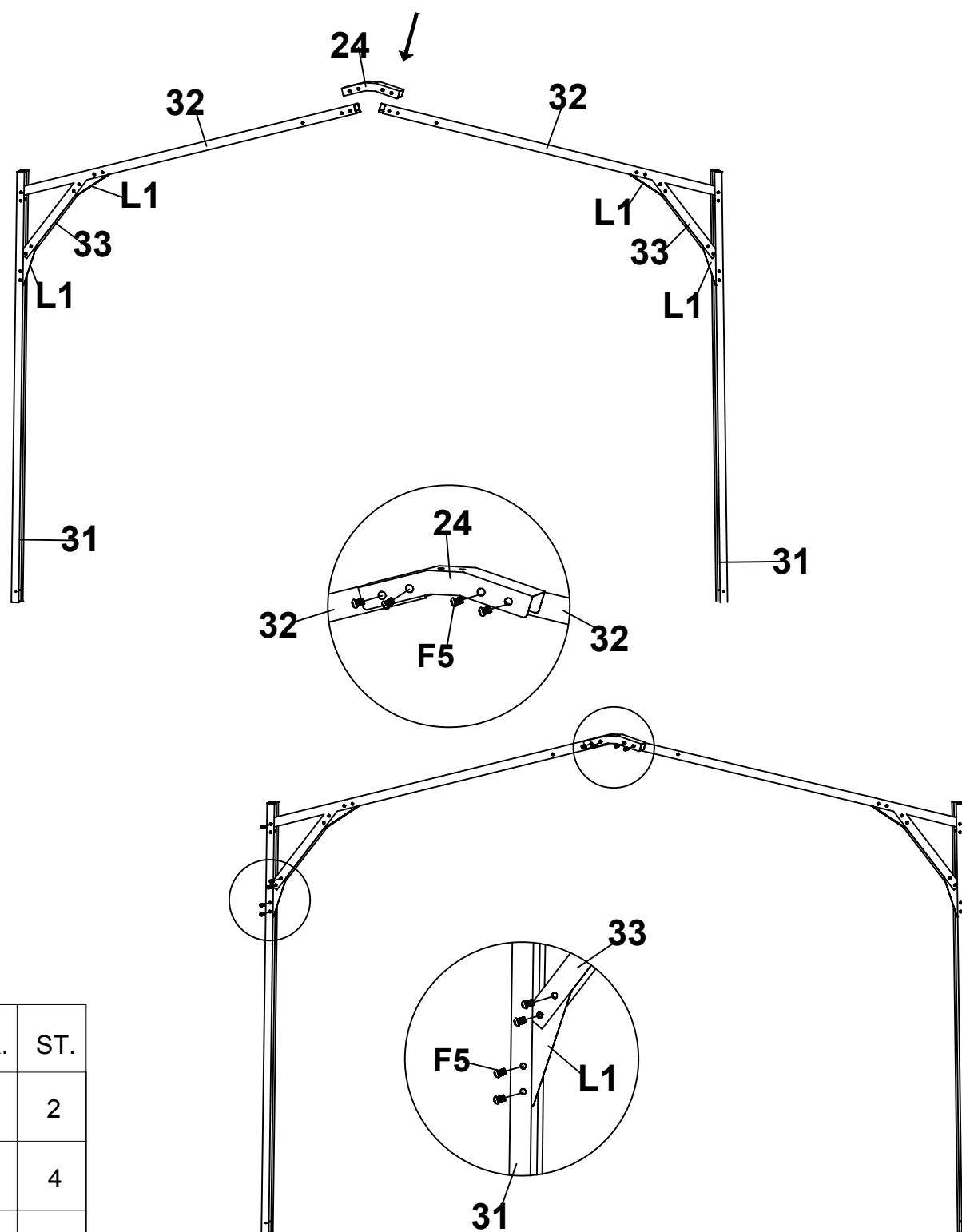

DEL	NR.	ST.
	8	2
	9	2
	11	2
	10L	1
	10R	1
	F1	

Lägg ut respektive takskena som bilden visar och fäst med skruvar och brickor (F1).

MONTERING AV STÖDKONSTRUKTION-1



DEL	NR.	ST.
	24	2
	31	4
	32	4
	33	4
	L1	16
	F5	

Leta fram alla delar i listan, länka samman en och en enligt bilden, fäst med F5.
Observera att 2 uppsättningar stödkonstruktioner ska monteras.

MONTERING AV STÖDKONSTRUKTION-2

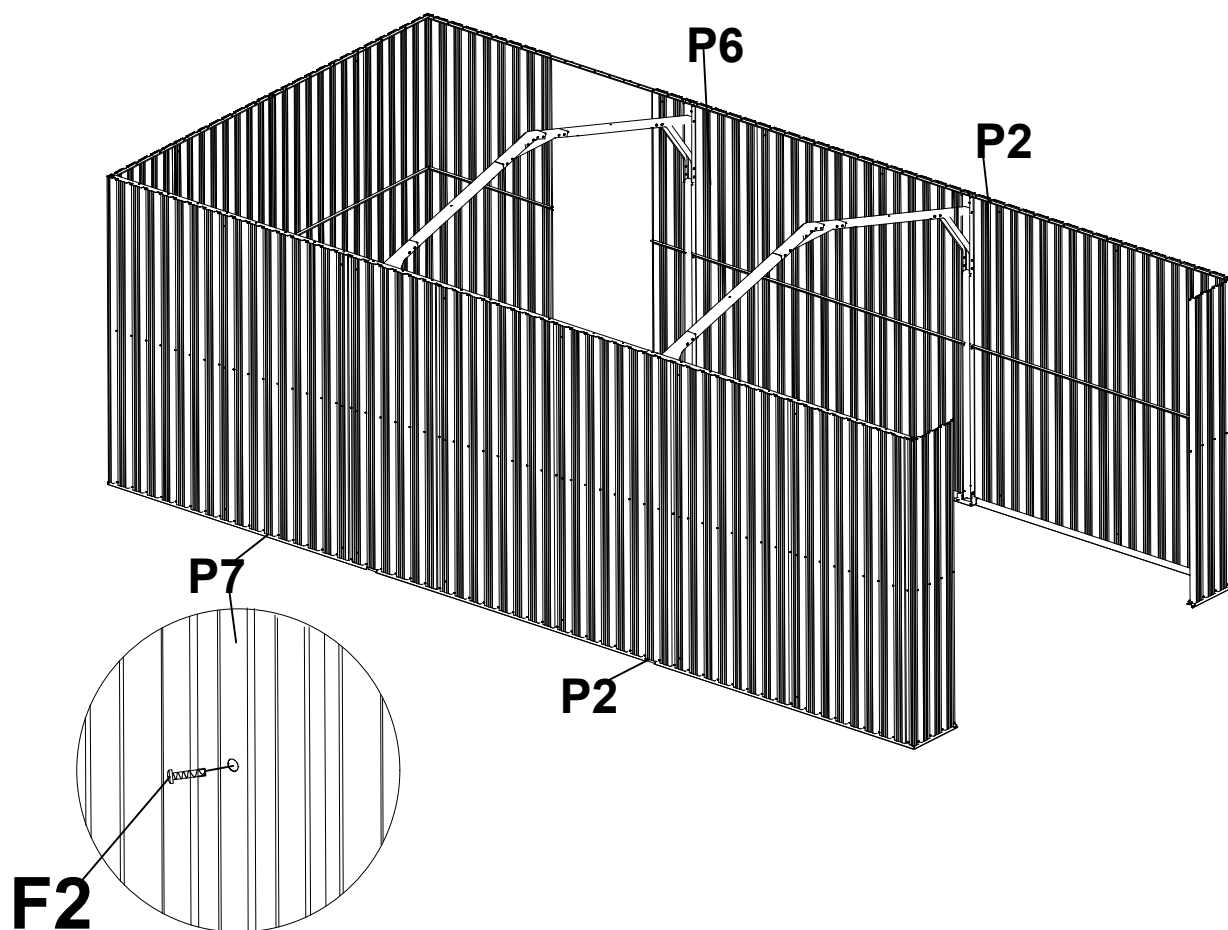

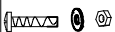
DEL	NR.	Antal
	F2	

Placera stödkonstruktionen korrekt (se avståndet på 7–8 cm som nämns under monteringen av väggnanelerna). Fixera sen stödkonstruktionerna mot panelerna med skruv (F2).

MONTERING AV PORTRAMEN

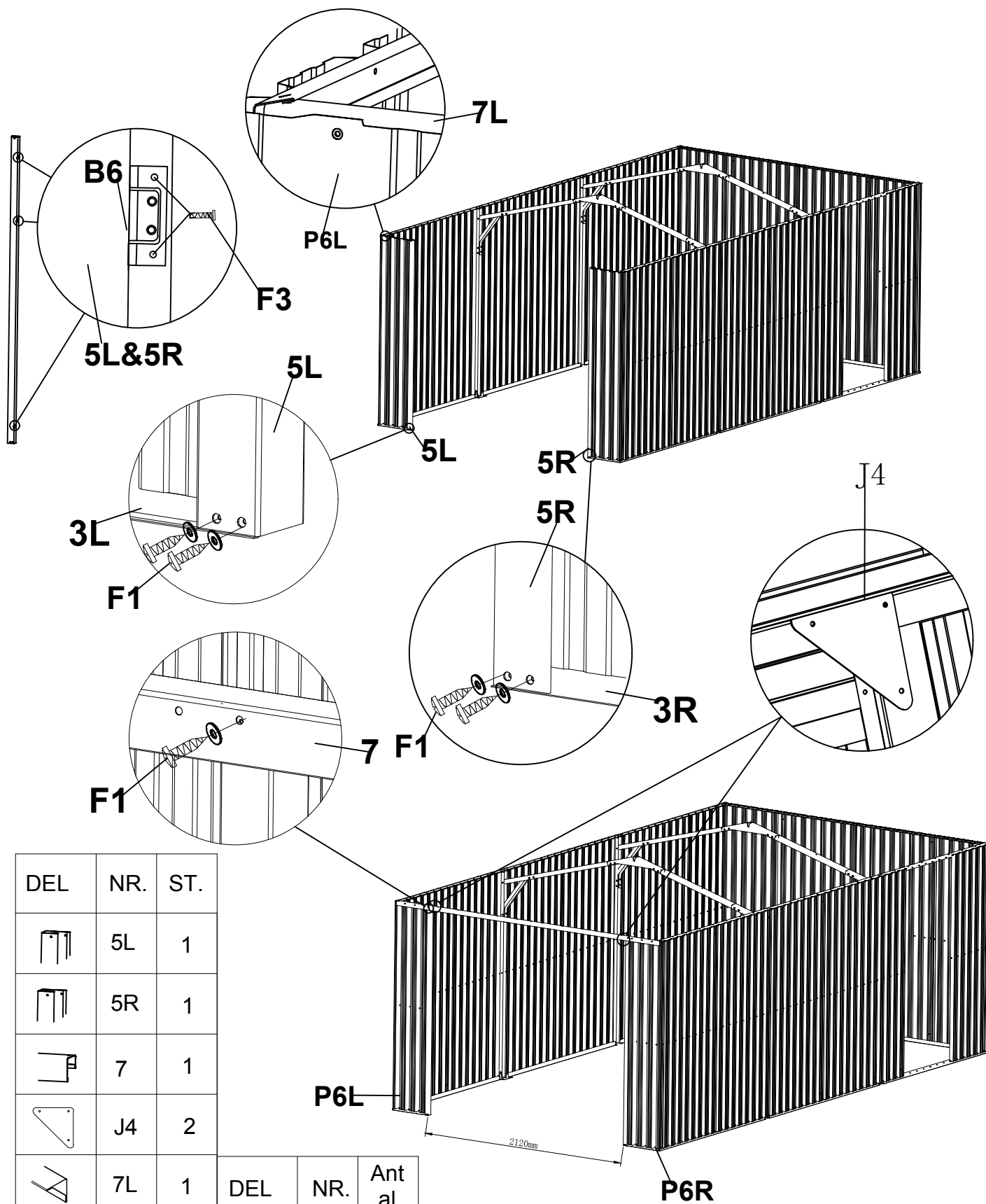

DEL	NR.	ST.
	5L	1
	5R	1
	7	1
	J4	2

DEL	NR.	Antal
	7L	1
	7R	1
	B6	6
	F1	
	F3	

MONTERING AV GAVLARNA

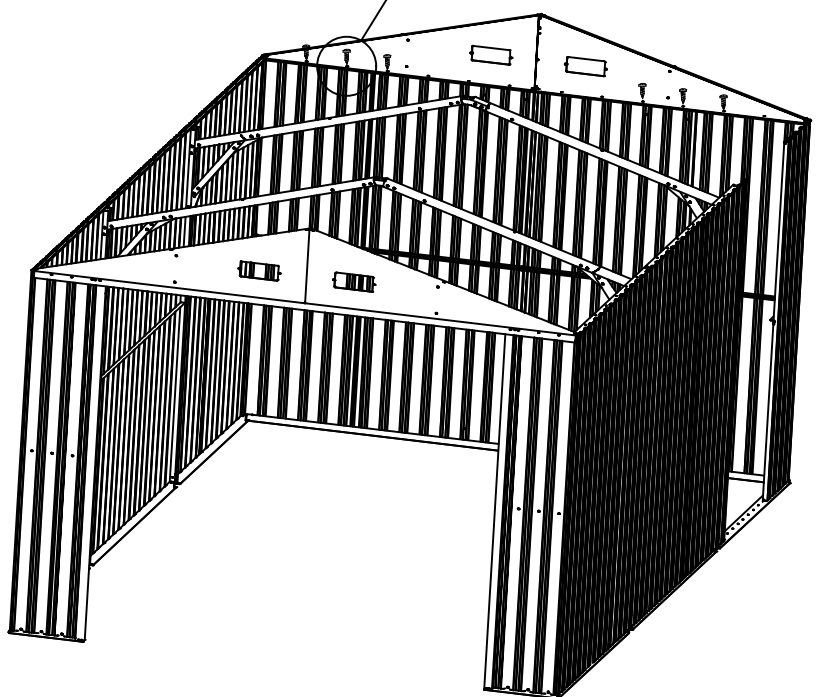
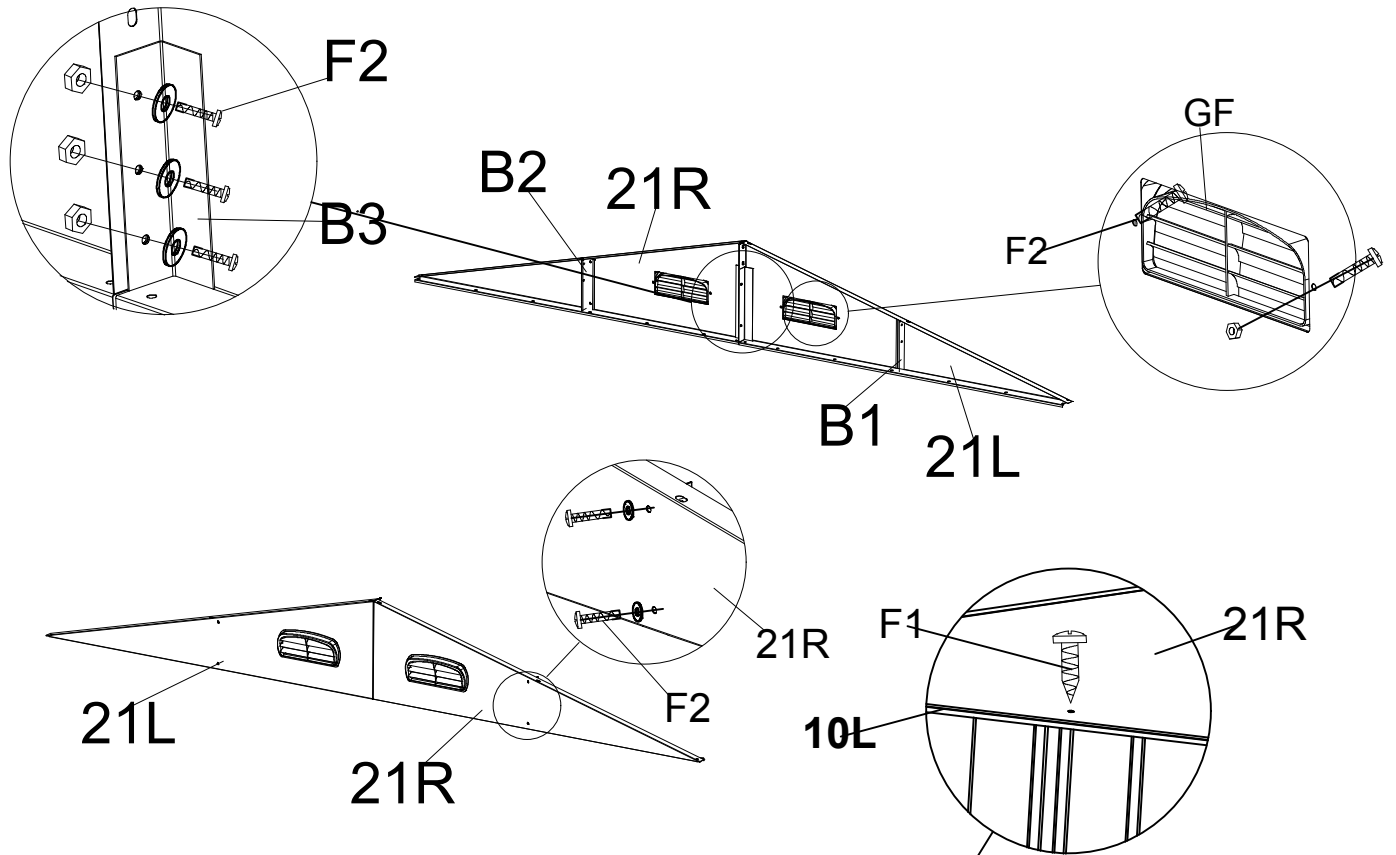

Obs! Skruv i alla hål

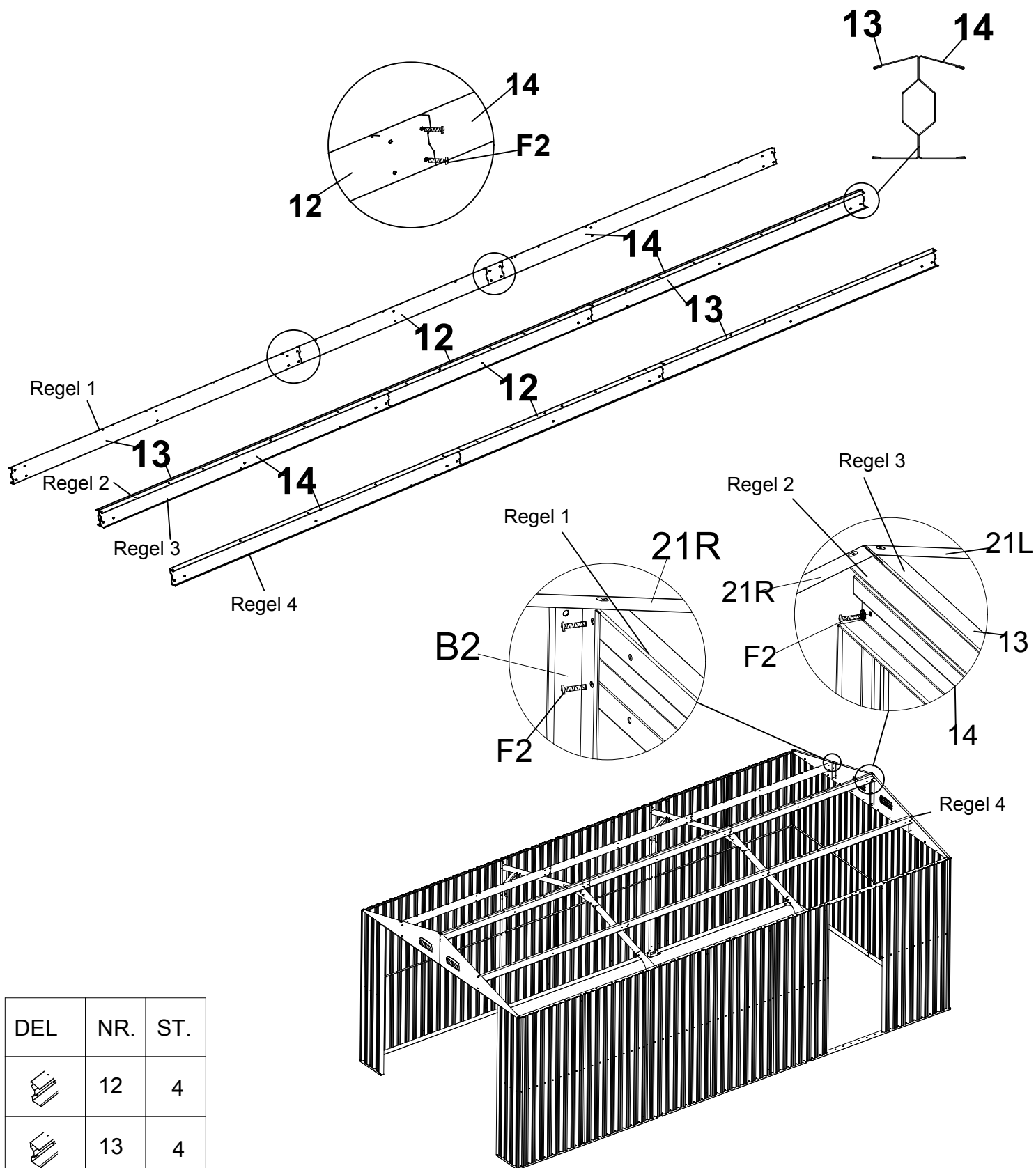

DEL	NR.	ST.
	21L	2
	21R	2
	B1	2
	B2	2
	B3	4
	GF	4
	F1	
	F2	

MONTERING AV TAKREGLARNA

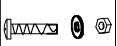

DEL	NR.	ST.
	12	4
	13	4
	14	4
	F2	

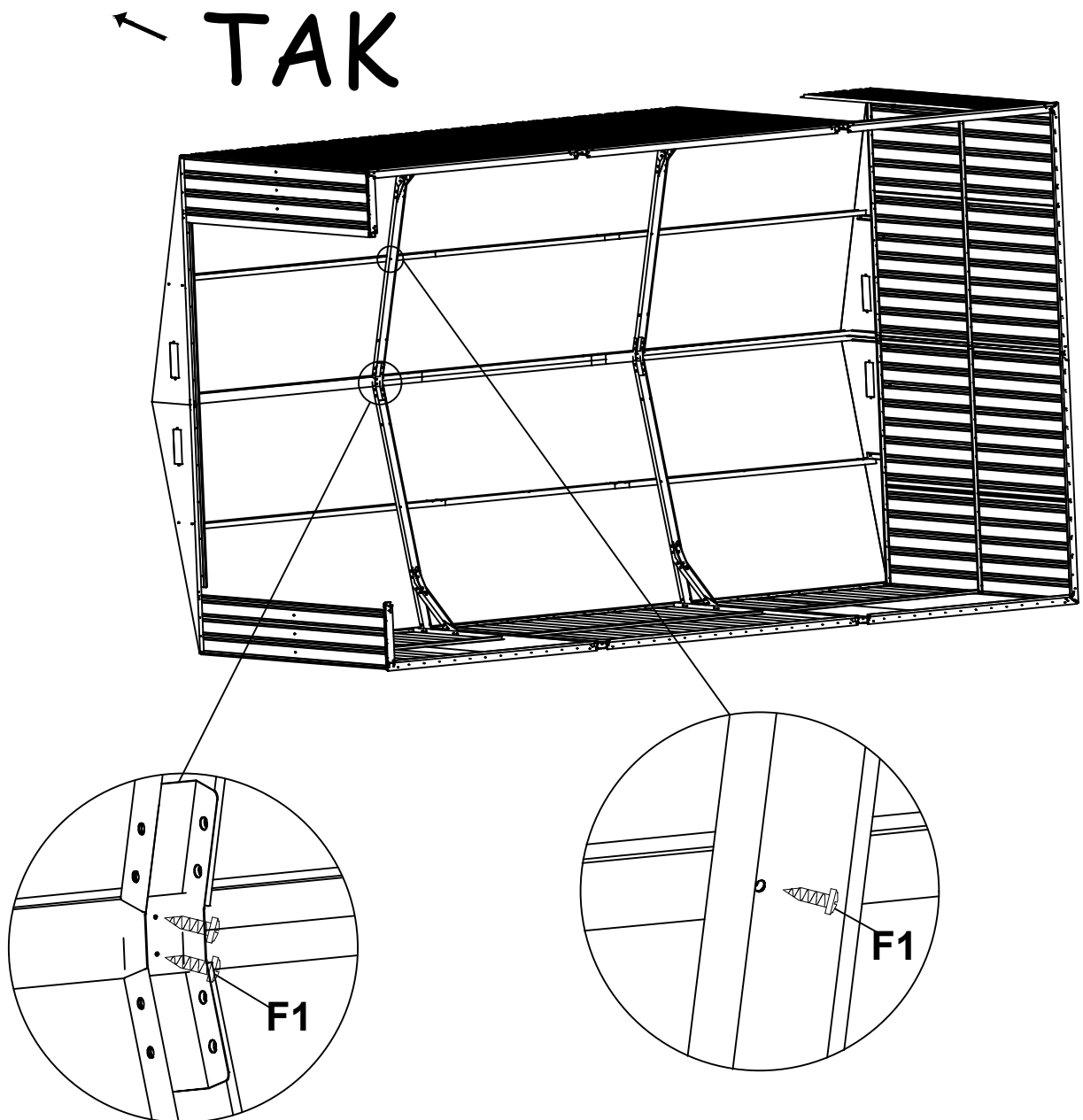

FÖRSTÄRKNING AV TAKREGELN-1

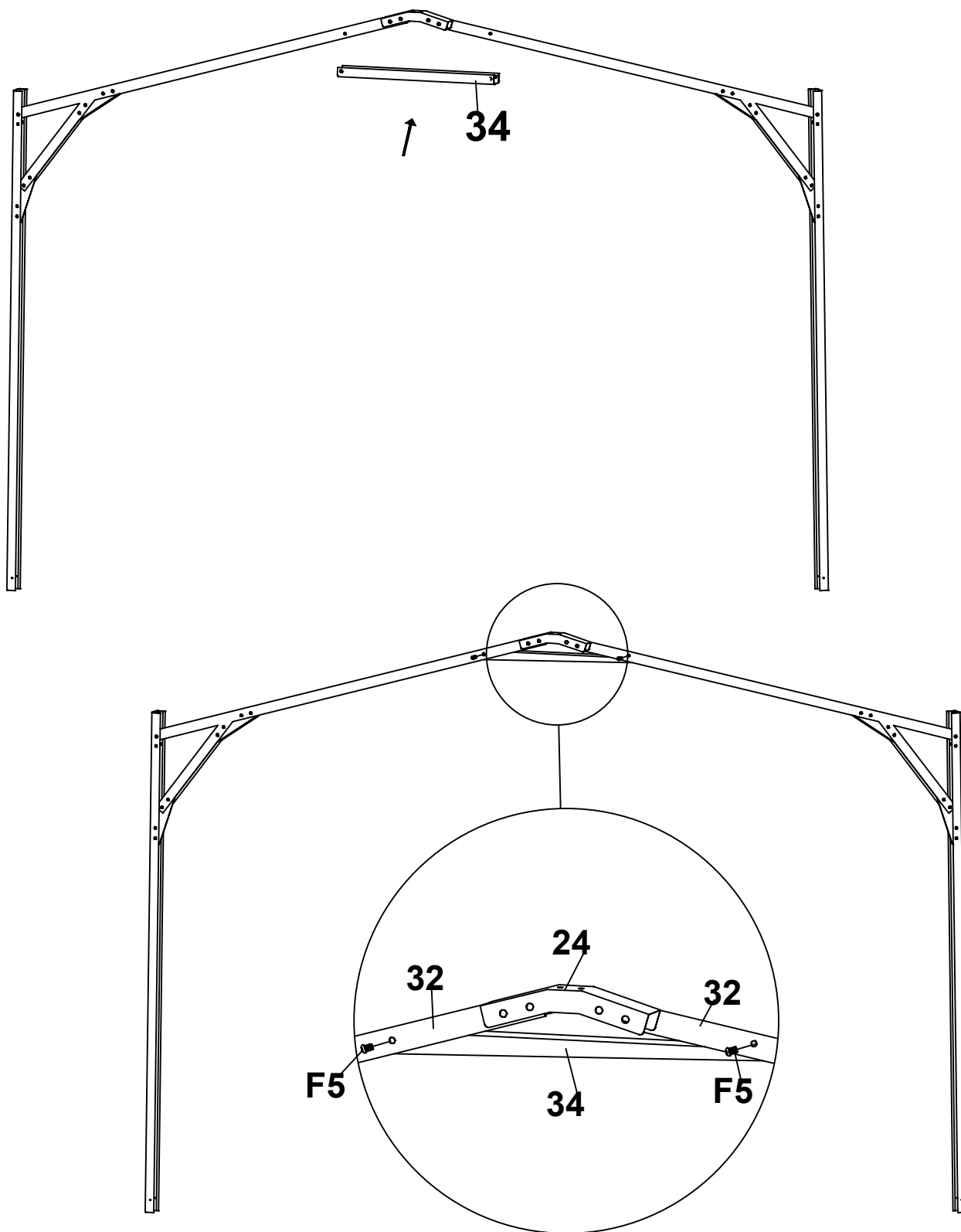

DEL	NR.	Antal
	F1	

FÖRSTÄRKNING AV TAKREGELN-2





DEL	NR.	Antal
	34	2
	F5	

MONTERING AV TAKPLÅTARNA

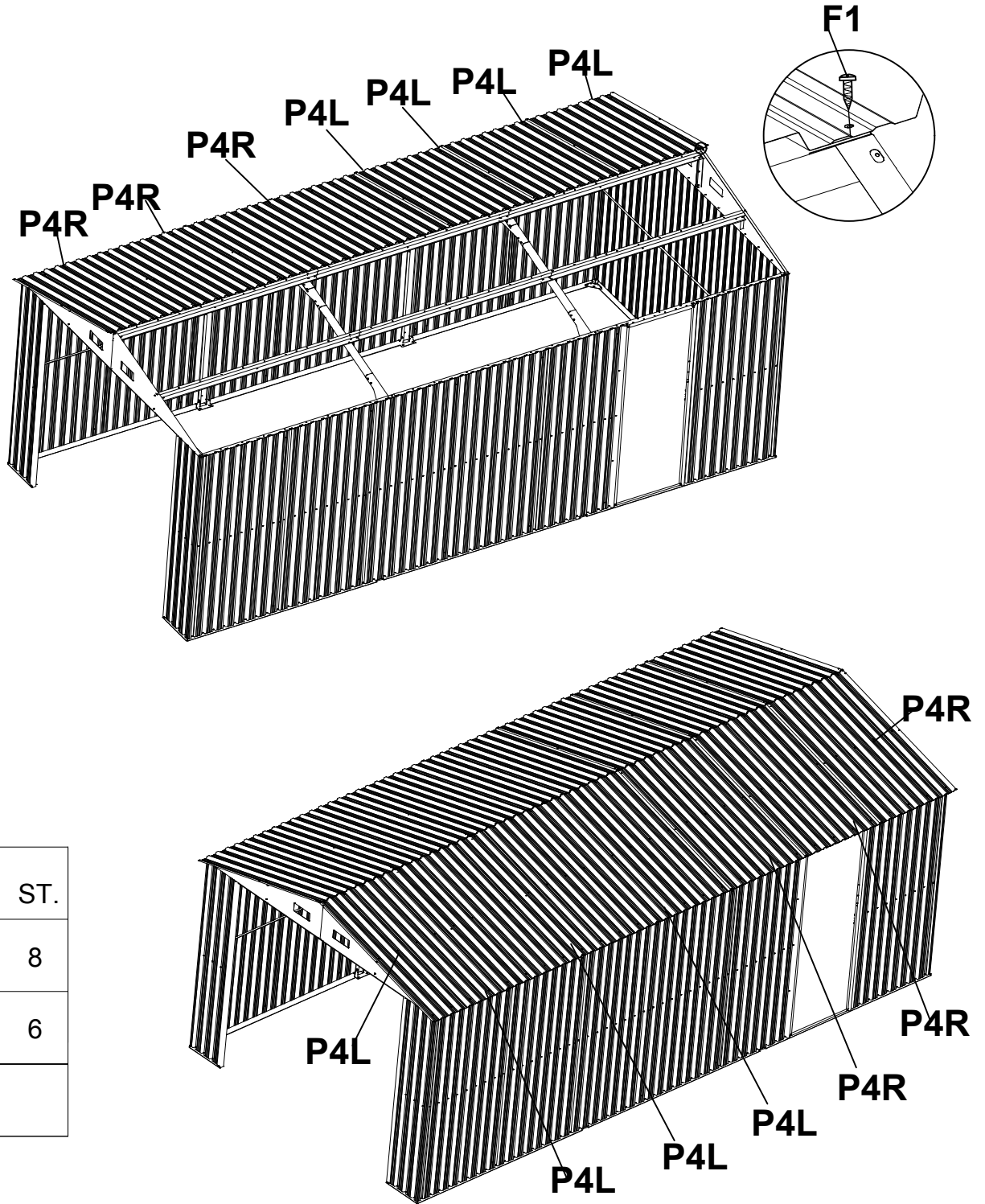
Obs! Skruvar i alla hål i plåtarna.







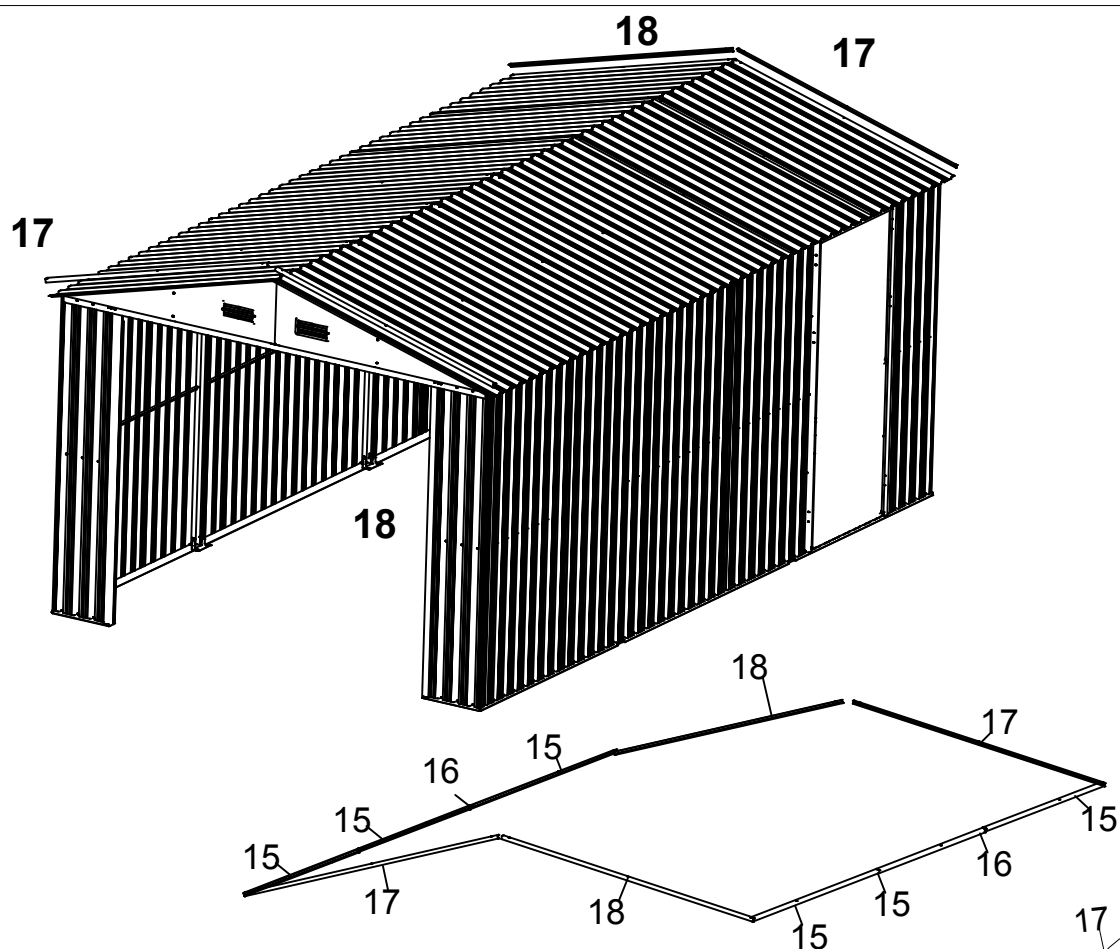

DEL	NR.	ST.
	P4L	8
	P4R	6
	F1	

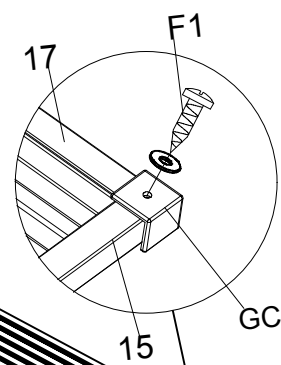
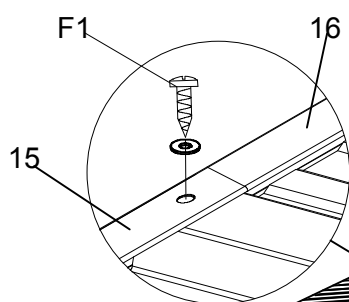
MONTERING AV TAKLISTERNA







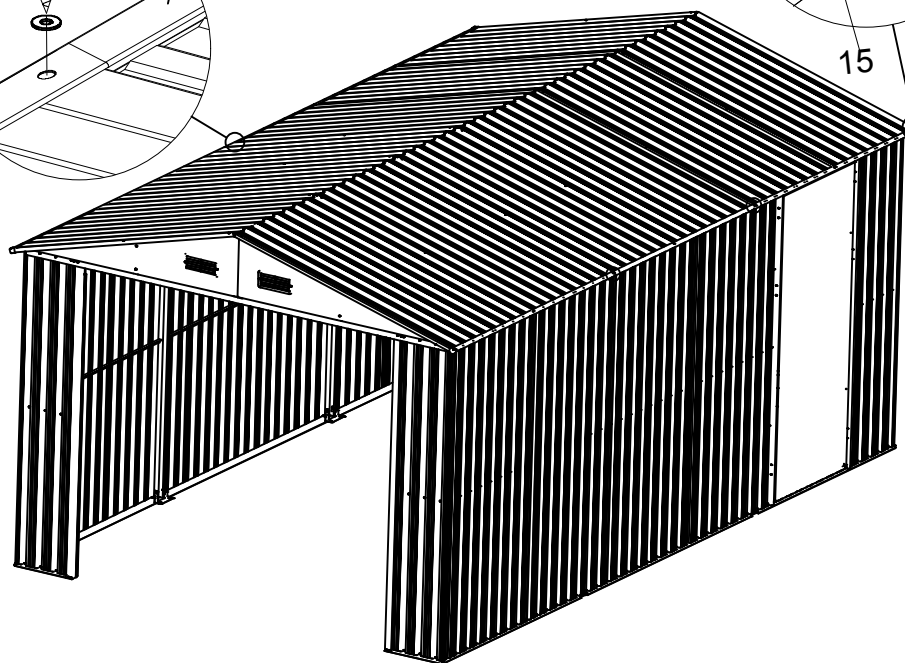

Obs! Skruv i alla hål å takskenorna.

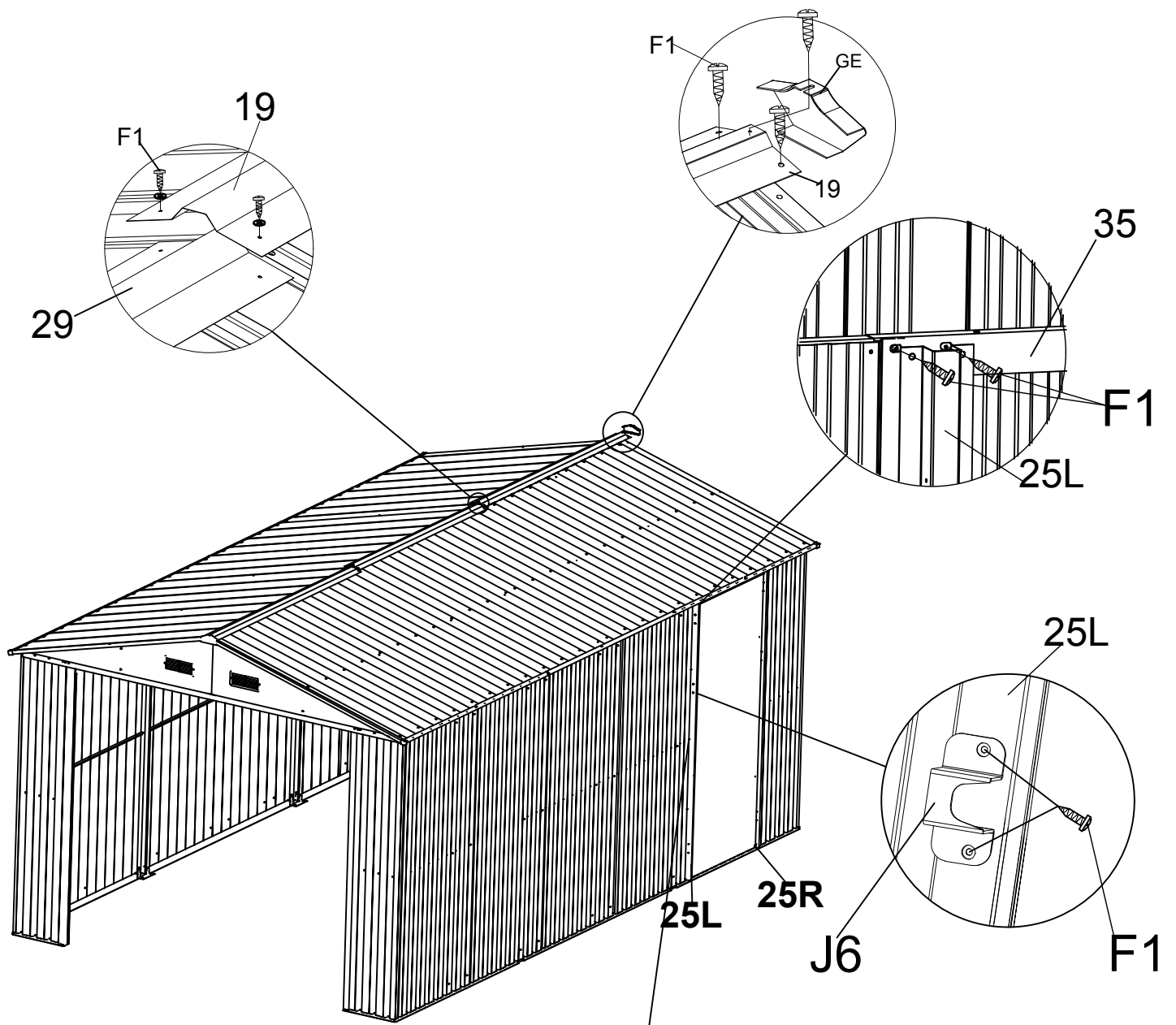



DEL	NR.	ST.
	15	6
	16	2
	17	2
	18	2
	GC	4
	F1	









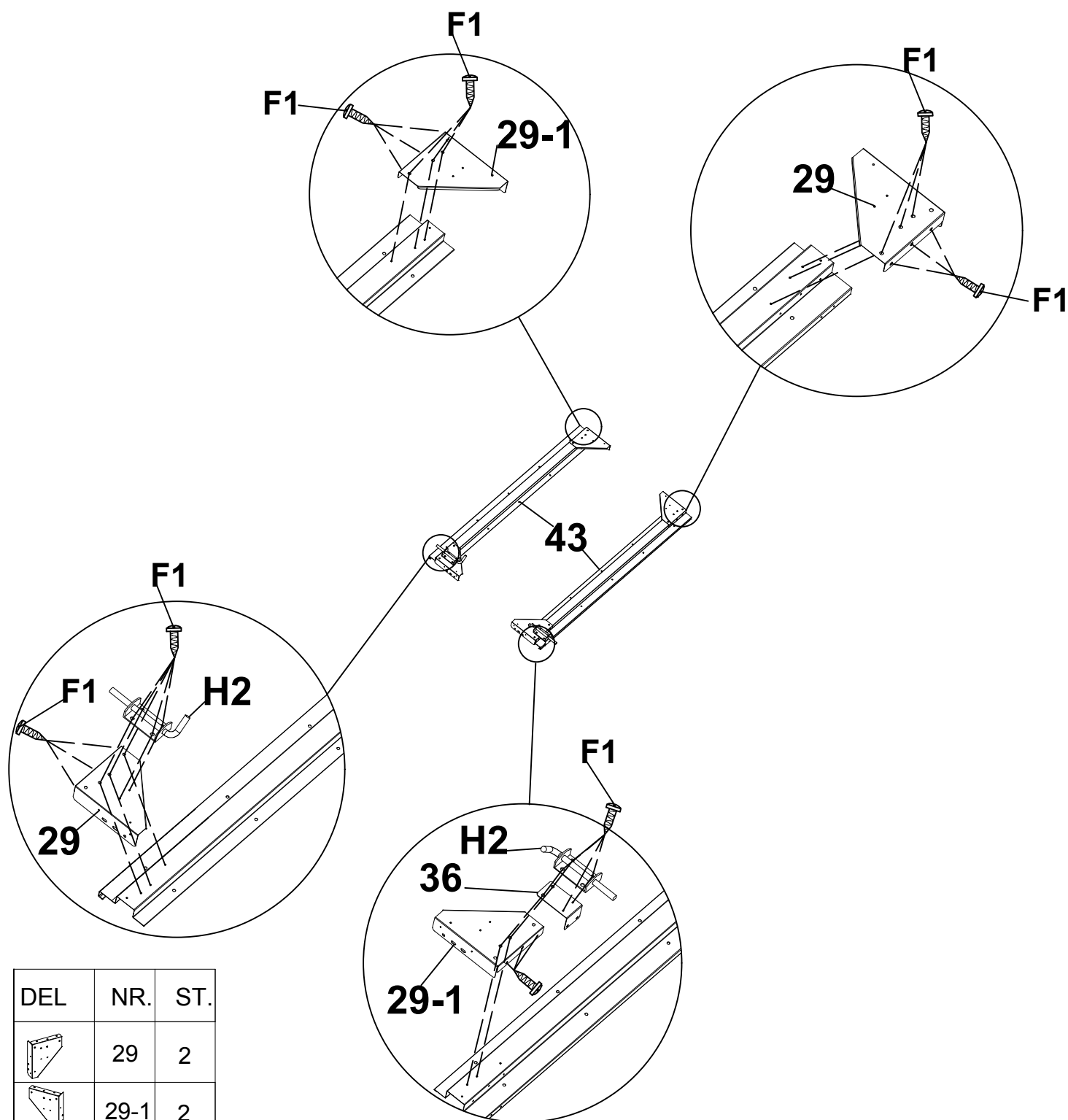

DEL	NR.	ST.
	19	7
	GE	2
	F1	
	25L	1
	25R	1

DEL	NR.	ST.
	F2	1
	J6	1
	35	1





MONTERING AV PORTAR/DÖRR-1

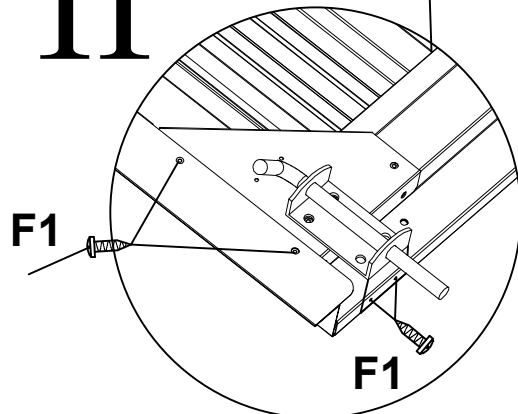
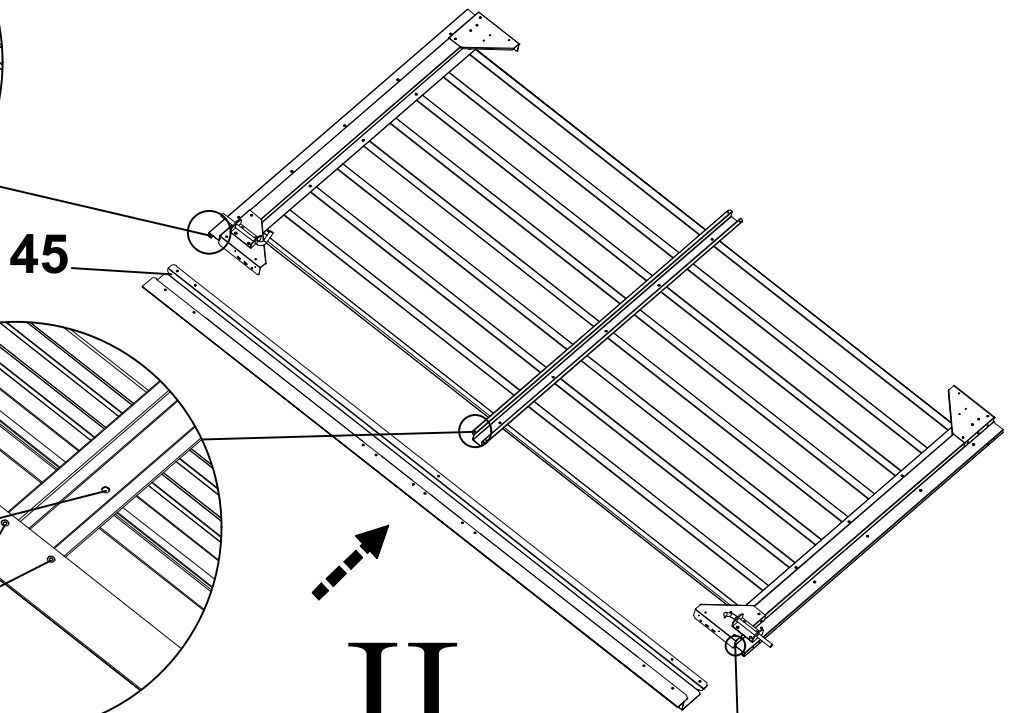
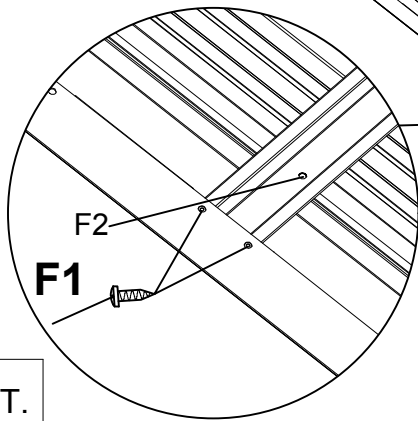
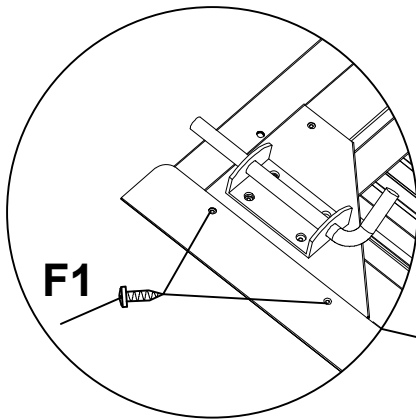
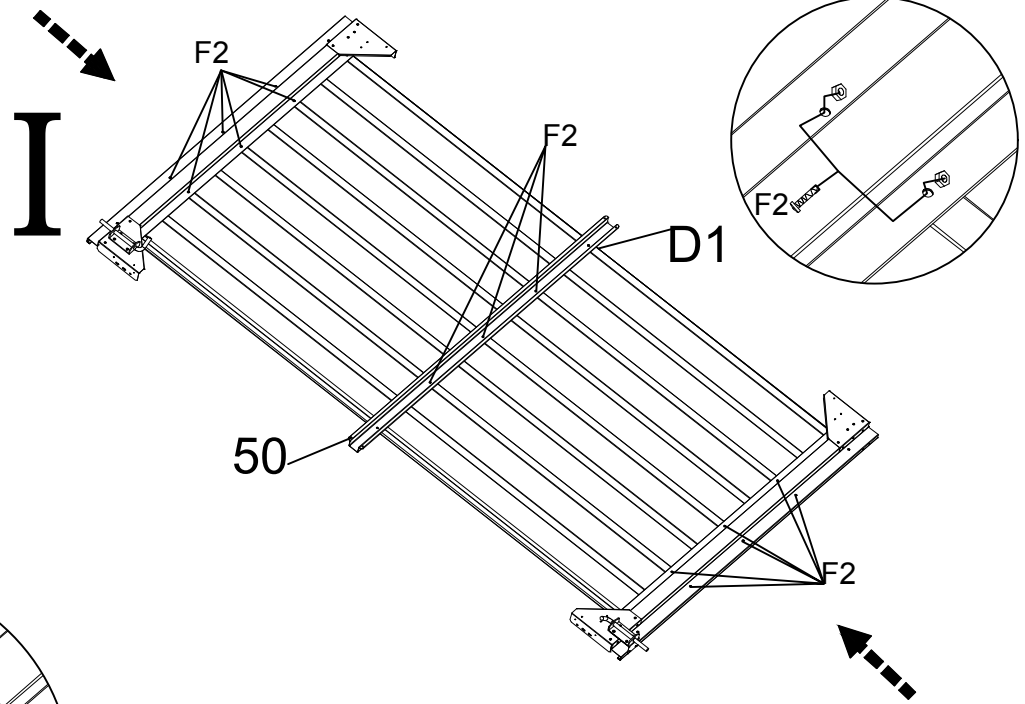

DEL	NR.	ST.
	29	2
	29-1	2
	43	2
	H2	2
	36	1
	F1	

MONTERING AV PORTAR/DÖRR-2





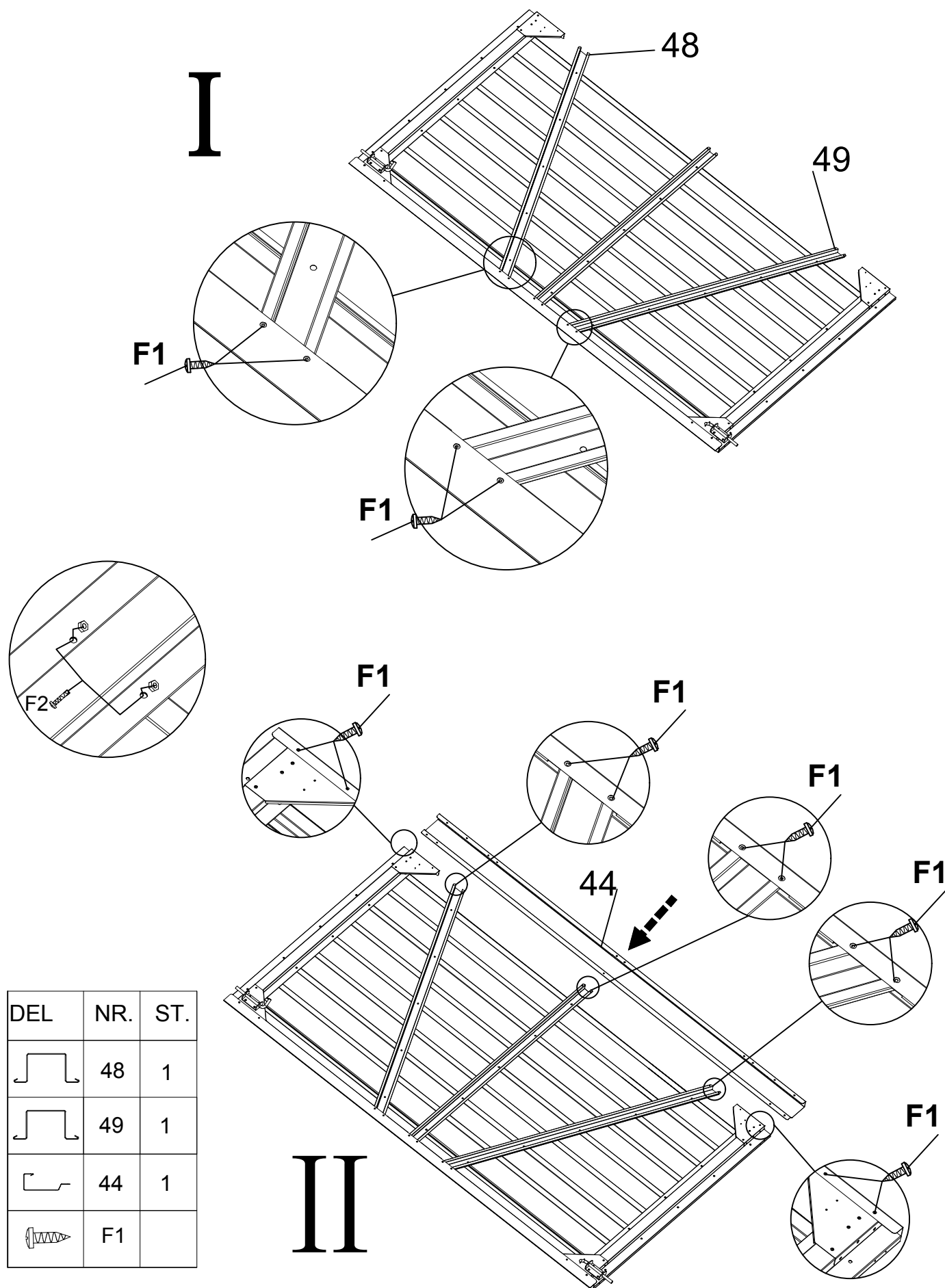

DEL	NR.	ST.
	45	1
	50	1
	D1	1
	F2	
	F1	

MONTERING AV PORTAR/DÖRR-3

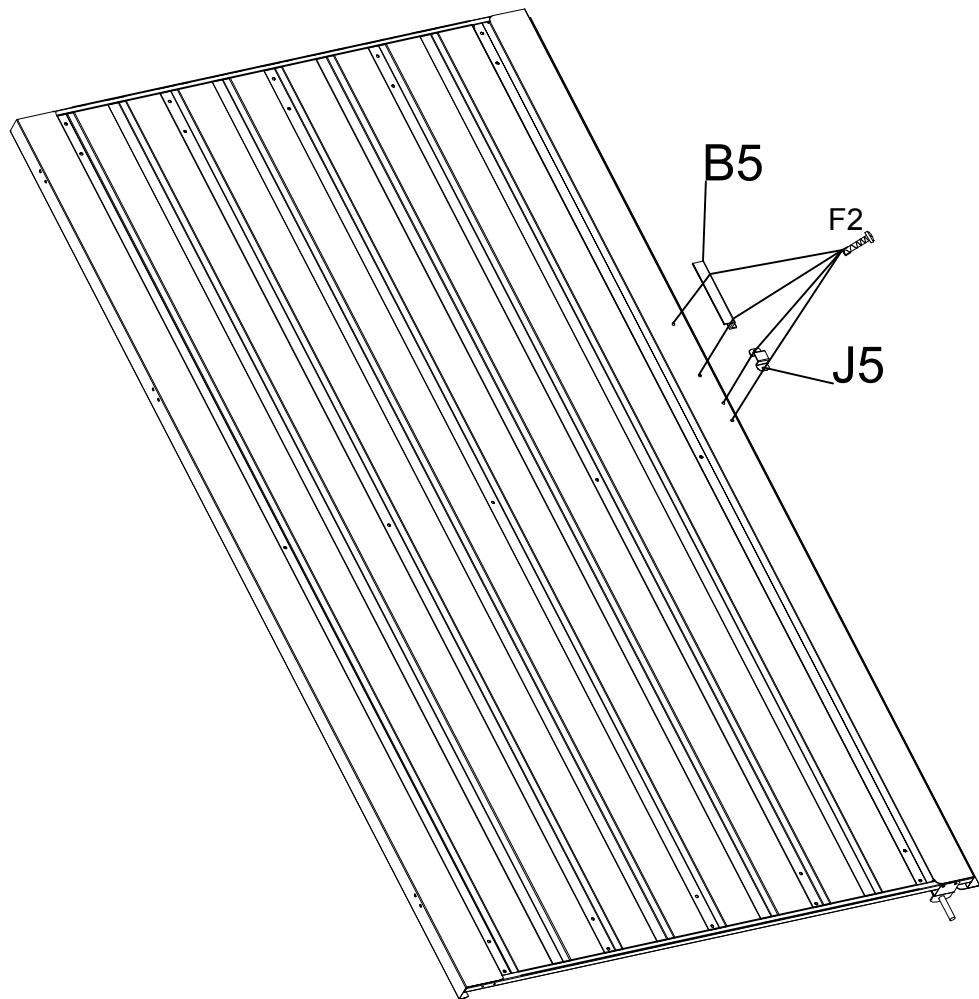
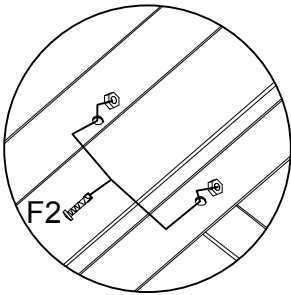



MONTERING AV PORTAR/DÖRR-4

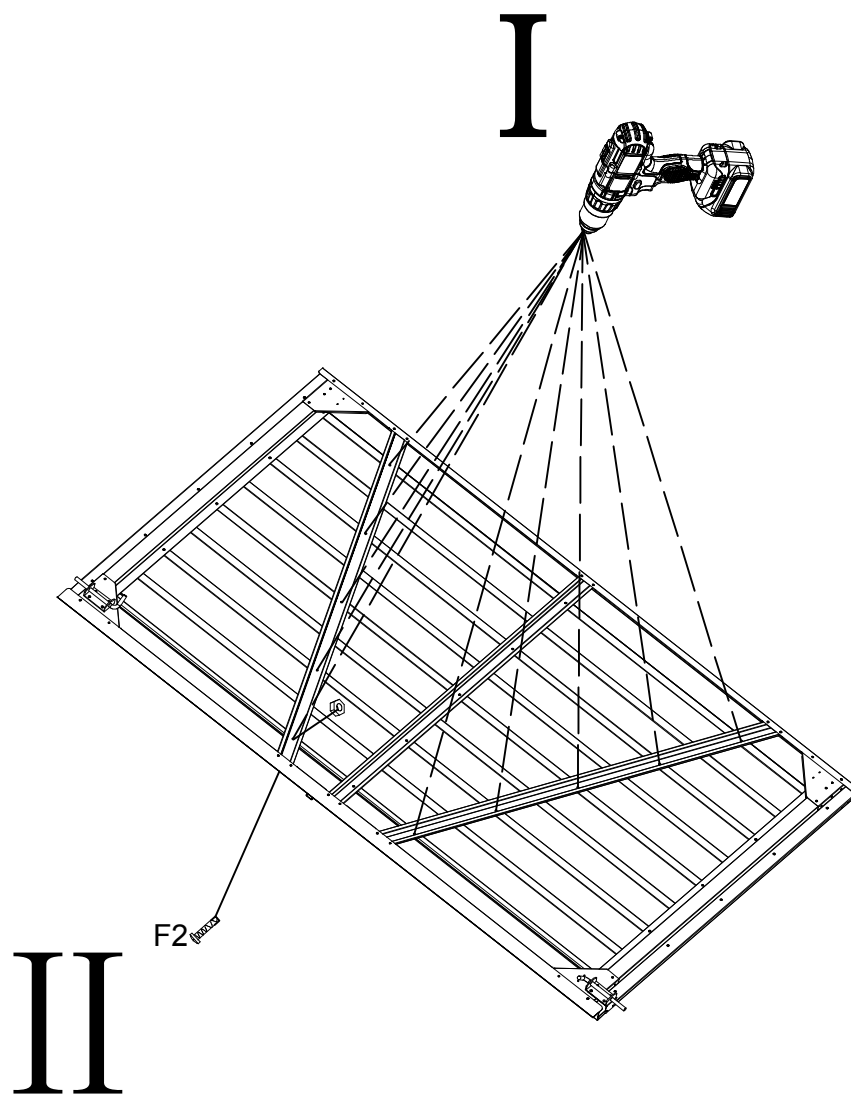

DEL	NR.	ST.
	B5	1
	J5	1
	F2	

MONTERING AV PORTAR/DÖRR-5



DEL	NR.	ST.
	F2	
		



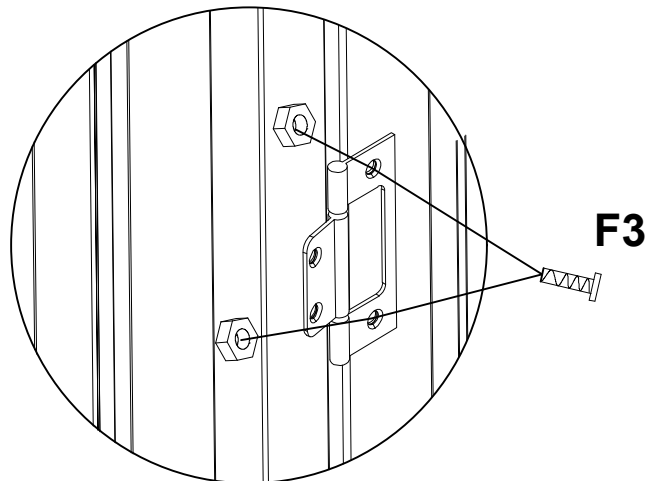
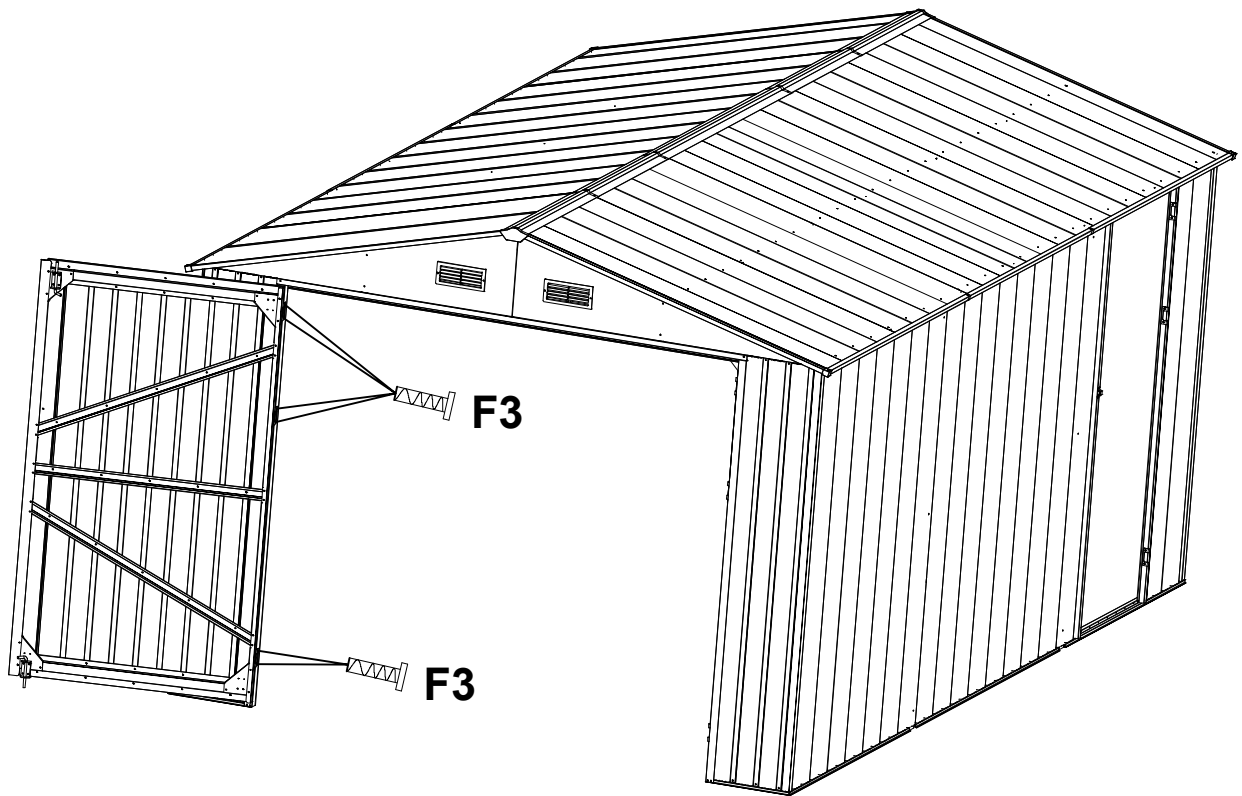

MONTERING AV PORTAR/DÖRR-6

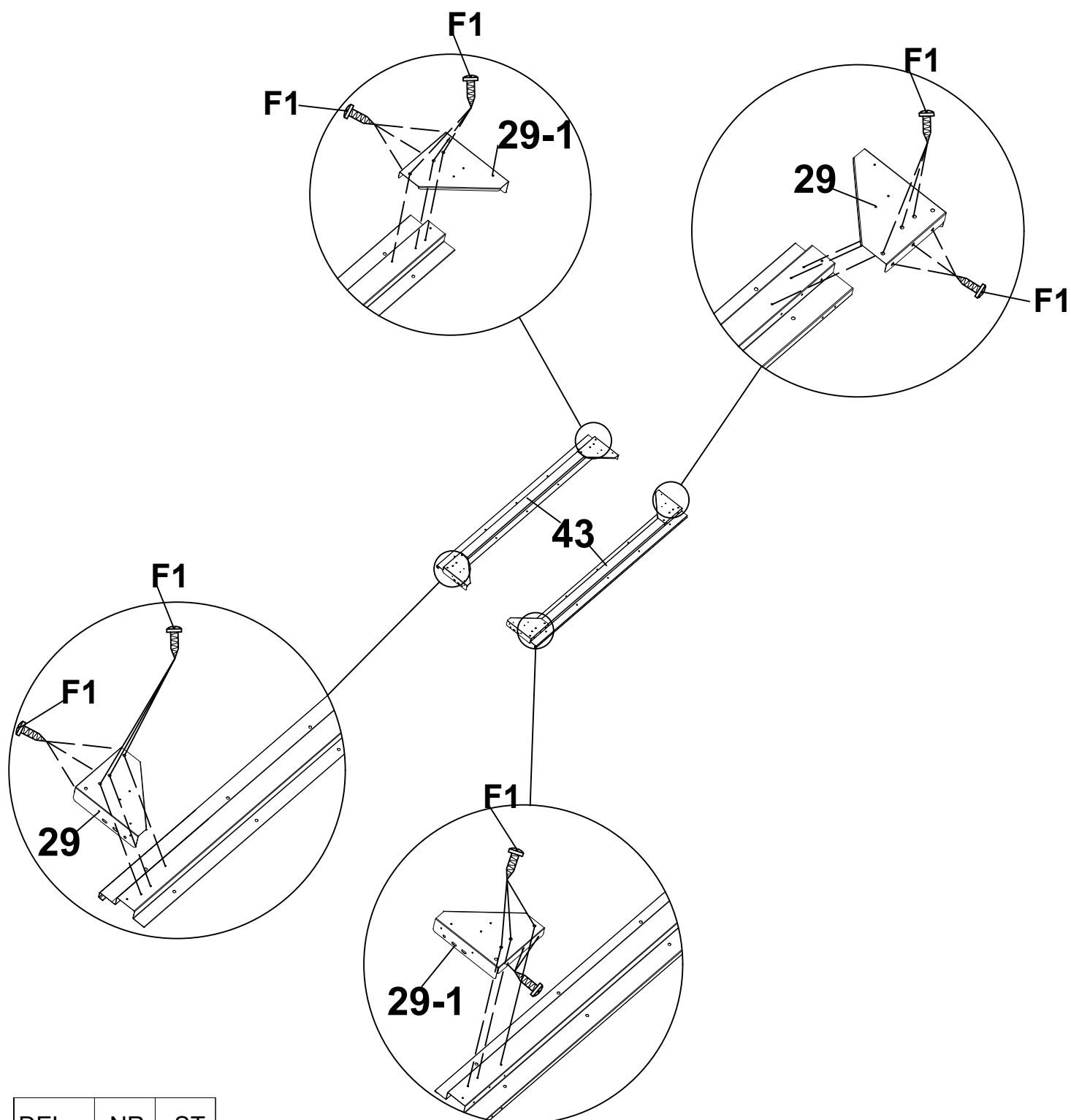

DEL	NR.	ST.
 	F3	

MONTERING AV PORTAR/DÖRR-7



DEL	NR.	ST.
	29	2
	29-1	2
	43	2
	F1	

MONTERING AV PORTAR/DÖRR-8

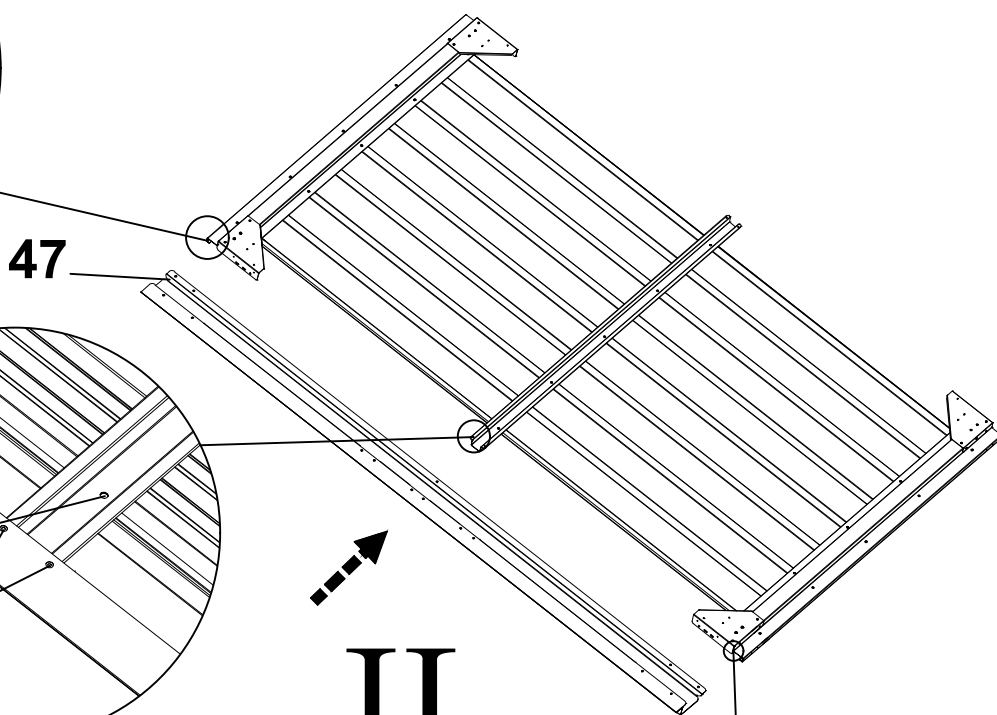
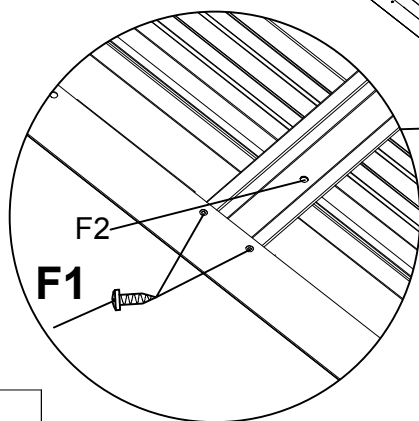
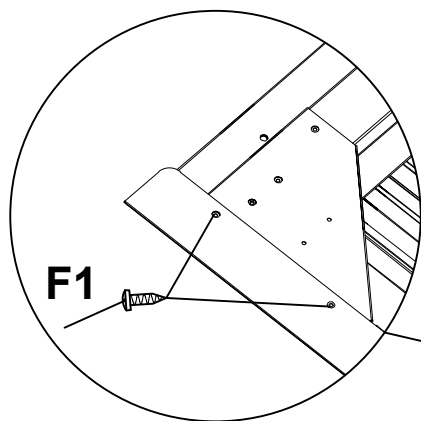
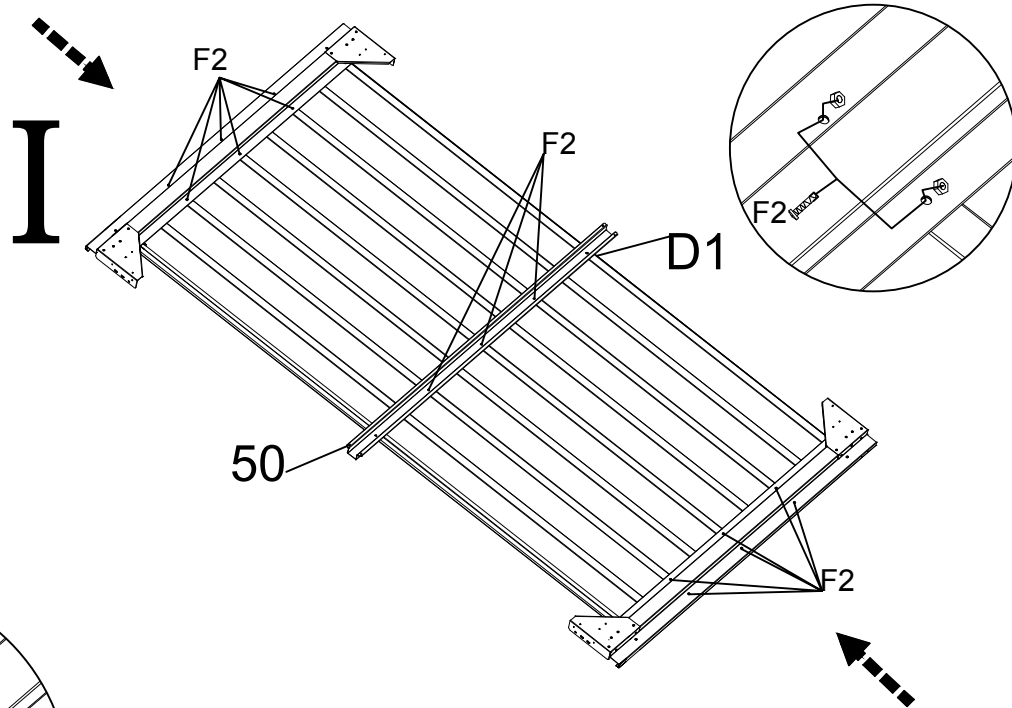

II

DEL	NR.	ST.
	47	1
	50	1
	D1	1
	F2	
	F1	

MONTERING AV PORTAR/DÖRR-9

I

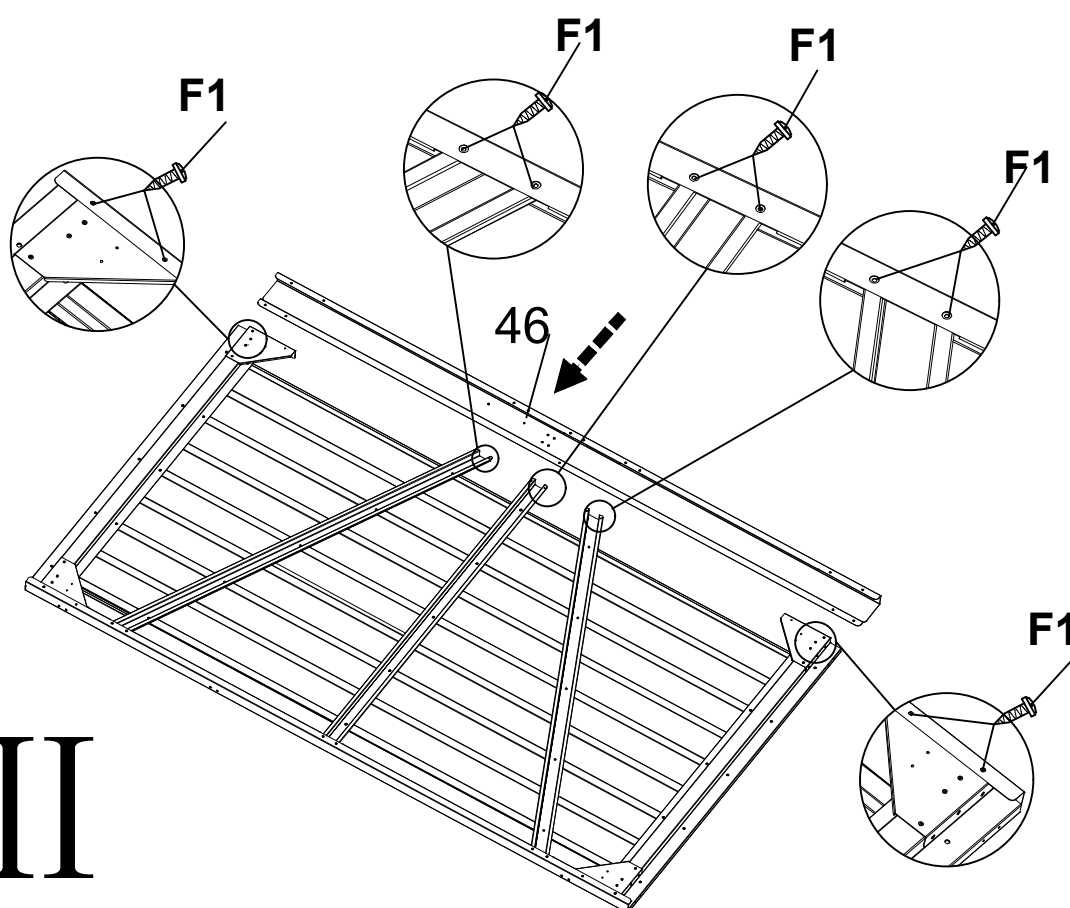
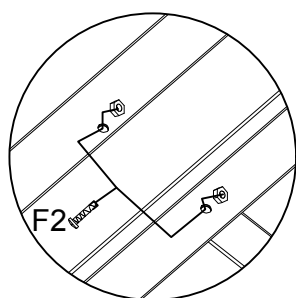
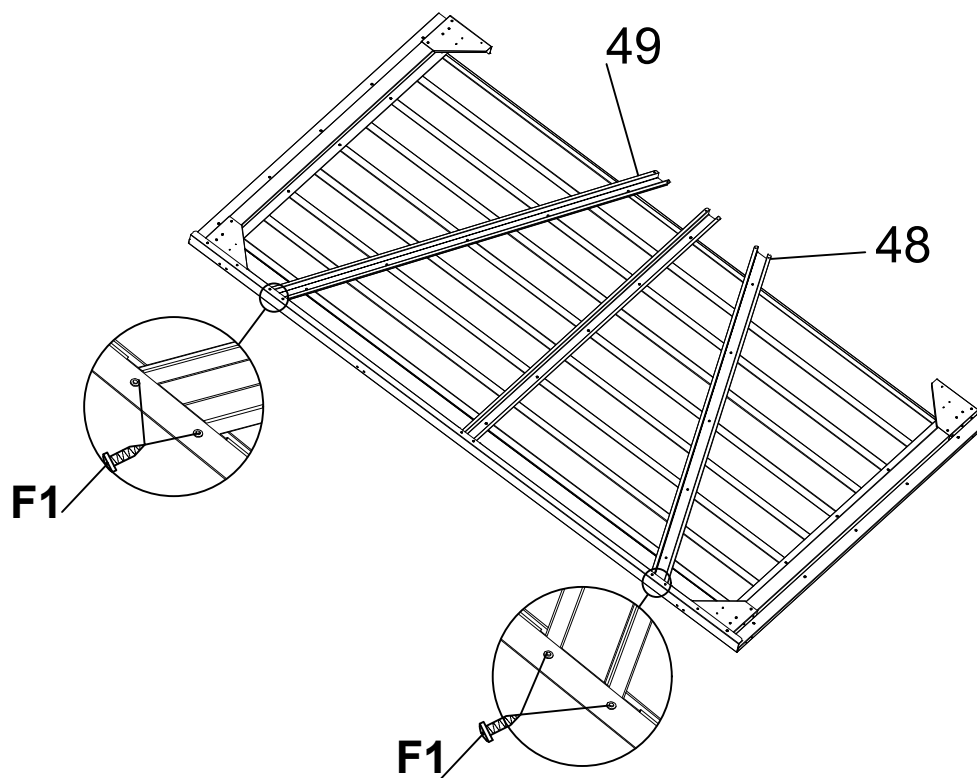

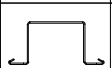
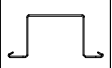
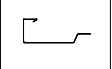
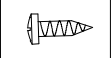

DEL	NR.	ST.
	48	1
	49	1
	46	1
	F1	

II

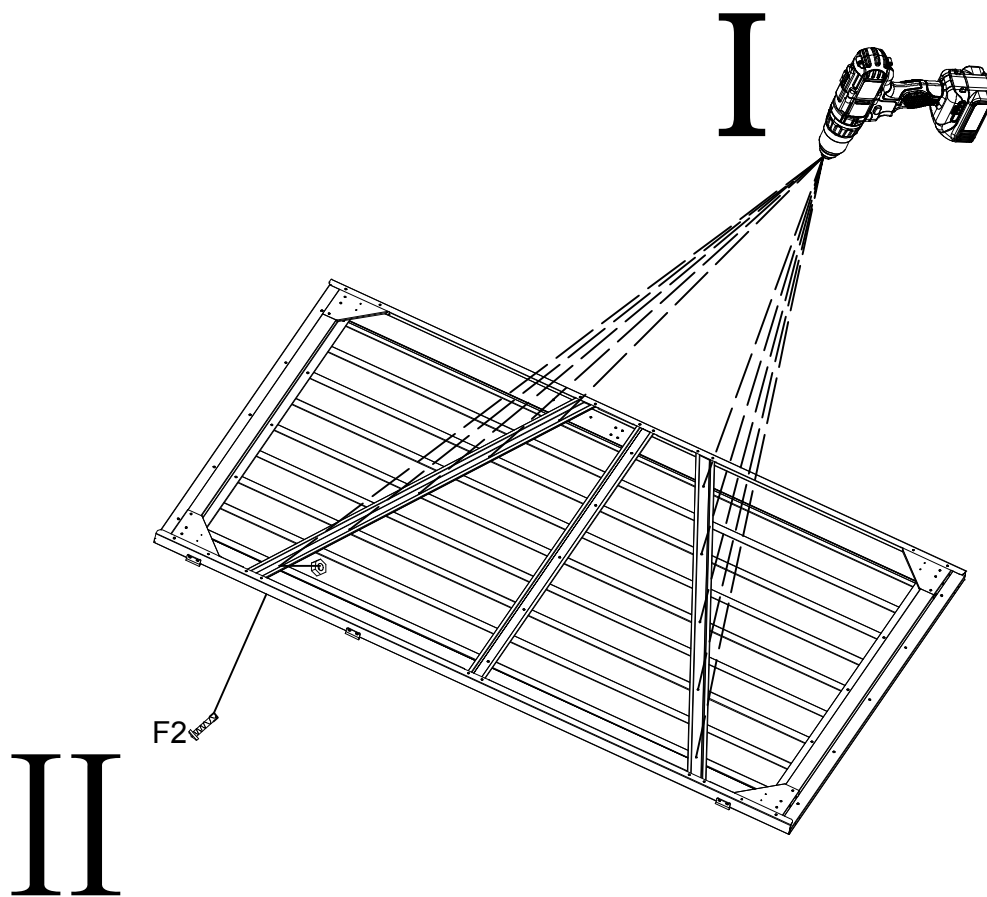
MONTERING AV PORTAR/DÖRR-10

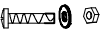



DEL	NR.	ST.
	F2	
		

Montera (B5) och (H1), (H2) med skruv (F1) på framsidan av sidoporten.

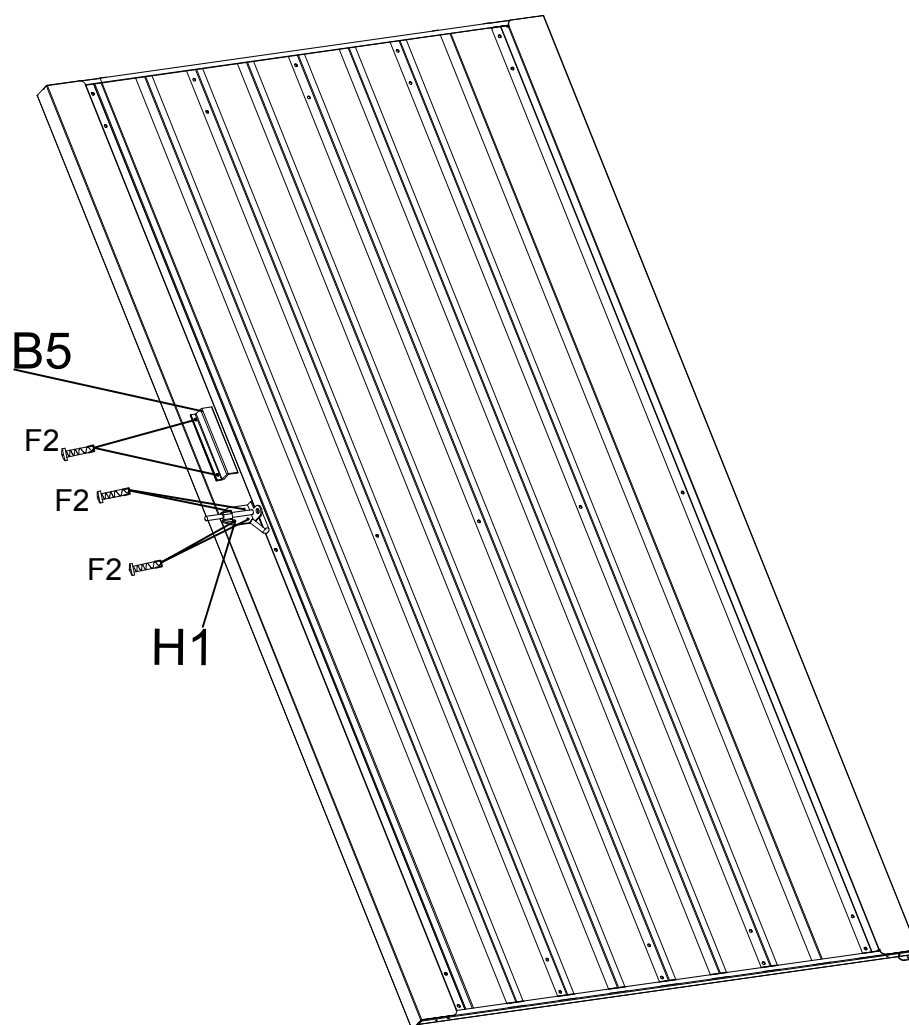

MONTERING AV PORTAR/D RR-11



DEL	NR.	ST.
	B5	1
	H1	1
	F2	

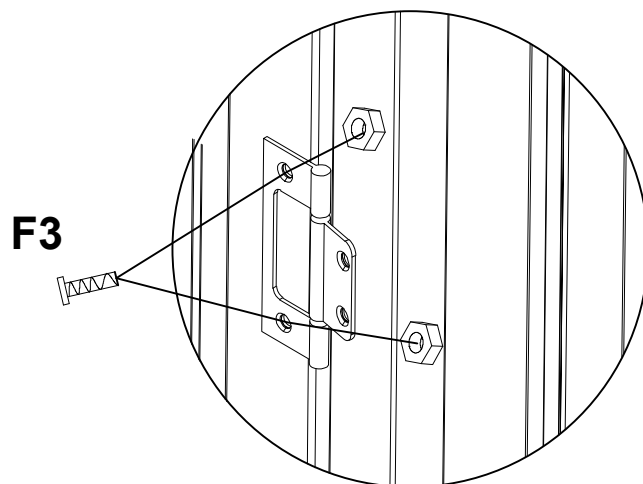
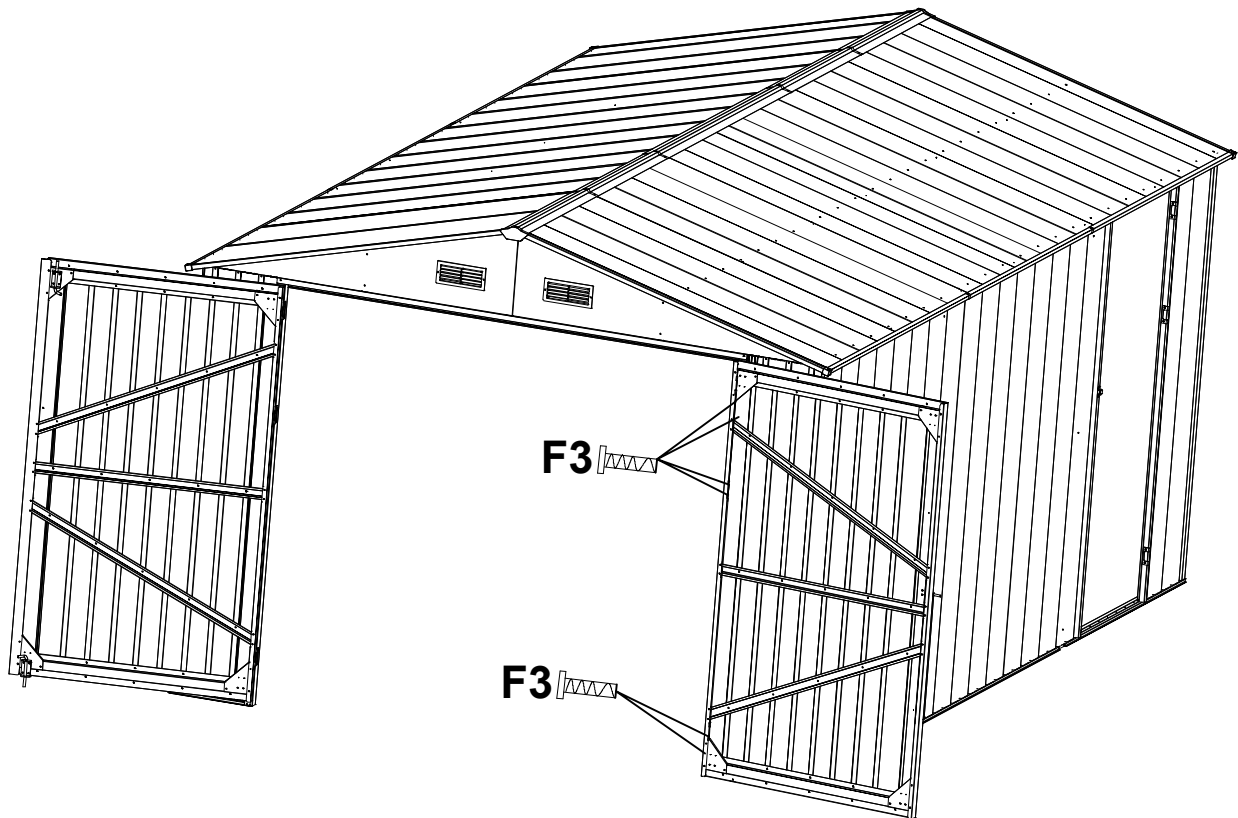

MONTERING AV PORTAR/D RR-12



DEL	NR.	ST.
 	F3	

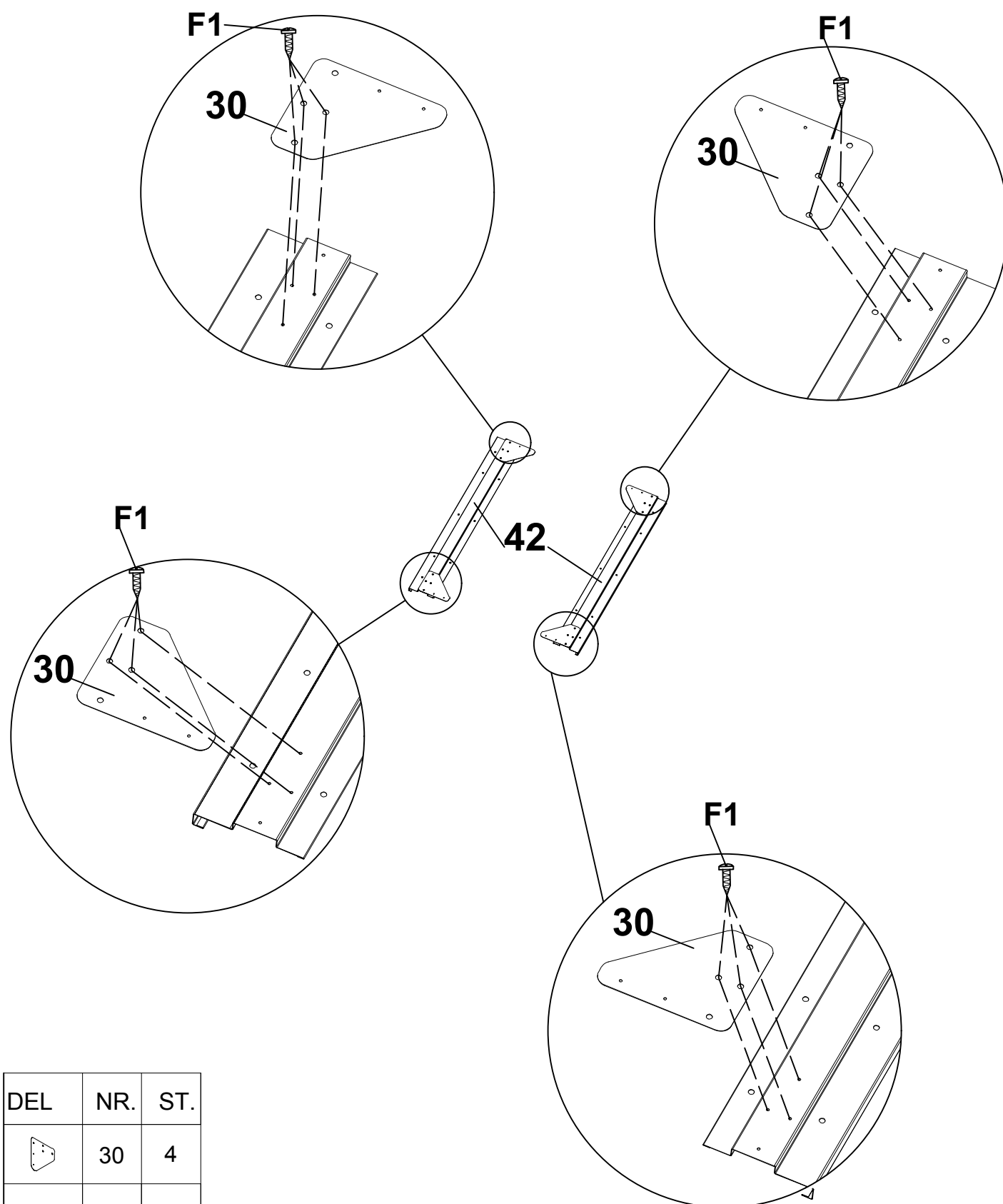



MONTERING AV PORTAR/D RR-13

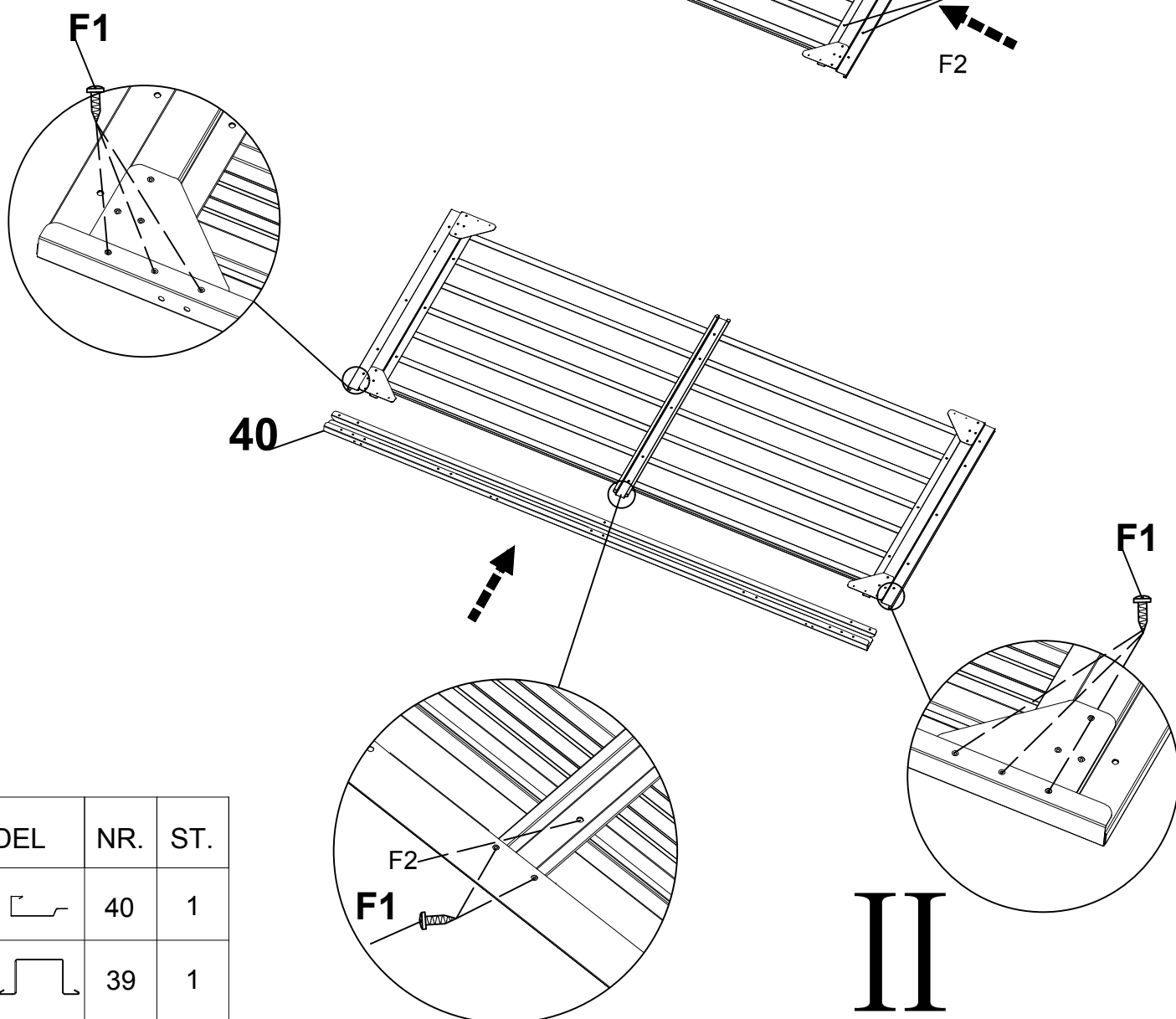
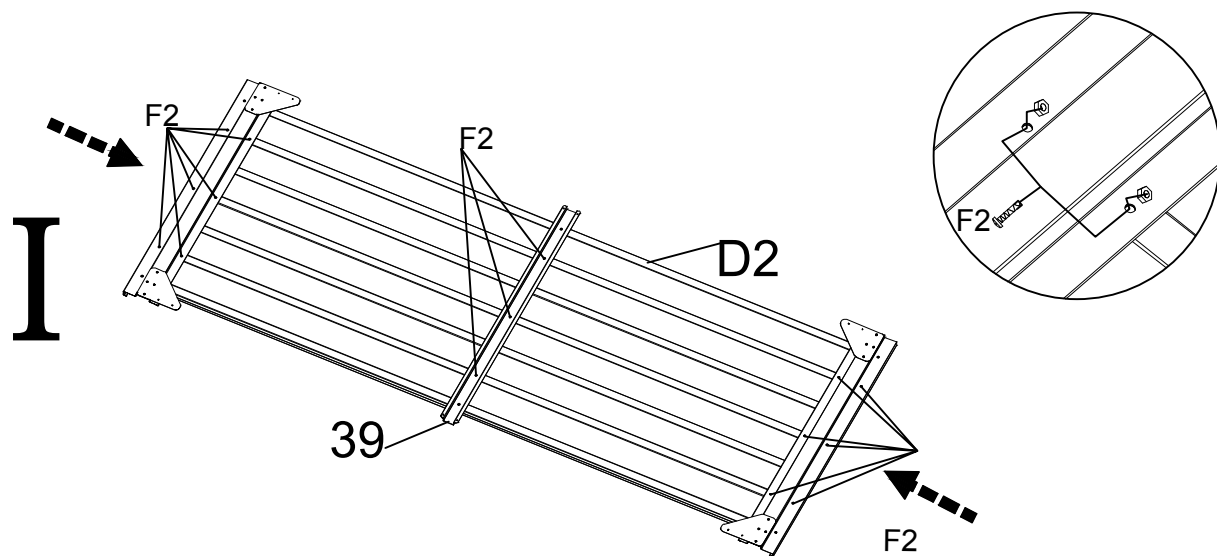

DEL	NR.	ST.
	30	4
	42	2
	F1	

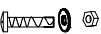

MONTERING AV PORTAR/DÖRR-14

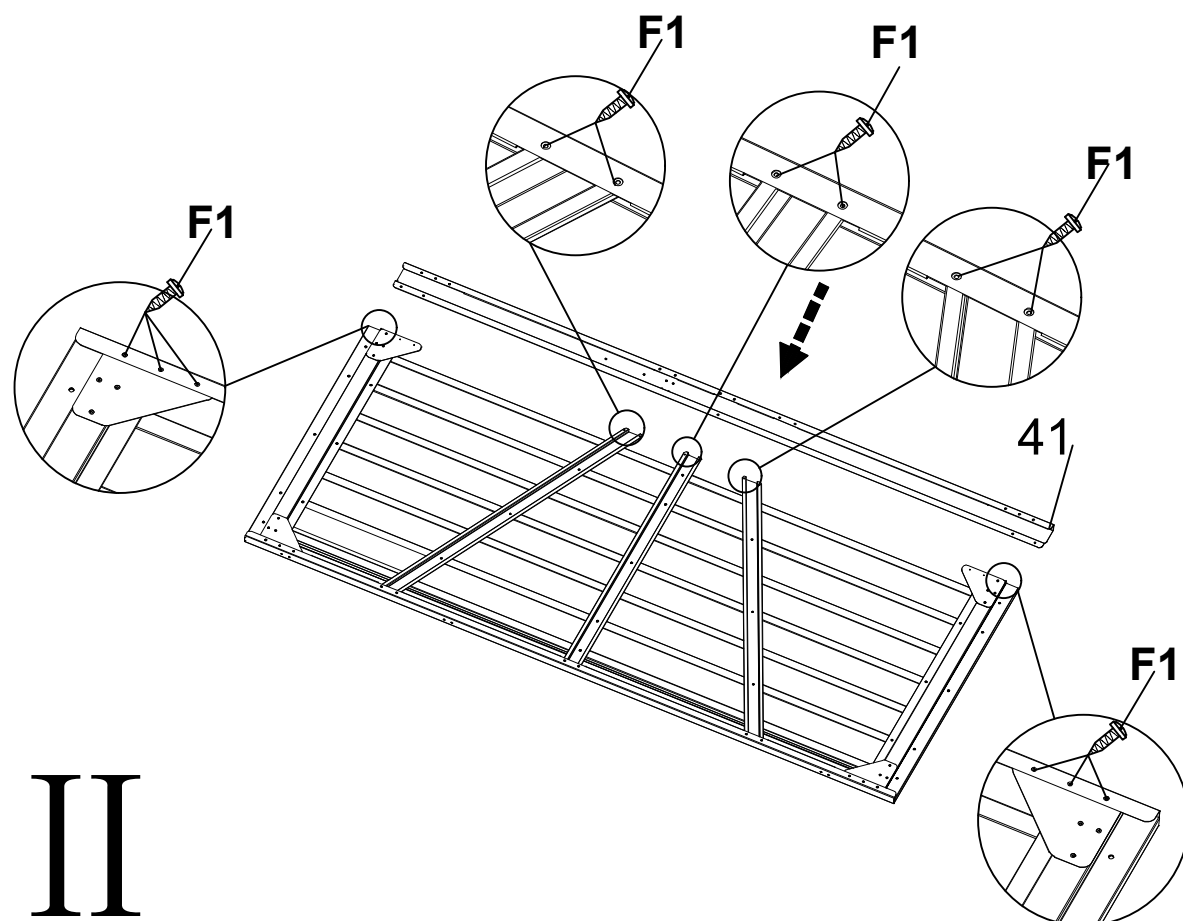
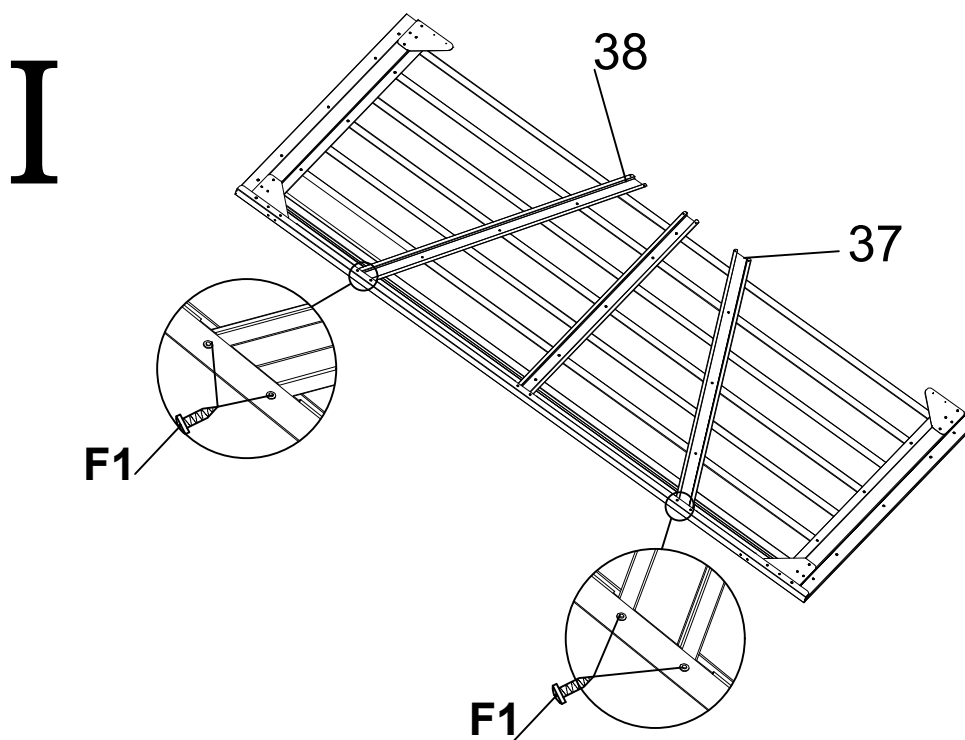

DEL	NR.	ST.
	40	1
	39	1
	D2	1
	F2	
	F1	

MONTERING AV PORTAR/DÖRR-15

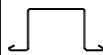

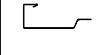
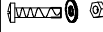
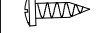

DEL	NR.	ST.
	37	1
	38	1
	41	1
	F2	
	F1	

MONTERING AV PORTAR/DÖRR-16

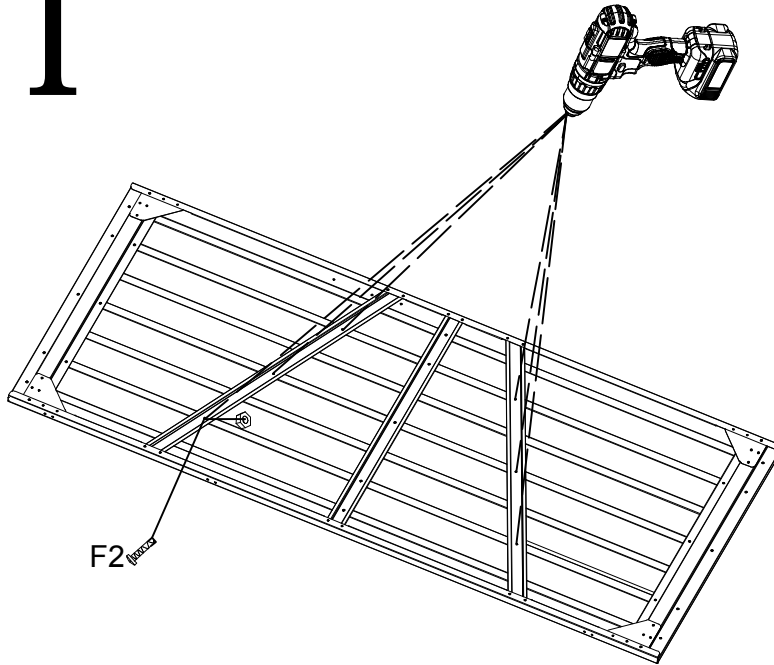
I



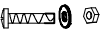



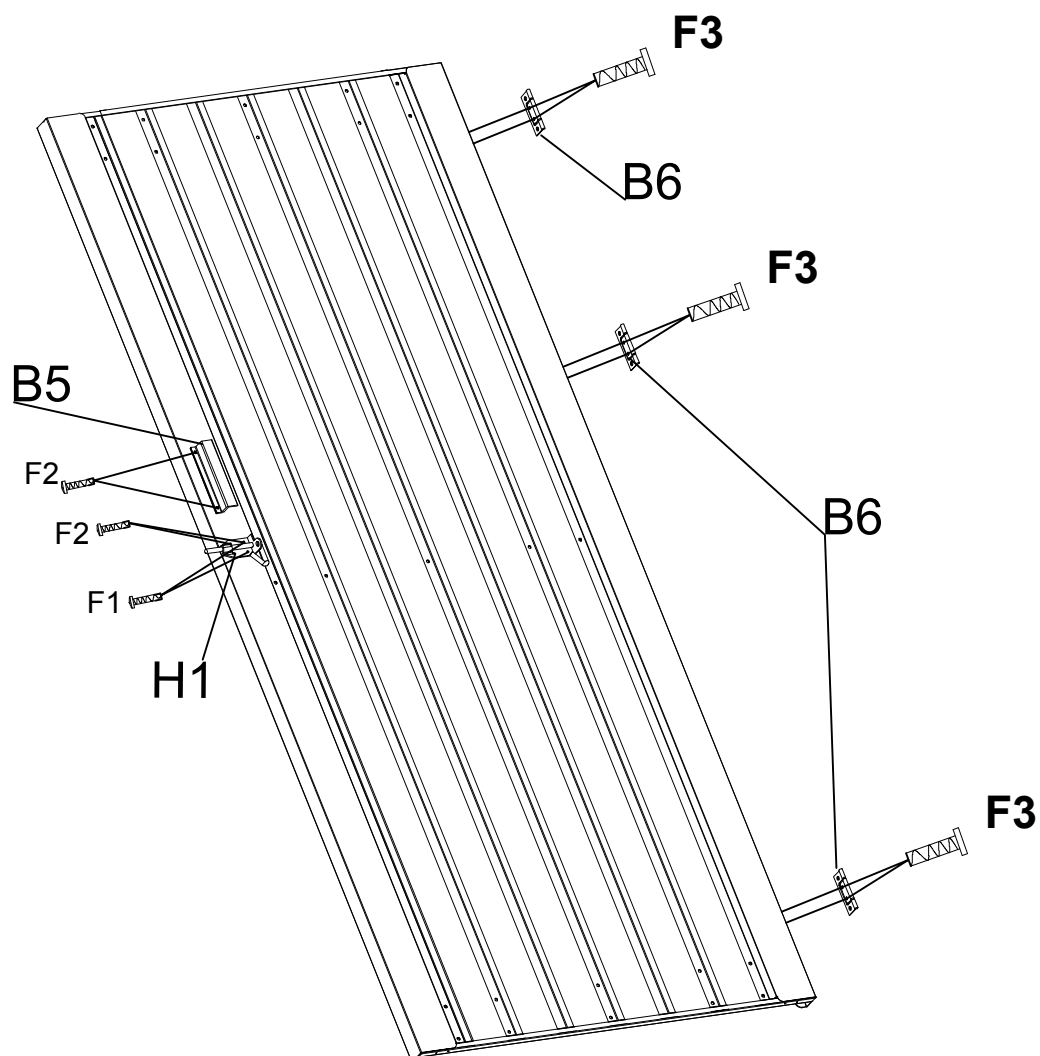

II

DEL	NR.	ST.
	F2	
		



MONTERING AV PORTAR/DÖRR-17

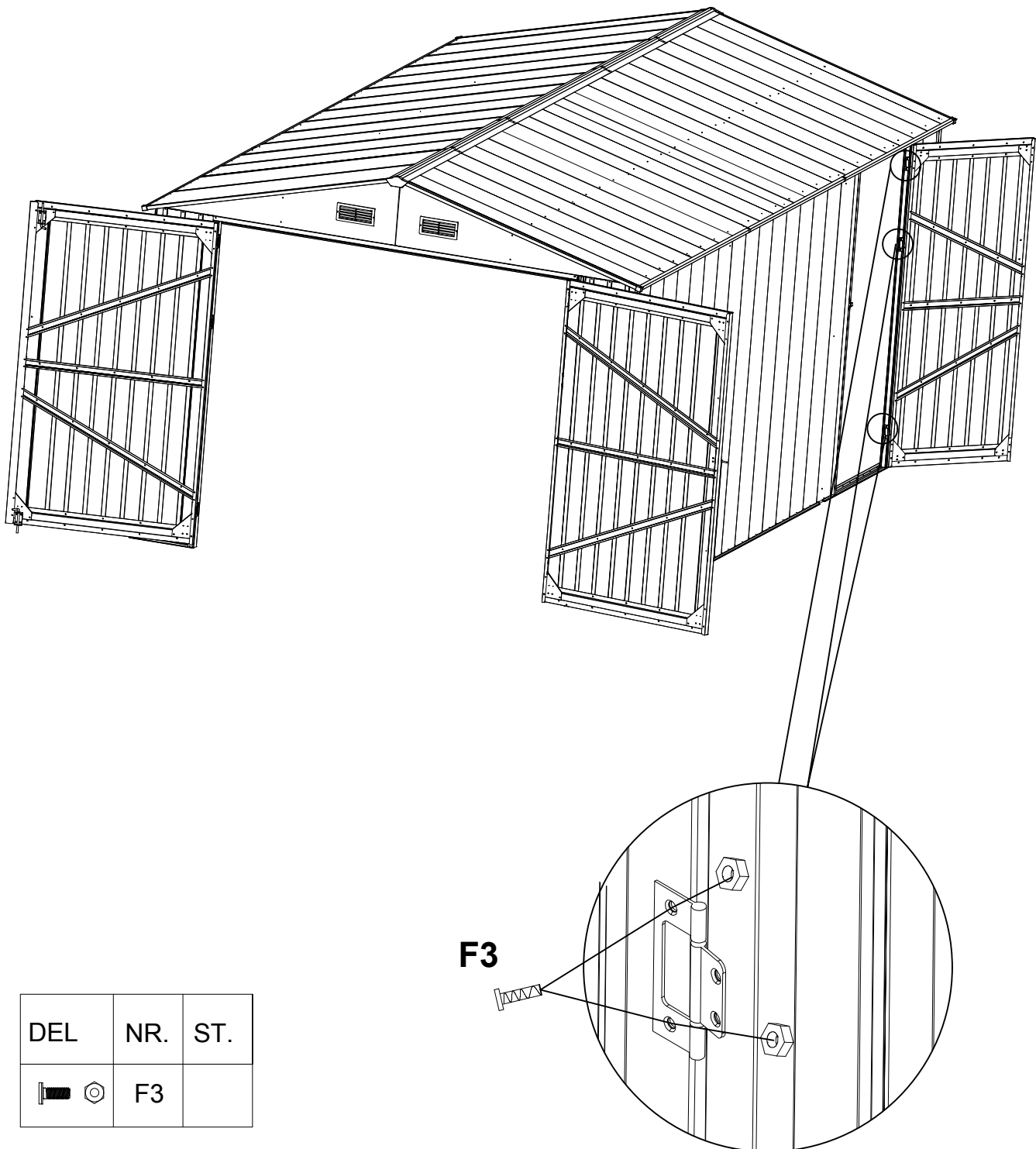

DEL	NR.	ST.
	B5	1
	B6	3
	H1	1
	F3	
	F2	
	F1	

MONTERING AV PORTAR/DÖRR-18



DEL	NR.	ST.
 	F3	