

ASSEMBLY MANUAL BRUKSANVISNING

Lyfco®

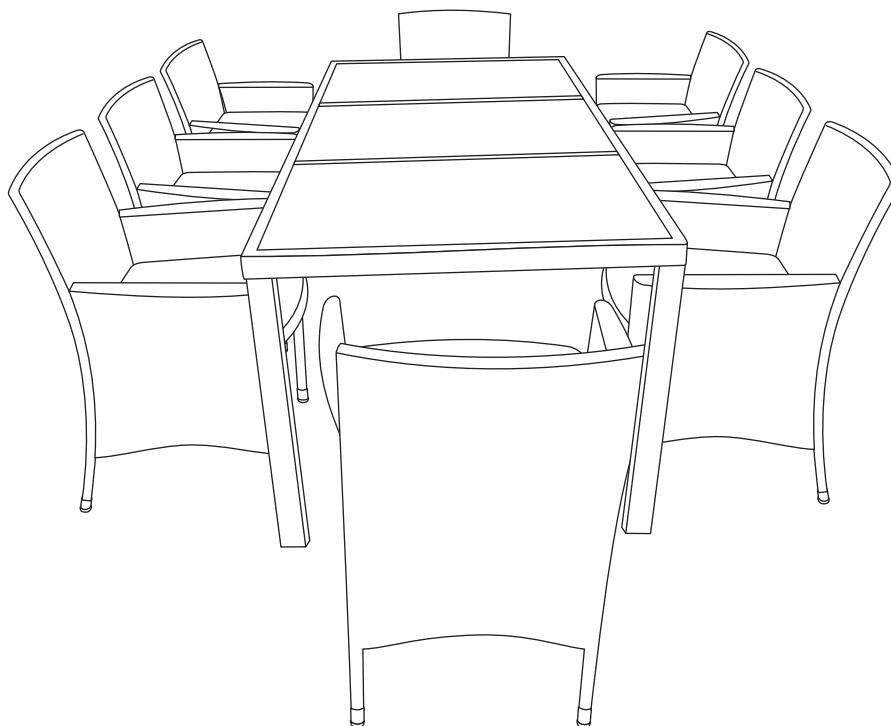

NOTE: 50% TIGHTEN BEFORE FIXING ALL BOLTS

VIKTIGT – LÄS MONTERINGSANVISNINGARNA NOGA INNAN DU BÖRJAR

Please don't remove the batch code sticker at back side of this product!
Any feedback please take picture of this batch code for traceability purpose

Ta inte bort etiketten med batchnummer som finns på möbeln. Om du behöver hjälp med service eller reklamation av din möbel – ange möblensbatchnummer till återförsäljaren, så att du kan få rätt reservdelar till just din möbel.

XX-YYWW

SKU: 166-1-40

MODEL NAME: Lysekil

MODELLNAMN: Lysekil

Konsumentkontakt

Arc E-commerce AB

Box 3124

13603 Haninge

Attention! Please note that at first all screws should be inserted slightly by hand! Turn 2-3 times so that the screw grips on its own and connects all elements loosely. The screws must only be driven in tightly when all elements are connected with each other in this way. Otherwise the setup won't be possible. Only by driving them in tightly afterwards, small deviations of the borehole or the welded joints, which always occur with handcrafted products, can be compensated.

Var uppmärksam! Sätt först i samtliga skruvar löst. **Dra inte åt**, för då finns risk att skruvhålen inte passar.

Notes on an optimized assembly:

Before you completely tighten the screws, check carefully all the screws and tighten them (only) to the extent that the product remains (especially chairs or loungers) still under load. If you are sure that your product can withstand load, place it on a solid, level ground and put some weight on it, please carefully and always with cushions. The various components can then align with each other. Then tighten completely the screws. Thus you achieve an optimal alignment of the product and prevent wobbling. Don't sit, find some weight.

Innan du drar åt skruvarna helt, gör såhär för bästa resultat:

Ställ möbelen på en helt slät yta och lägg ett tillräckligt tungt föremål (ca 10-15kg) på den, så att alla ben nuddar marken. Skruva därefter i skruvarna helt. Obs – använd inte din kroppstyngd, då det är för mycket vikt. Om du följer dessa råd, blir din möbel stabil.

Om du inte följer dessa instruktioner kommer möbelen att bli ostadiga och "vickiga" då produkten upplevs ojämn.

Your new product was made by hand. Slightly irregularities are rather seen as a quality attribute than as a reason for complaints.

Din nya möbel är handgjord. Små avvikelser kan därför förekomma och är ett kvalitetsattribut snarare än ett fel.

Tip: Always fully insert the hex key inside designated notch of screw.

Tips: Var noga att alltid sätta in insexnyckeln helt ner i skruven.

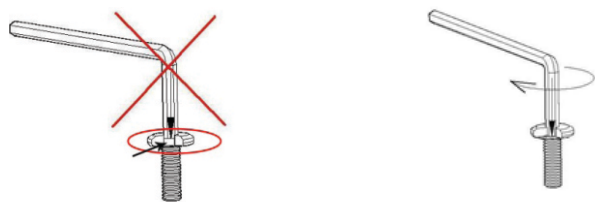

If you don't do that and slip out of the screw, the screw will suffer damage and it can cause the screw head to become round inside you won't be able to find grip with the hex key anymore!

Om du inte gör det finns risk att insexnyckeln slinter, vilket skadar skruven. Skruven kan då bli obrukbar.

✘ DONT'S

Don't use this product if parts are missing, damaged or worn down.

Don't use any electronic tools to set up these products. The high energy of these electronic tools will cause screws to be overtightened and therefore they won't grip.

Don't overtighten screws or bolts. Only tighten the screws entirely after the product is completely set up. You shouldn't sit or stand on it.

Don't let your product stand in the rain. Protect it from weather impacts. In times of freeze and over the winter, we suggest you to store the product in a covered dry place.





✘ VIKTIGT

Använd inte den här produkten om delar saknas, är skadade eller utslitna.

Använd inte elektriska skruvdragare för att montera produkten. Den höga kraften i elektriska verktyg kommer dra åt skruvarna för hårt vilket kan skada gängorna.

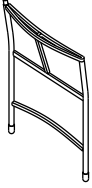
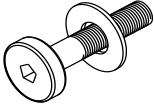
Spänn inte skruvar eller muttrar för hårt. Dra åt alla skruvar efter att hela möbelen monterats. Stå eller sitt inte på bordet.

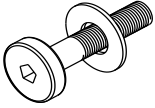
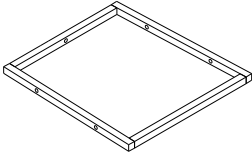
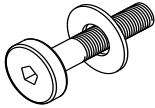
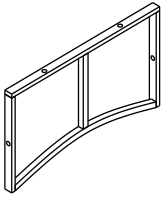
För att förlänga livslängden på möbelen, undvik att låta den stå i regn. Under vintertid rekommenderar vi att möbelen förvaras inomhus, i torr miljö.

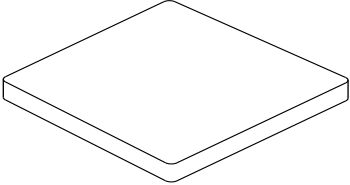
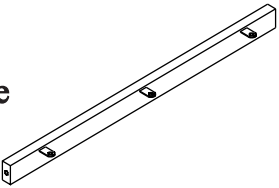
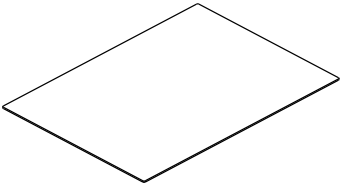
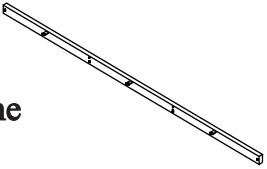
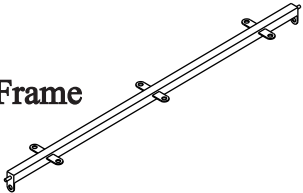
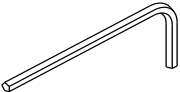
<u>Component</u>			<u>Hardware</u>		
A	Right Frame	 8 pcs	1	M6 x 40	 44 pcs
B	Left Frame	 8 pcs	2		
C	Chair Back Frame	 8 pcs		M6 x 30	 48 pcs
D	Chair Seat	 8 pcs	3	M6 x 15	 12 pcs
E	Chair Front Panel	 8 pcs	4		
F	Table Leg	 4 pcs			 8 pcs
G	Short Table Top Frame	 2pcs	5		 3pcs
H	Long Table Top Frame	 2pcs	6		
I	Middle Table Top Frame	 2pcs			 1 pcs

ASSEMBLY THE SINGLE CHAIR

STEP 1

Connect Chair Seat (D) & Chair Front Panel (E) with Bolt (2)

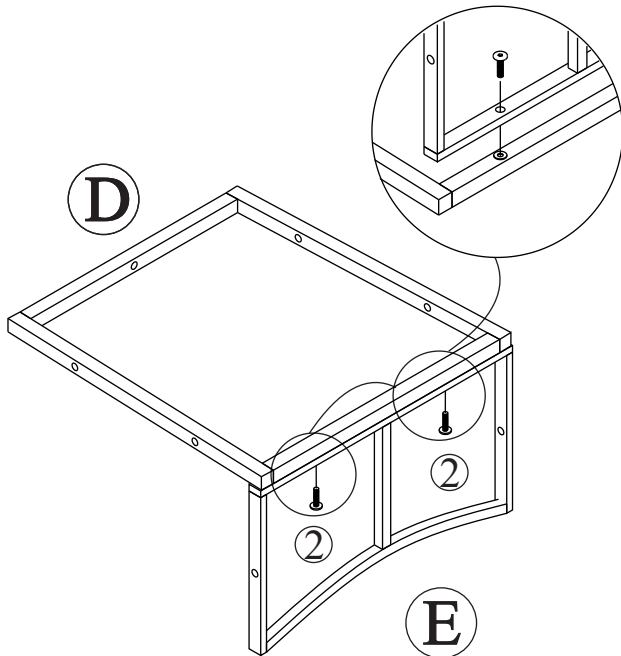

STEP 2

Connect the part from STEP 1 & Right Frame (A) with Bolt (1) & (2)

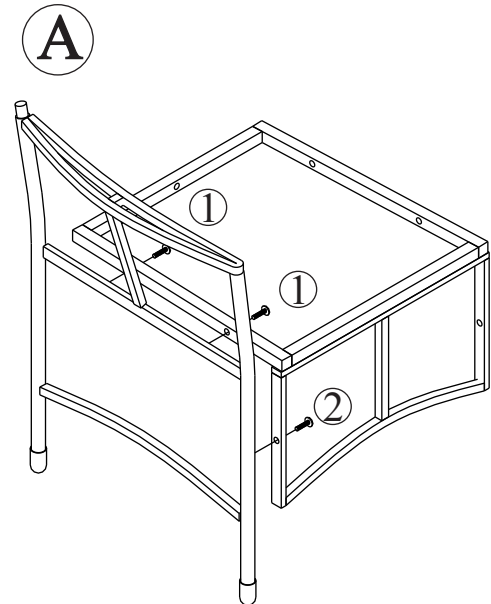

STEP 3

Connect The Part From STEP 2 & Left Frame (B) with Bolt (1) & (2)

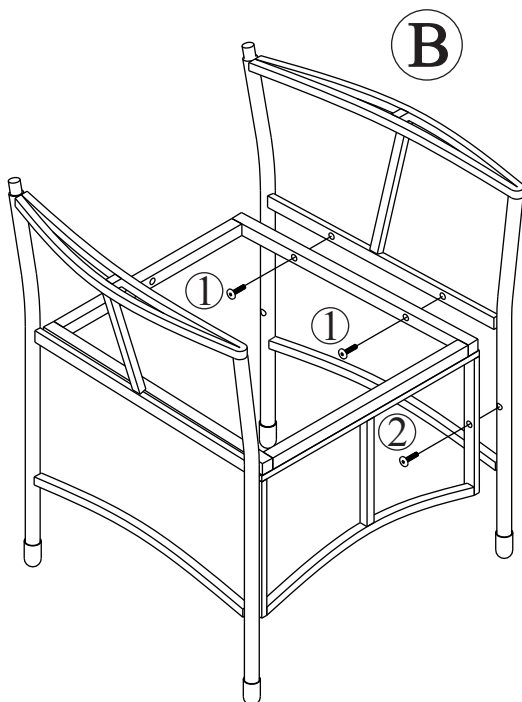

STEP 4

Connect The Part From STEP 3 & Chair Back Frame (C)

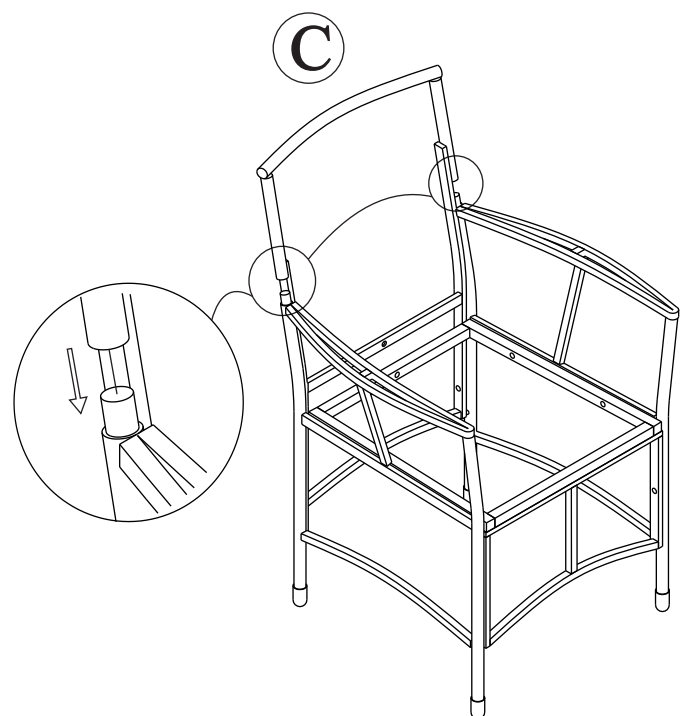

STEP 5

Connect The Part From STEP 4 with Bolt (1) & (2)

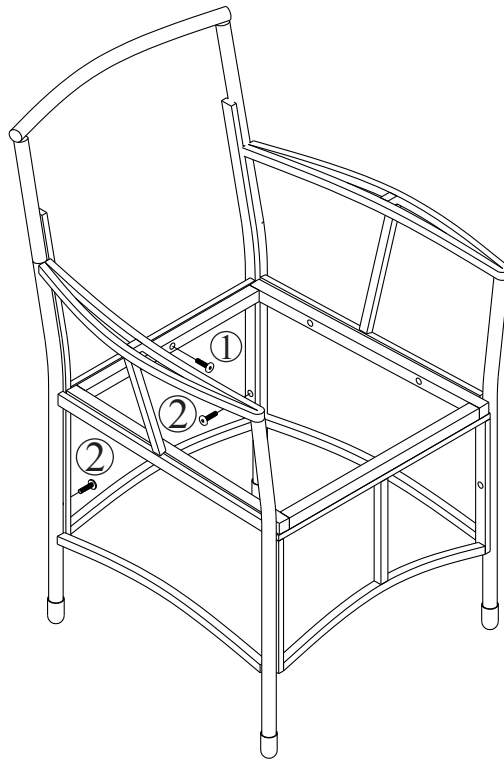

STEP 6

Put On Chair Cushion (4) to Complete the single Seat Chair

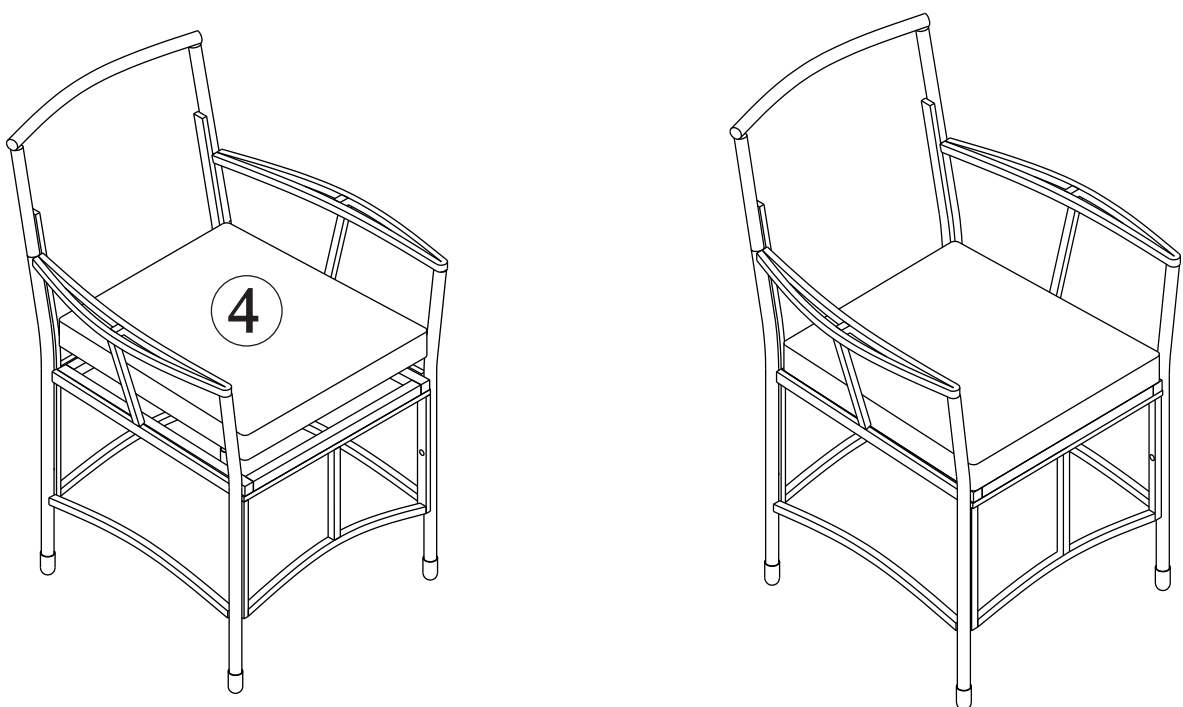

ASSEMBLY THE TABLE

STEP 7

Connect Short Table Top Frame (G), Middle Top Frame (I) & Long Table Top Frame (H) with Bolt (1) & (3)

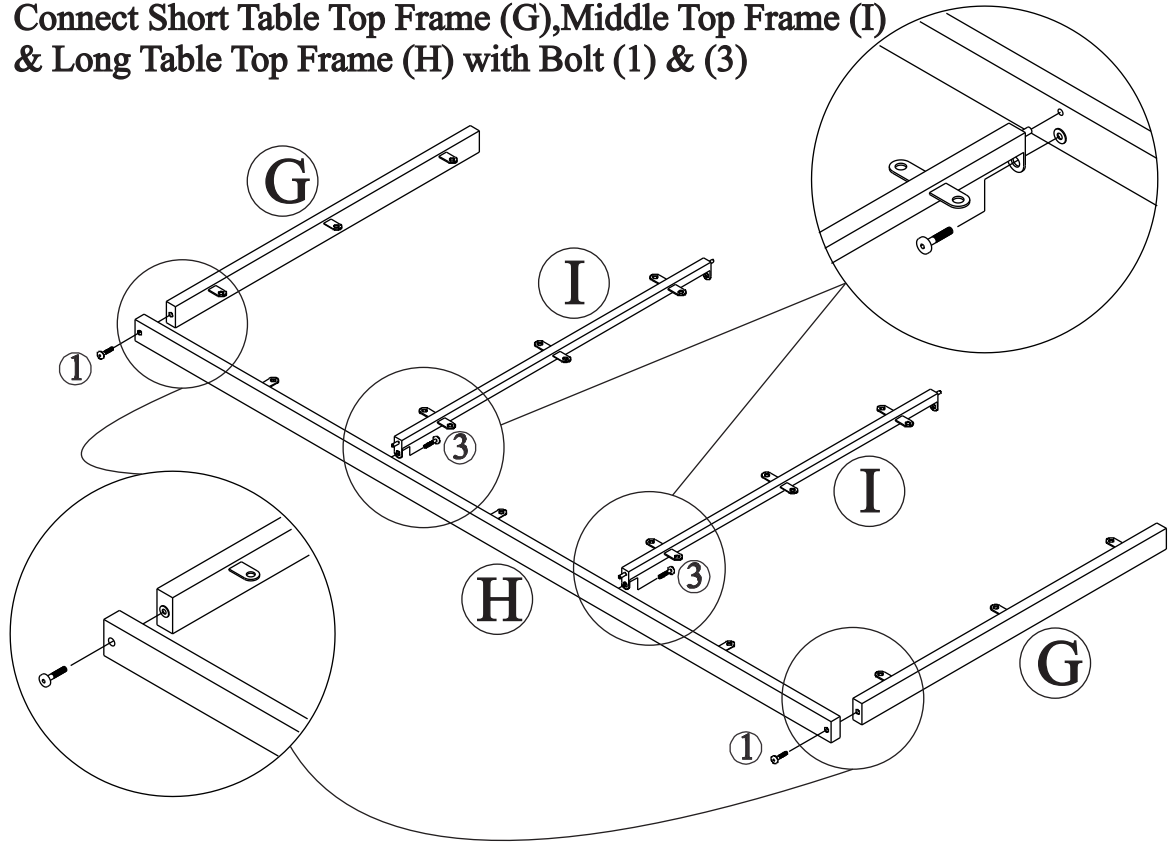

STEP 8

Connect The part from STEP 7 & Long Table Top (H) with Bolt (1) & (3)

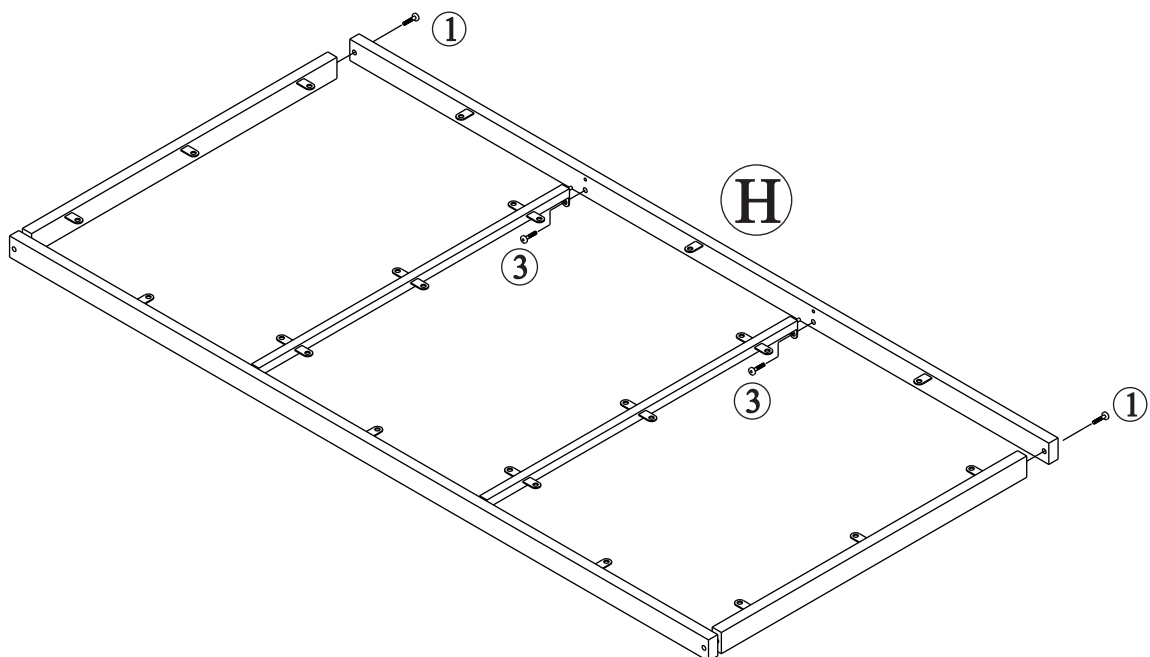

STEP 9

Connect The Part from STEP 8, Table Leg (F) & tighten Table Leg (F) with STEP 8

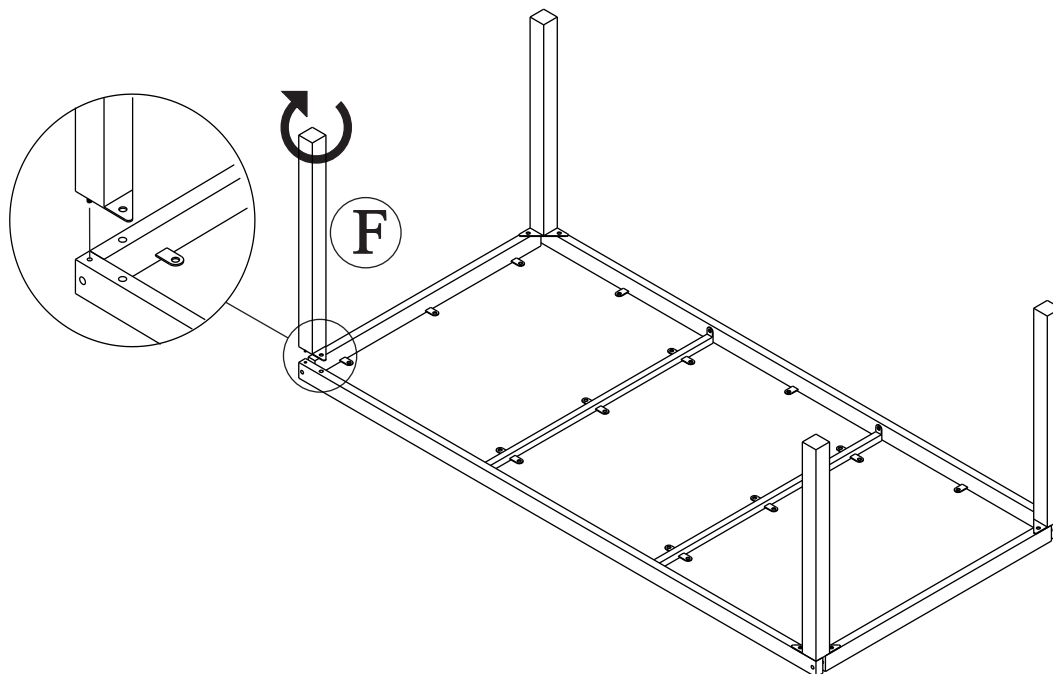

STEP 10

Connect the part from STEP 9 with Bolt (3)

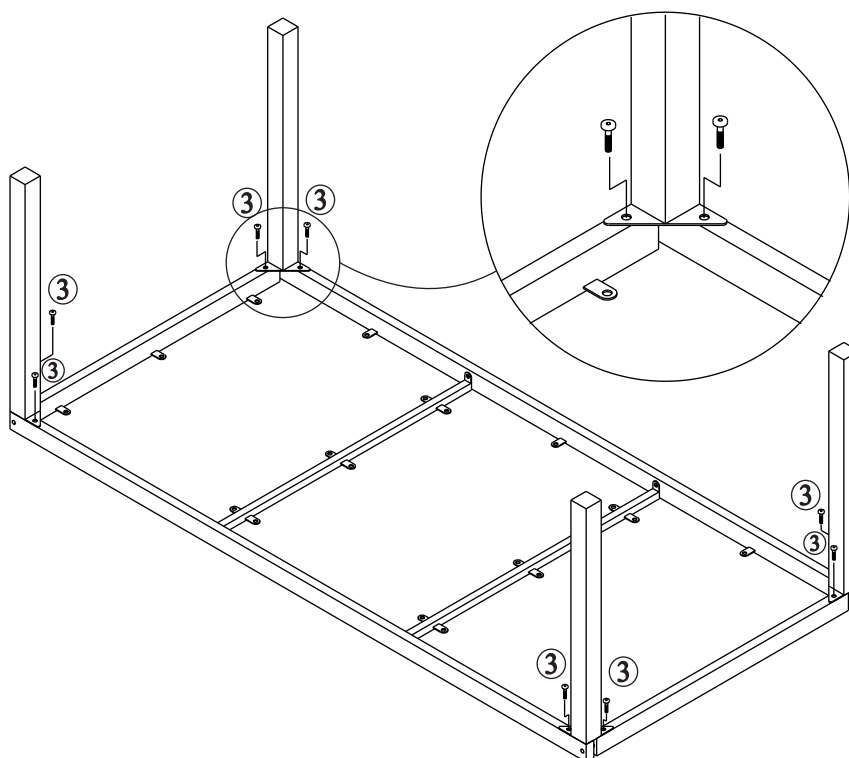

STEP 11
Put on Table Glass (5) to finish the Table

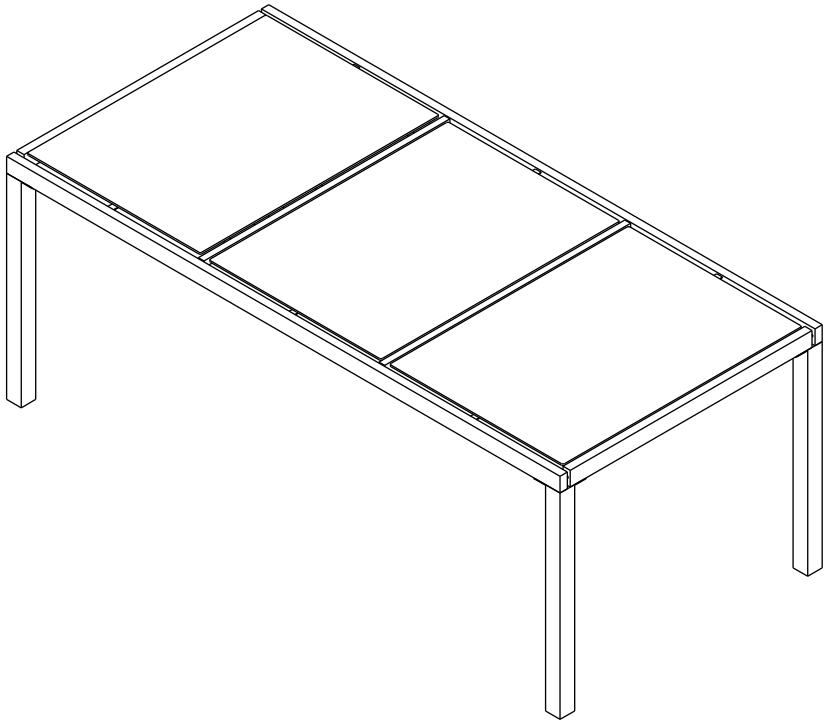
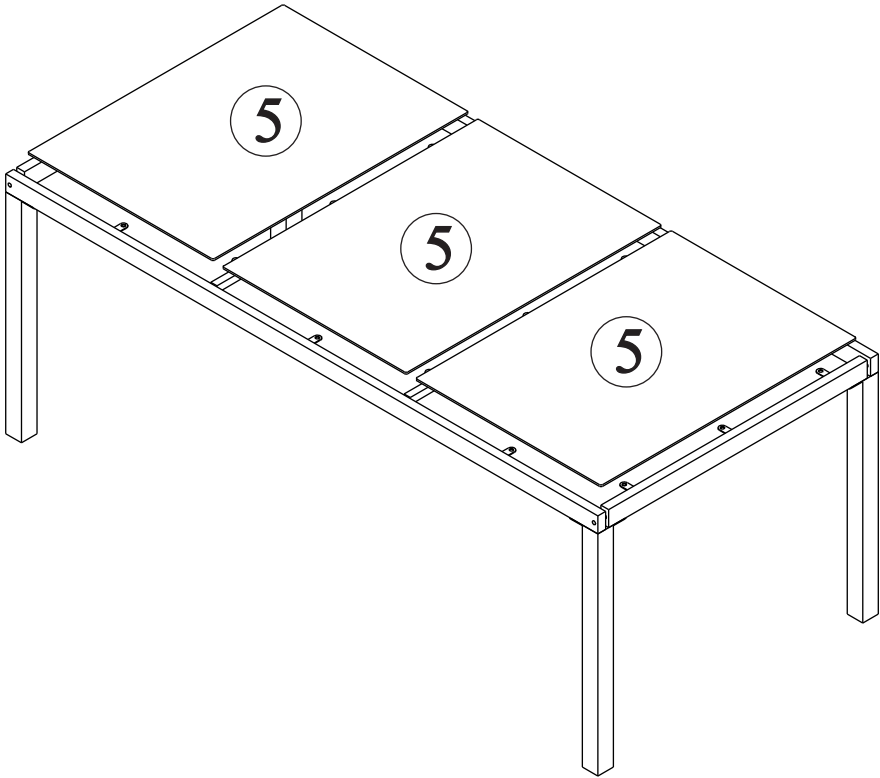

FINISH