

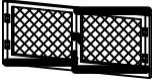

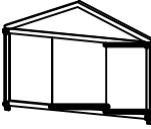







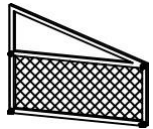
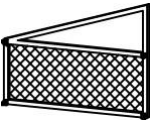
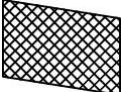
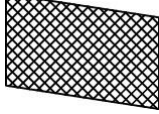
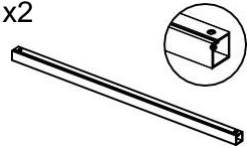
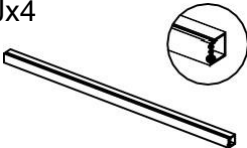
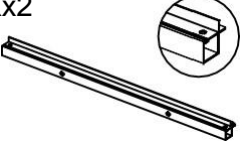
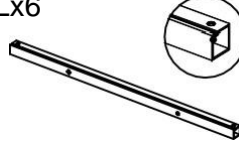
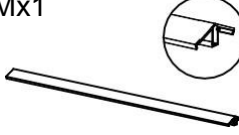
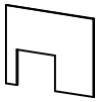
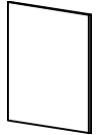

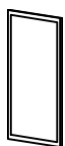
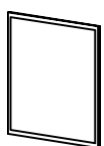
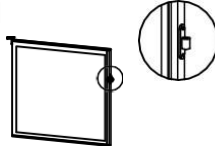
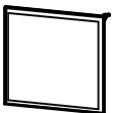
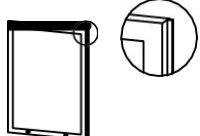
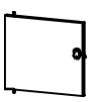
CHICKEN COOP INSTRUCTION

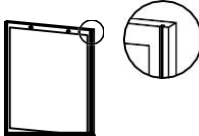
Ax1 	Bx1 	Cx1 	Dx1 	Ex2 
Fx2 	Gx1 	Hx2 	Ix2 	Jx4 
Kx2 	Lx6 	Mx1 	Nx2 	Ox1 
Px2 	Qx2 	Rx2 	Sx1 	Tx1 
Ux1 	Vx1 	Wx1 	Xx1 	Yx2 
Zx1 	AAx1 	ABx48 	ACx4 	ADx8 
 M8	 M6	$\frac{\text{mm}}{\text{inch}}$	 2x	

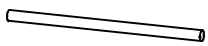
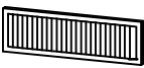
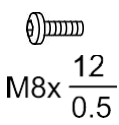
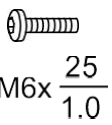
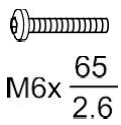
①

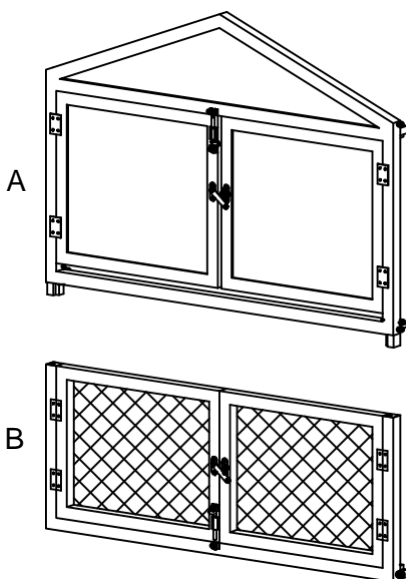

ABx2

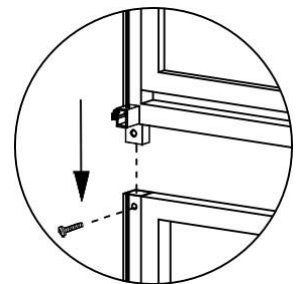
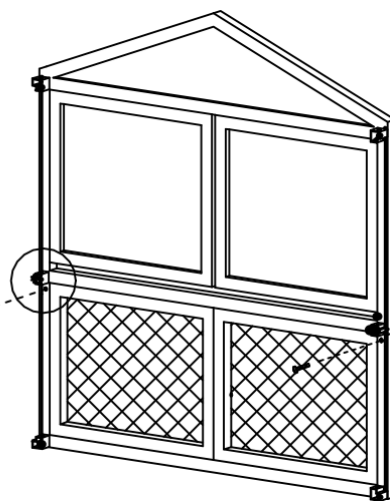

AB x2

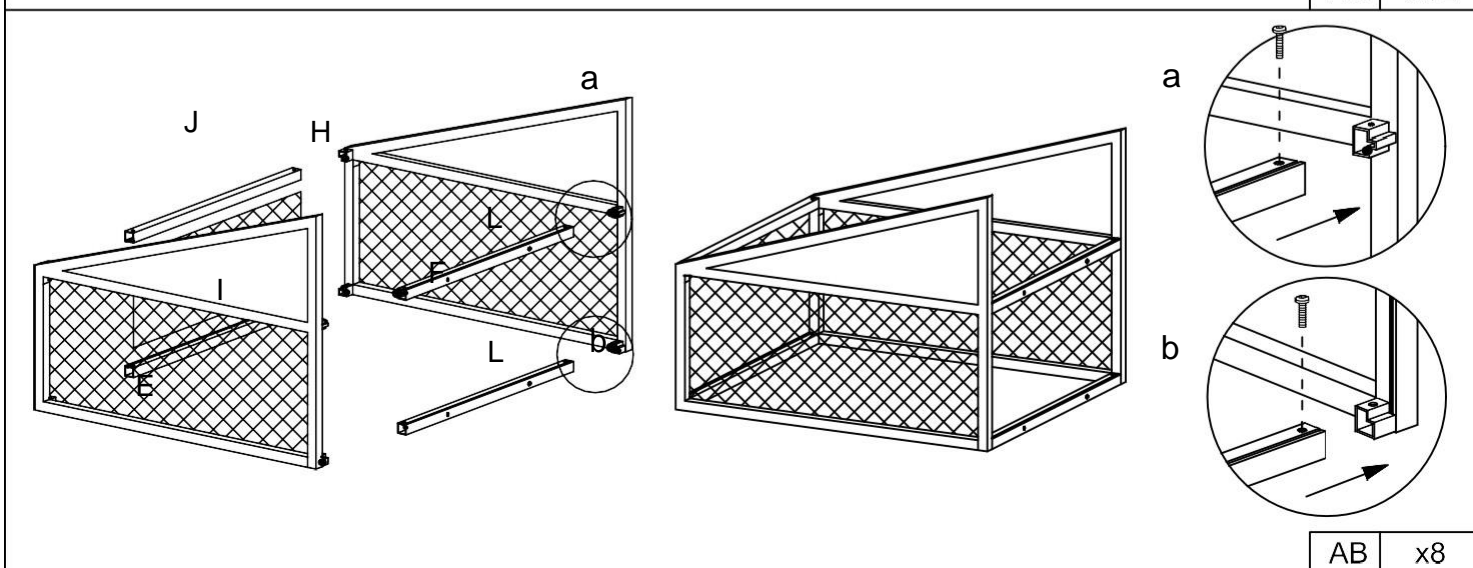
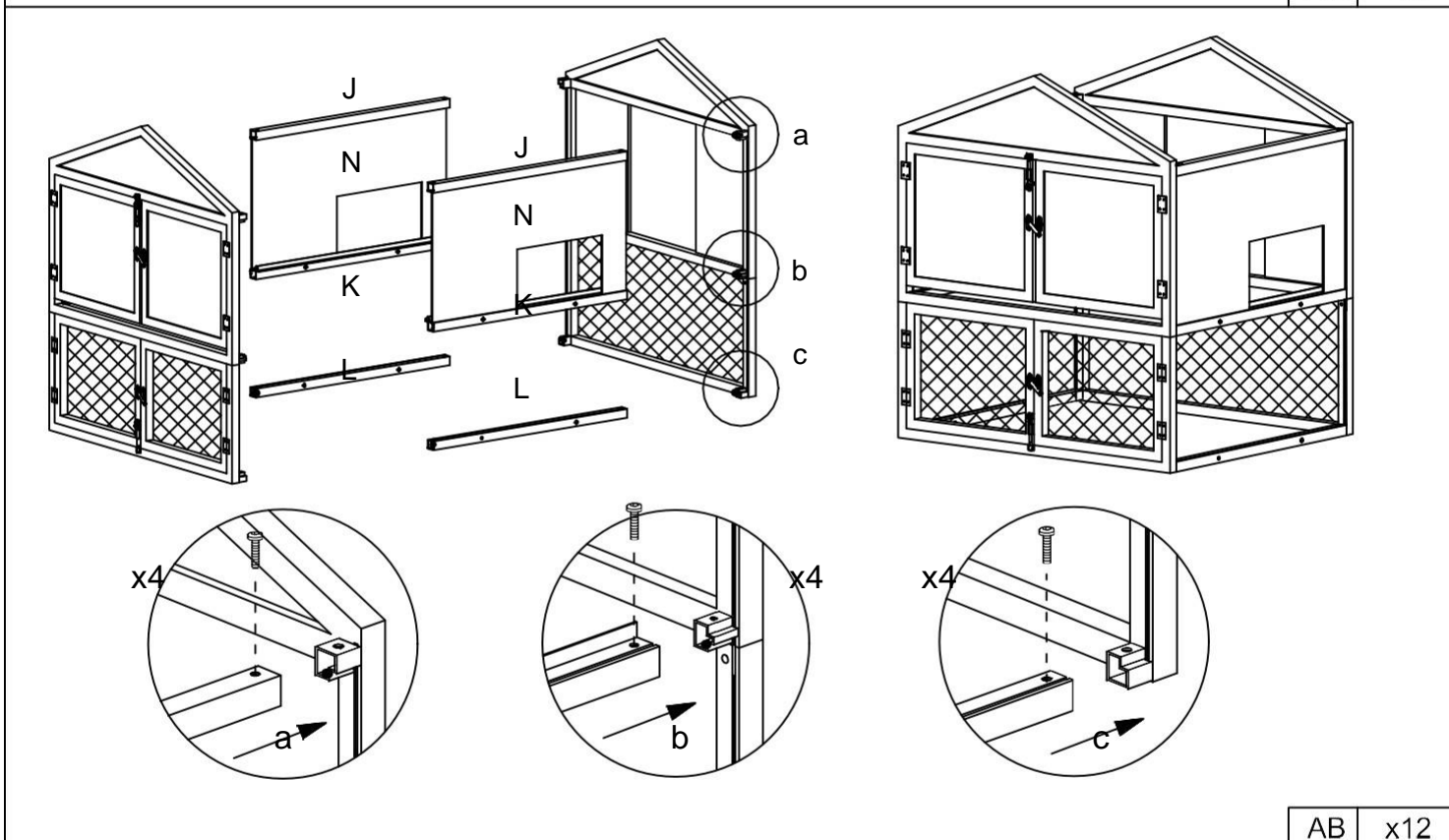
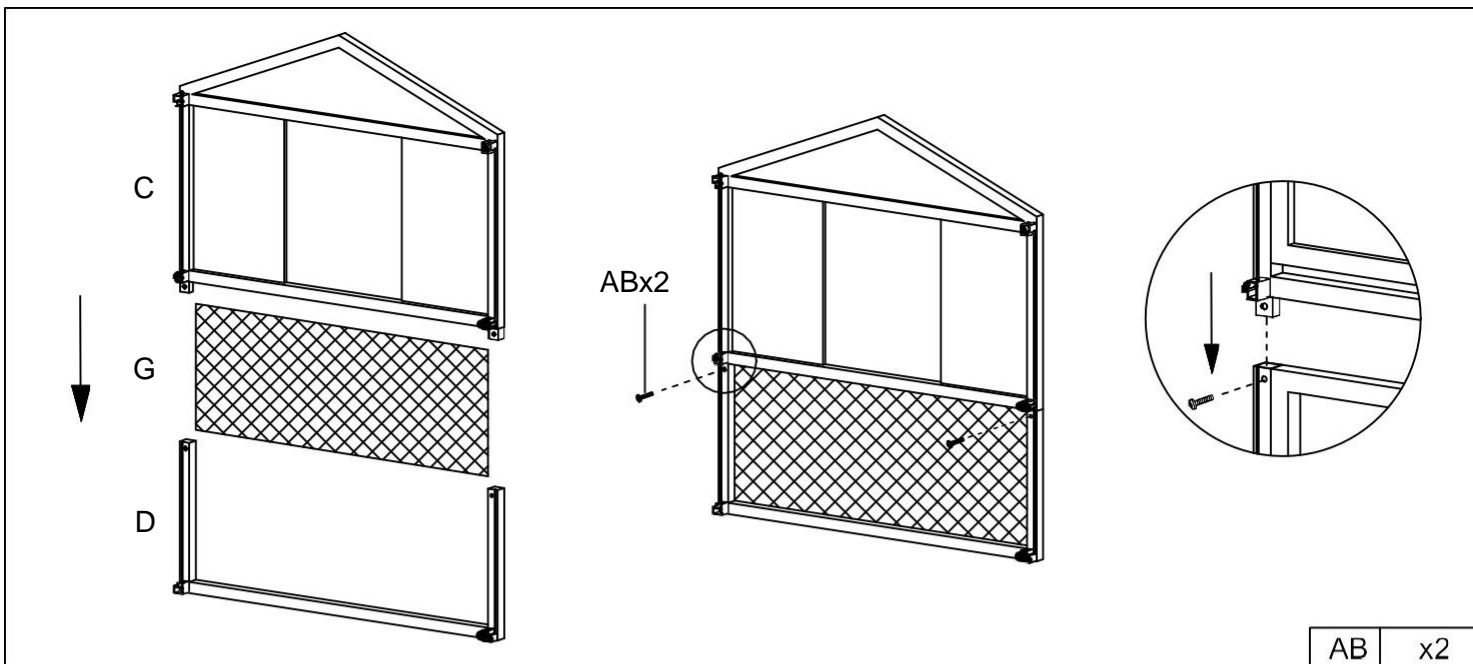

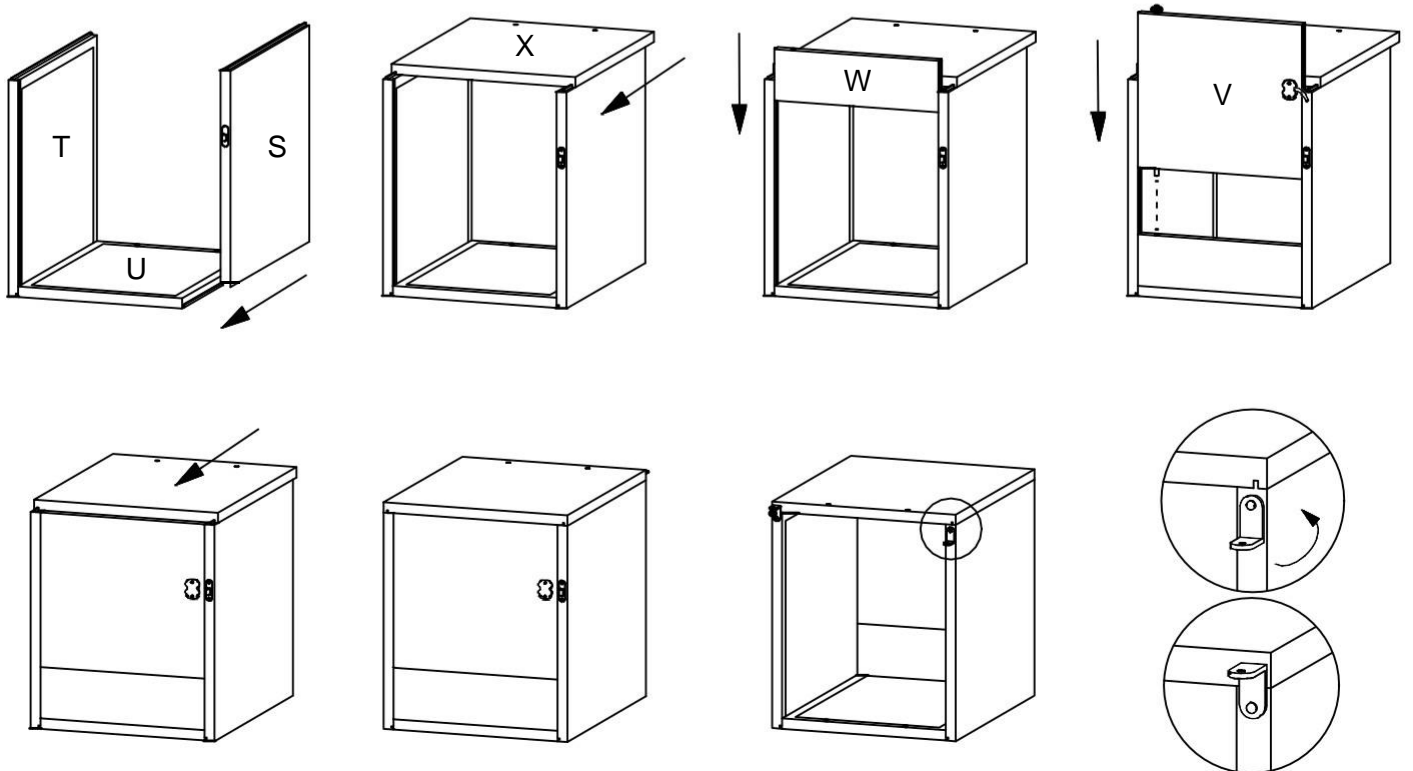
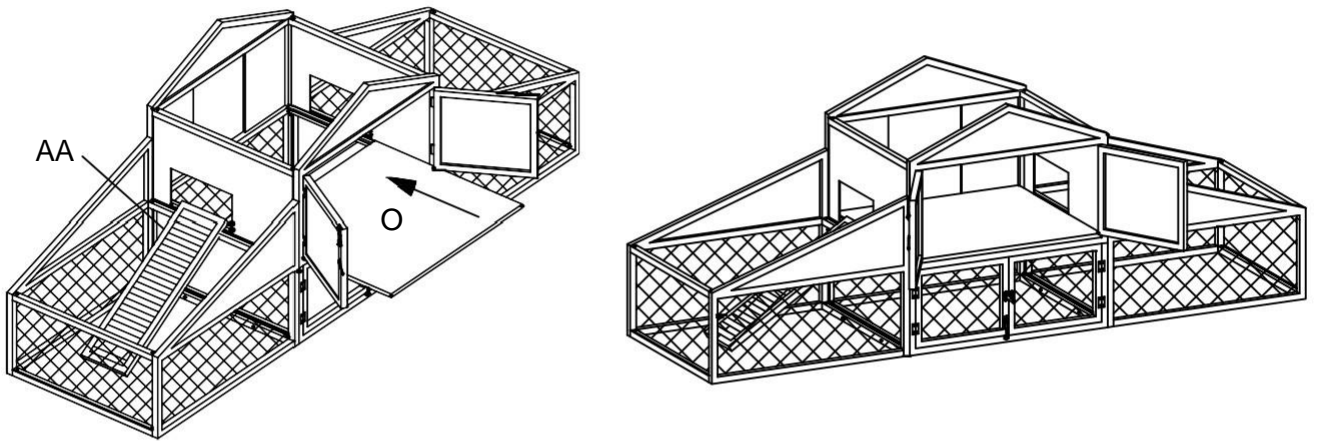
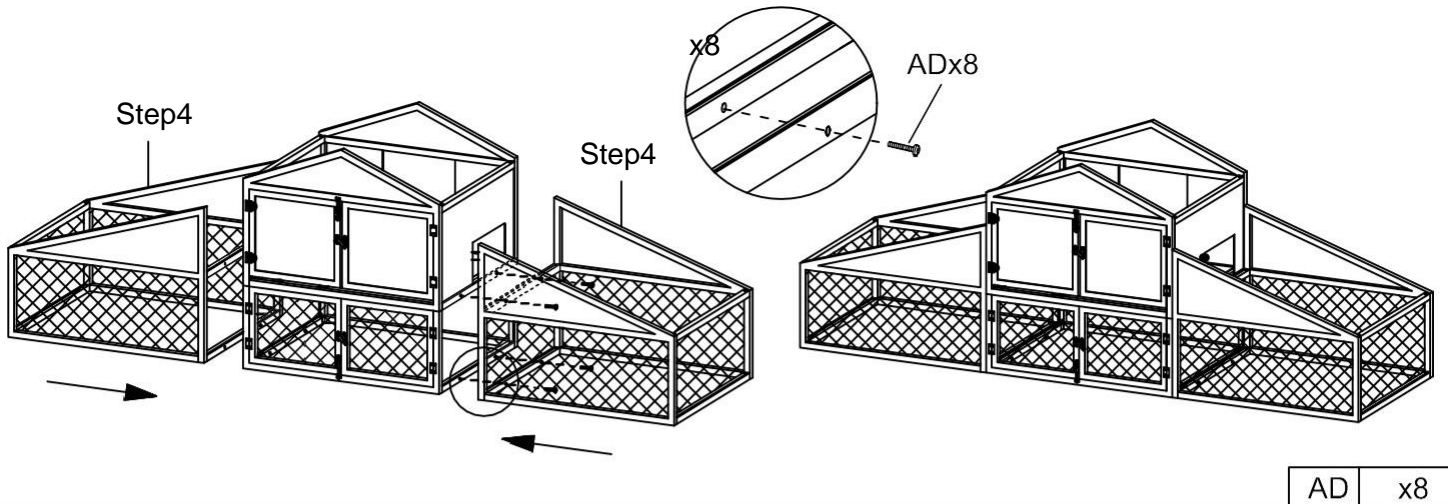

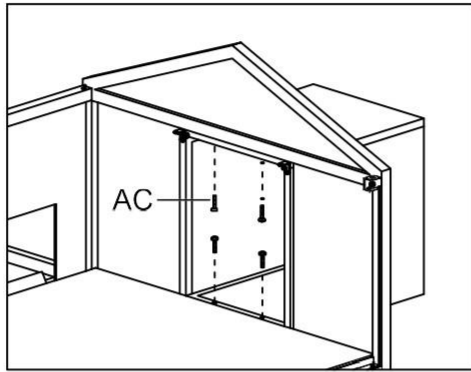
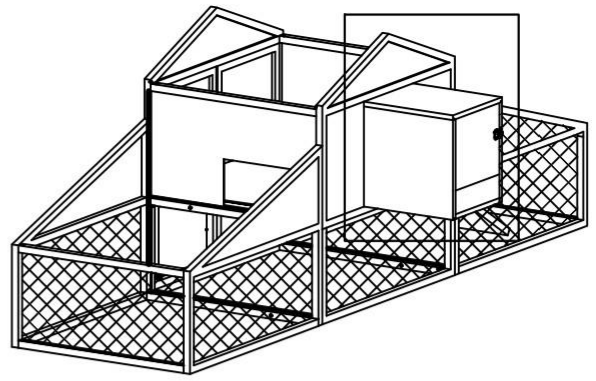
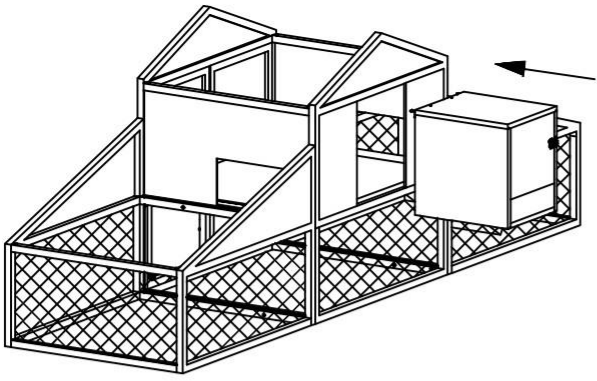

AC x4

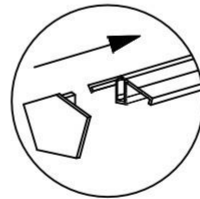
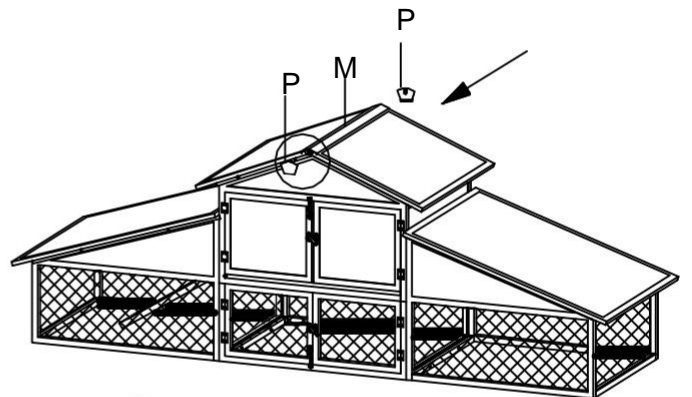
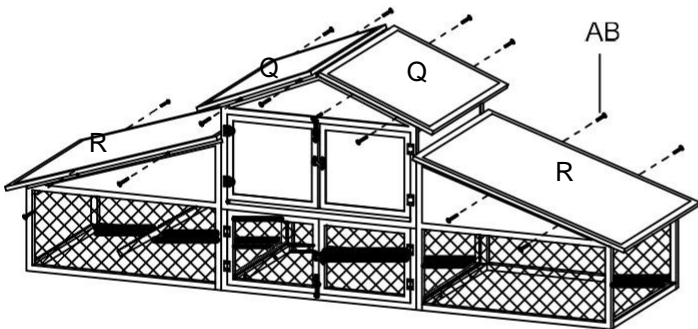

AB x16

