

METALCRAFT

Monteringsanvisning

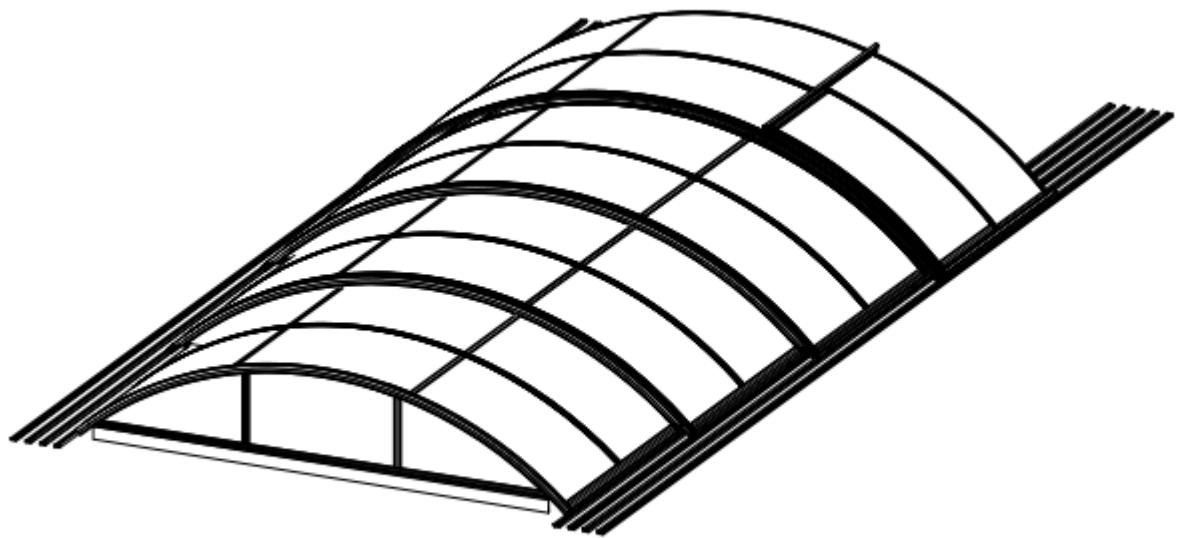

MODELL 142-2-6

STORLEK (L x B x H): 516 x 1 062 x 117 cm

LÄS IGENOM NOGGRANT FÖRE MONTERING

Monterings- och underhållsanvisningar

1. För din säkerhet, rekommenderar vi att pooltaket monteras av minst tre personer.
2. Några delar har vassa metallkanter. Var försiktig när du hanterar metall-
delar. Bär handskar, skor och skyddsglasögon under monteringen.
3. **KLÄTTRA INTE** och **STÅ INTE** på pooltaket. Luta inga tunga föremål mot
pooltaket.
4. Håll pooltaket fritt från snö, smuts och löv. Om du låter snö ansamlas på
pooltaket kan skador uppstå.
5. När pooltaket behöver rengöras, använd en mild blandning av diskmedel och vatten.
Skölj med kallt, rent vatten.
Använd inte aceton, rengöringsmedel innehållande slipmedel eller andra starka
rengöringsmedel vid rengöring av pooltakets paneler.

Verktyg som ingår:

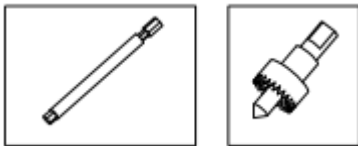



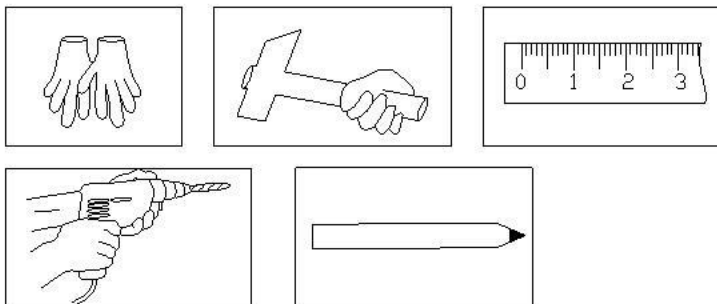



















Verktyg som behövs vid monteringen (ingår inte)

















Monteras av minst tre personer



142-2-6 (aluminiumlåda)

DEL	NR.	ST.
	L01A	8
	01-L02A	1
	01-L02B	1
	02-L02A	2
	02-L02B	1
	03-L02A	2
	03-L02B	1
	04-L02A	1
	04-L02B	1
	01-L02G	2
	01-L02H	2
	L04A	16
	L05A	2
	L06A	16
	L06B	8
	L08A	1
	L08B	1
	L09A	2
	L11	32
	L12	16
	L13	4
	K1-1	1
	K4-1	1



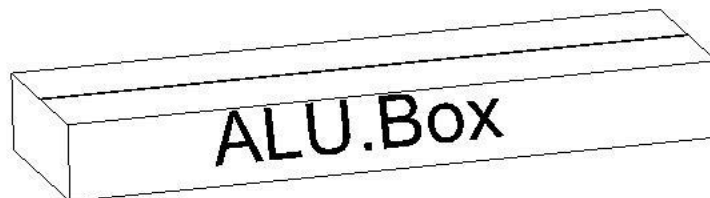





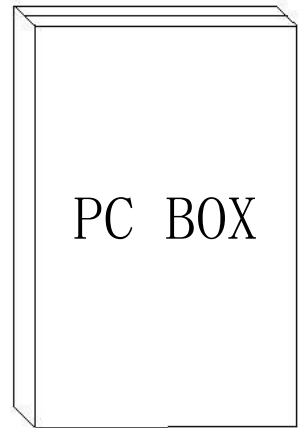

DEL	NR.	ST.
	W01	4
	W02	1
	CX	6
	J01	158
	J02	104
	J03	17 M
	HL	24
	HL2	8
	S01 M6X35	24
	M01	32
	M02	24
	Z01 M6X60	160
	Z02 M4.2X16	202
	Z03 M4.2X25	12
	Z04 Ø6X16	8















142-2-6 (papplåda)

DEL	NR.	ST.
<input type="checkbox"/>	Y1	4
<input type="checkbox"/>	Y2	6
<input type="checkbox"/>	Y3	6
<input type="checkbox"/>	Y4	6
<input type="checkbox"/>	Y9	1
<input type="checkbox"/>	Y10	4



DEL	NR.	ST.
	L01A	2
	01-L02A	1
	01-L02B	1
	01-L02G	2
	01-L02H	2
	L04A	4
	L05A	2
	L08A	1
	L09A	2
	L11	8
	K1-1	1

DEL	NR.	ST.
	W01	4
	W02	1
	CX	1
	J01	26
	HL	6
	HL2	8
	S01 M6X35	6
	M01	14
	M02	6
	Z01 M6X60	20
	Z02 M4.2X16	53
	Z03 M4.2X25	2
	Z04 Ø6X16	8







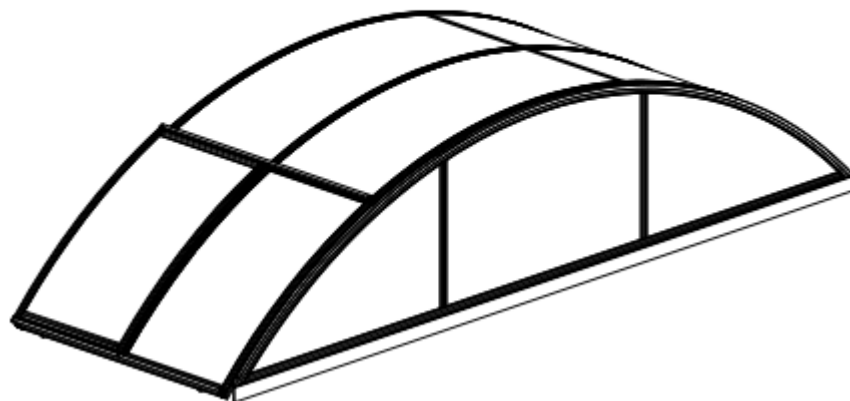

DEL	NR.	ST.
	Y1	4
	Y9	1
	Y10	1

DEL	NR.	ST.
	J03	5,72 M

Montering av K1

K1



PART	NO	QTY
	L01A	2
	K1-1	1
	L08A	1
	HL	6
	M02	6
	S01 M6X35	6
	M01	6
	Z01 Ø6X60	4
	Z02 M4.2X16	5

Montera hjulen på L01A (3 st.) med S01 & M01.

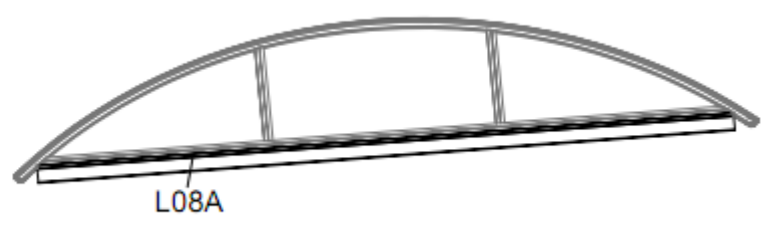
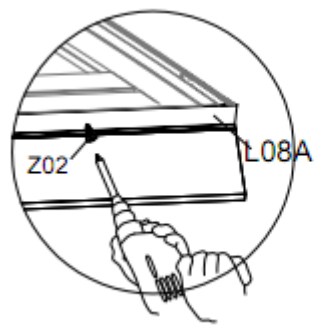
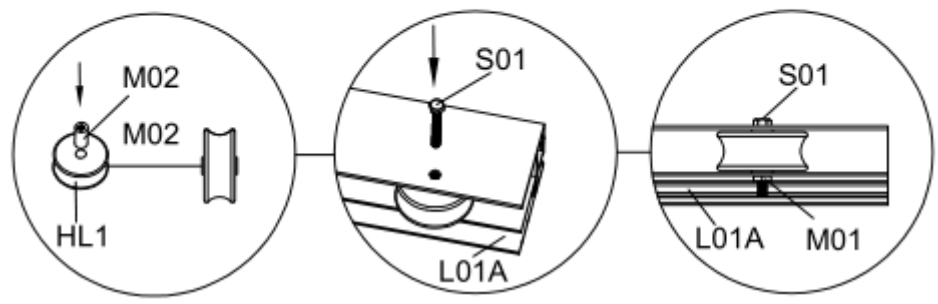
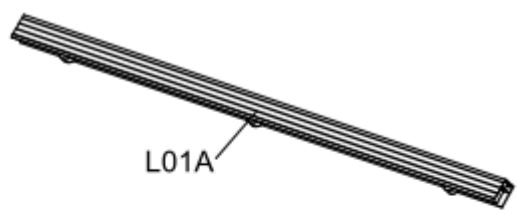



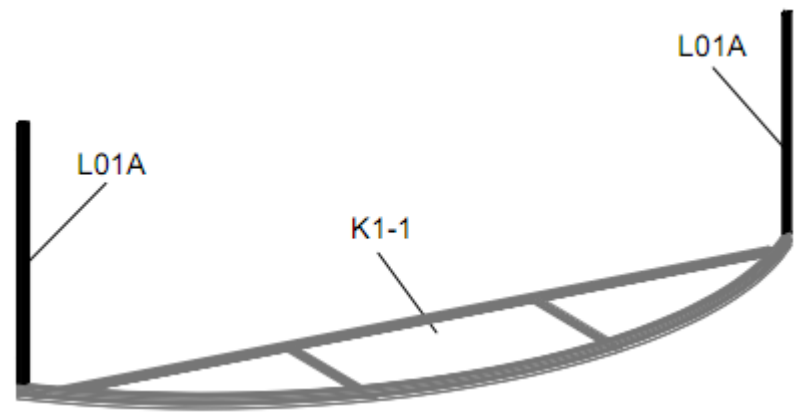

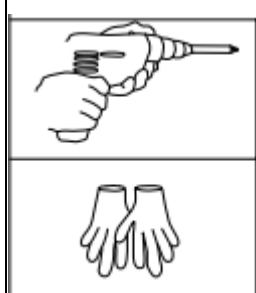
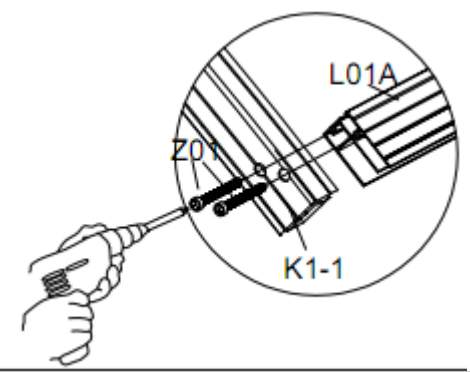

Montera L08A på K1-1 med Z02.



Montera L01A x 2 st. på K1-1 med Z01, se bilden ovan.



PART	NO	QTY
	L04A	2
	01-L02B	1
	L11	4
	Y1	2
	Z02 M4.2X16	16
	Z01 Ø6X60	4

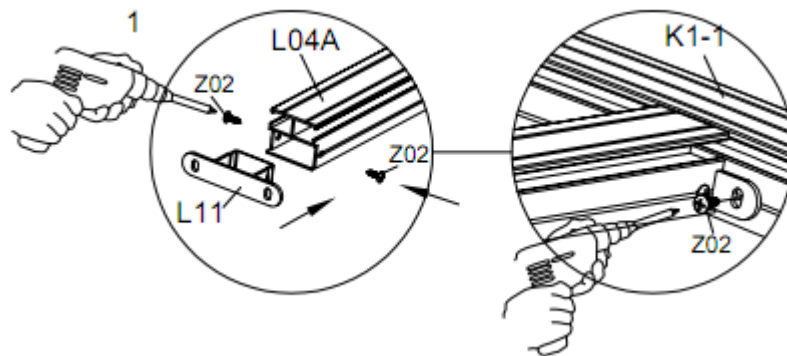
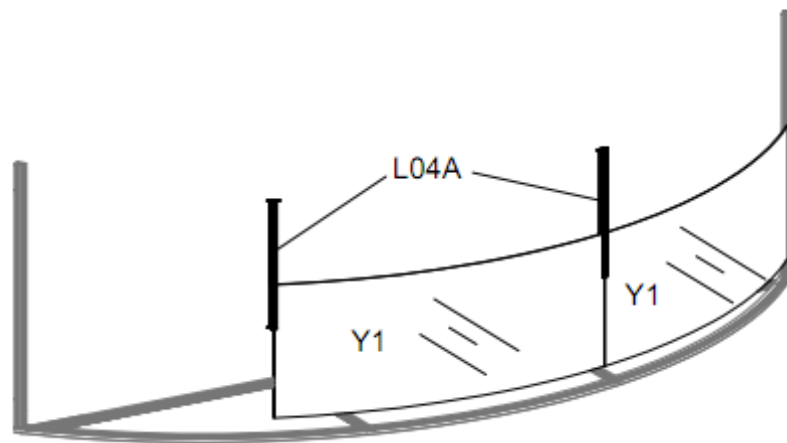

1. För in L11 i L04A, se bilden, och fixera den med Z02;
2. Montera L04A på K1-1, se bilden, med Z02.

Viktigt! Y1 måste placeras i kanalen på L04A & L01 A samtidigt.
Se till att alla paneler sitter rätt innan du drar åt Z02 ordentligt.

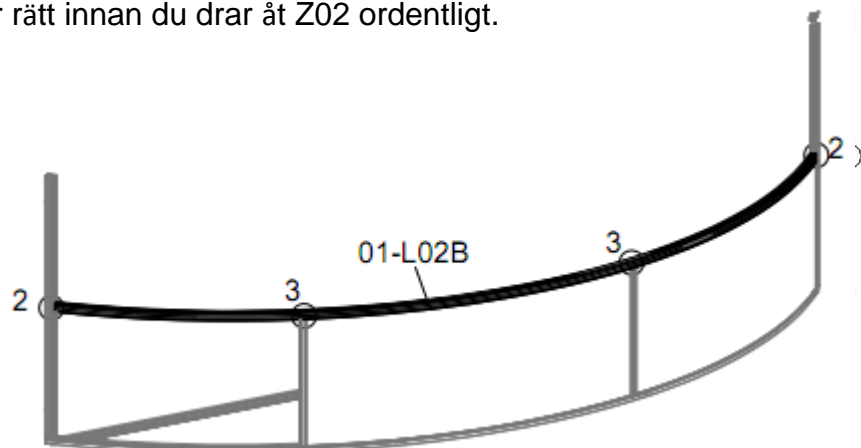

Montera ihop 01-L02B med L01A och L04A, använd Z01 & Z02.

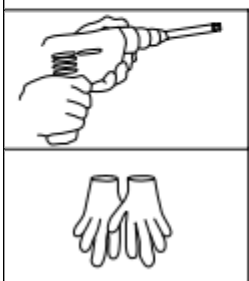
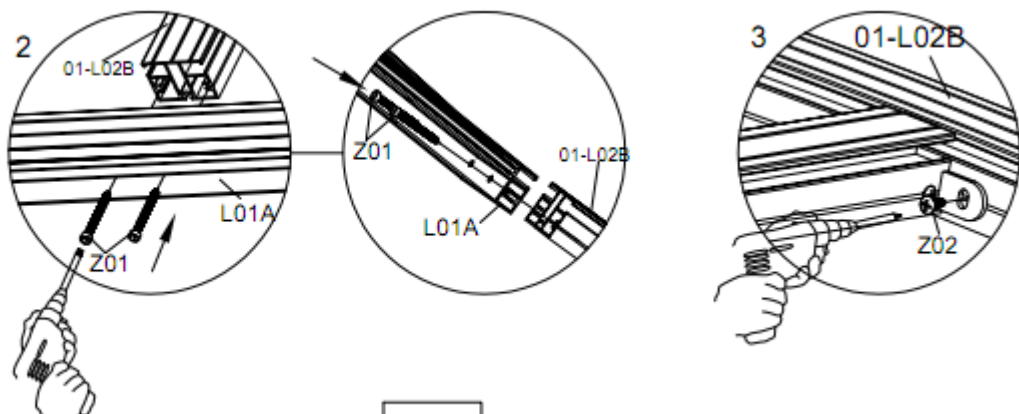

PART	NO	QTY
	01-L02A	1
	L04A	2
	L11	4
	Y1	2
	Y9	1
	Z02 M4.2X16	16
	Z01 Ø6X60	4

Viktigt! Y1 & Y9 måste placeras i kanalen på L04A/L01A samtidigt.
Se till att alla paneler sitter rätt innan du drar åt Z02 ordentligt.

DEL	NR.	ST.
	J03	5,72 M

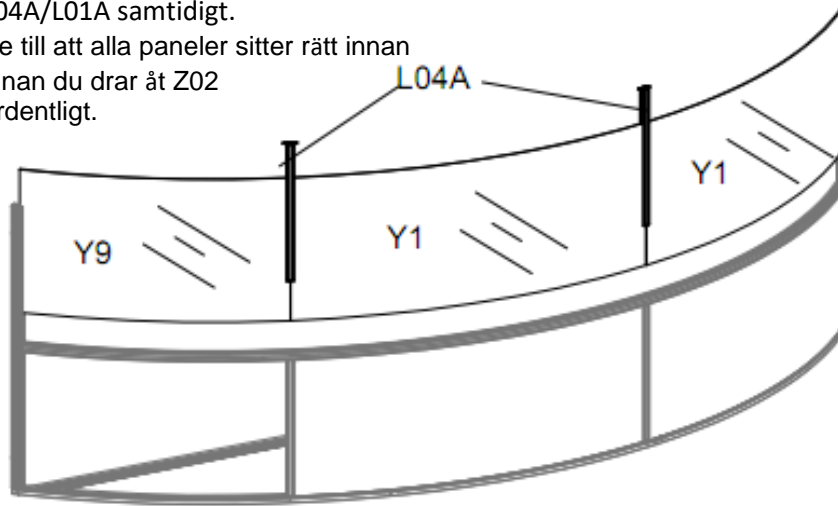

Montera L04A på 01-L02B, se bilden, med Z02.

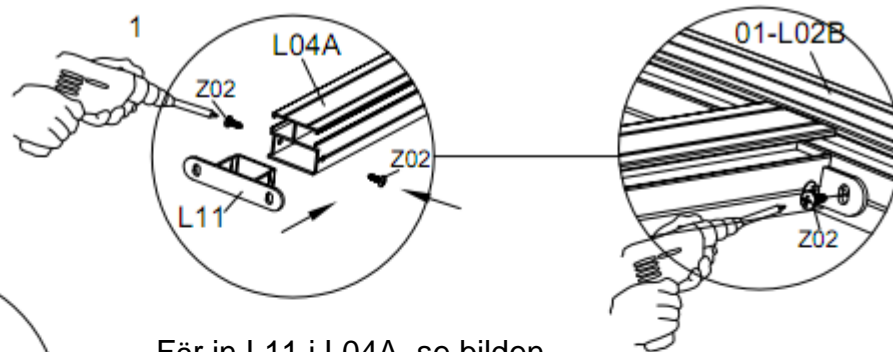

För in L11 i L04A, se bilden, och fixera den på L04A med Z02;

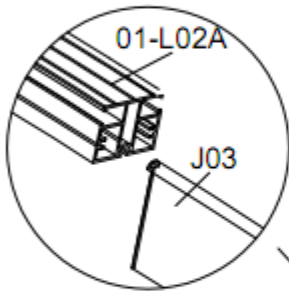

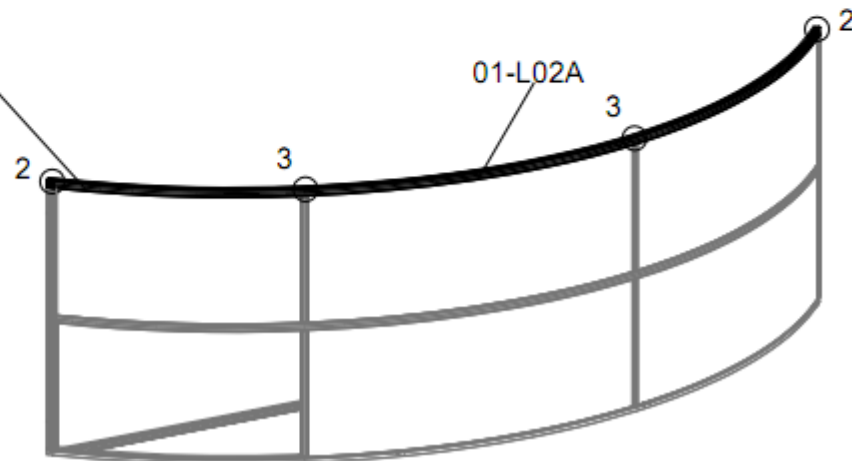

För in gummit J03 i kanalen på 01-L02A.



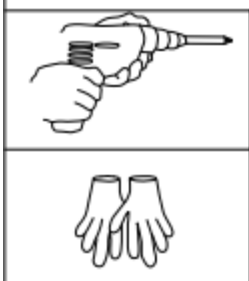
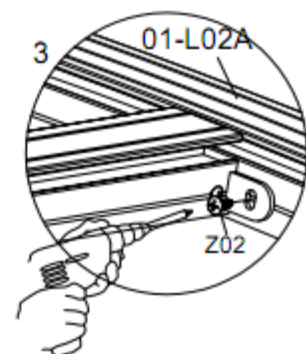
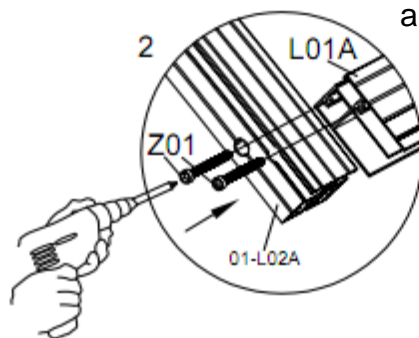

Montera ihop 01-L02A med L01A och L04A, använd Z01 & Z02.

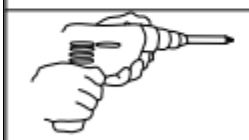
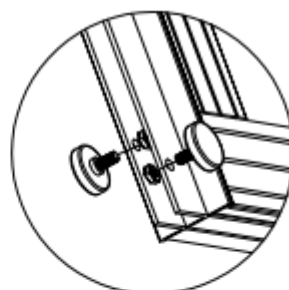
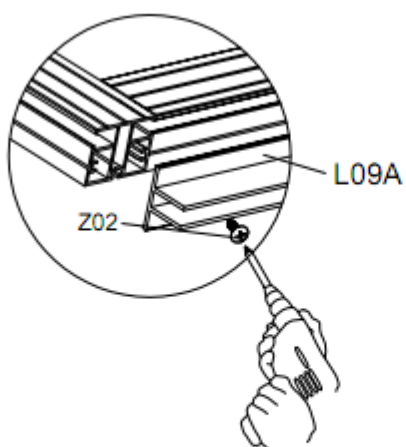
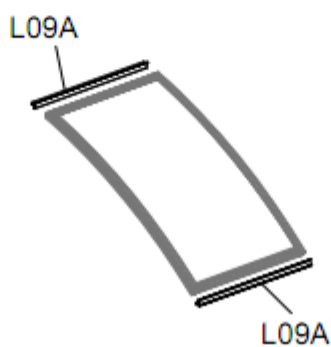
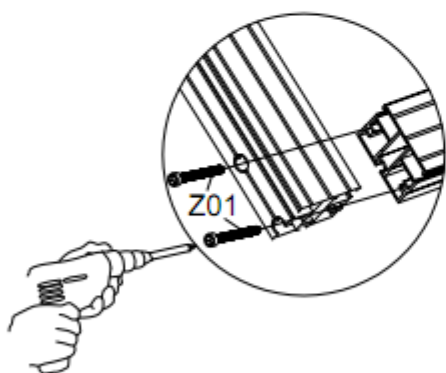
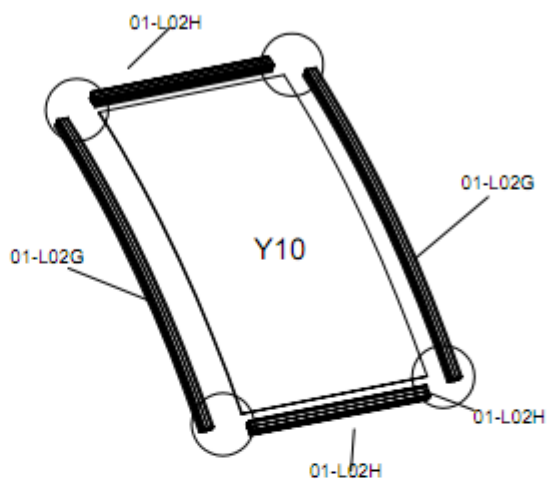

PART	NO	QTY
	01-L02G	2
	01-L02H	2
	L09A	2
	HL2	8
	Y10	1
	Z02 M4.2X16	8
	Z01 Ø6X60	8
	M01	8

Montering av fönster





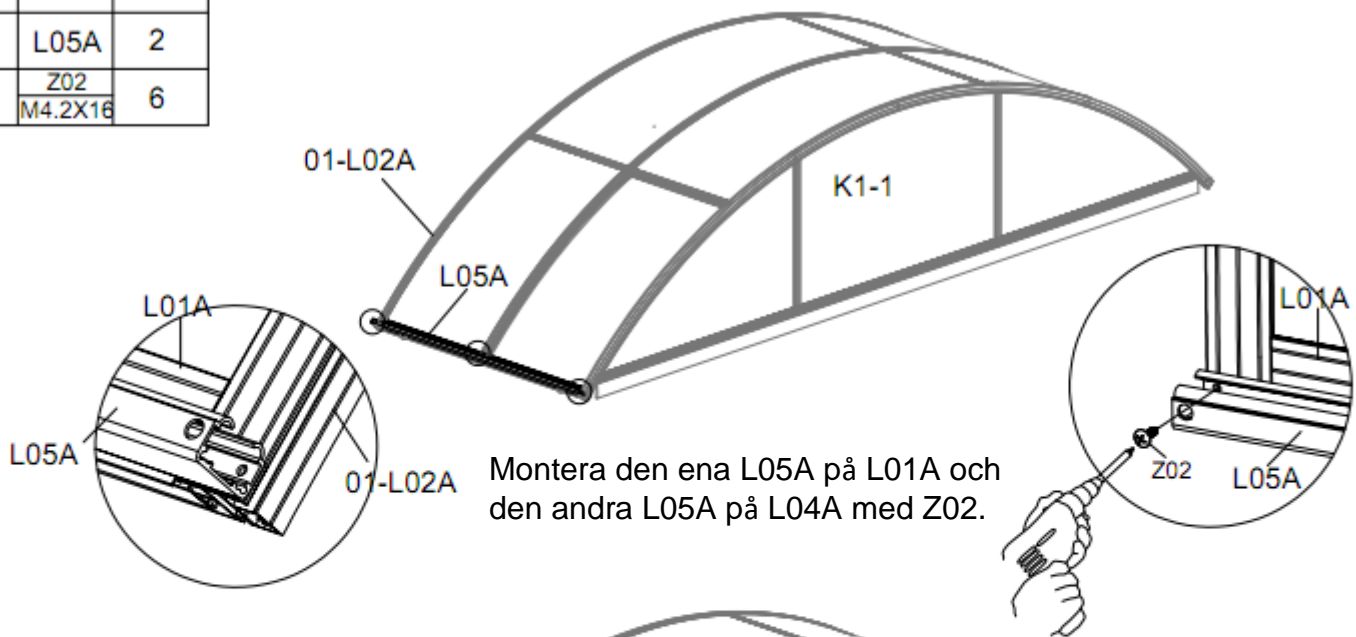

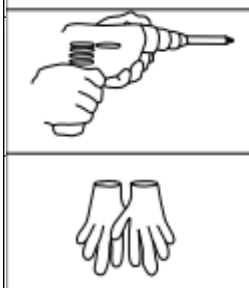
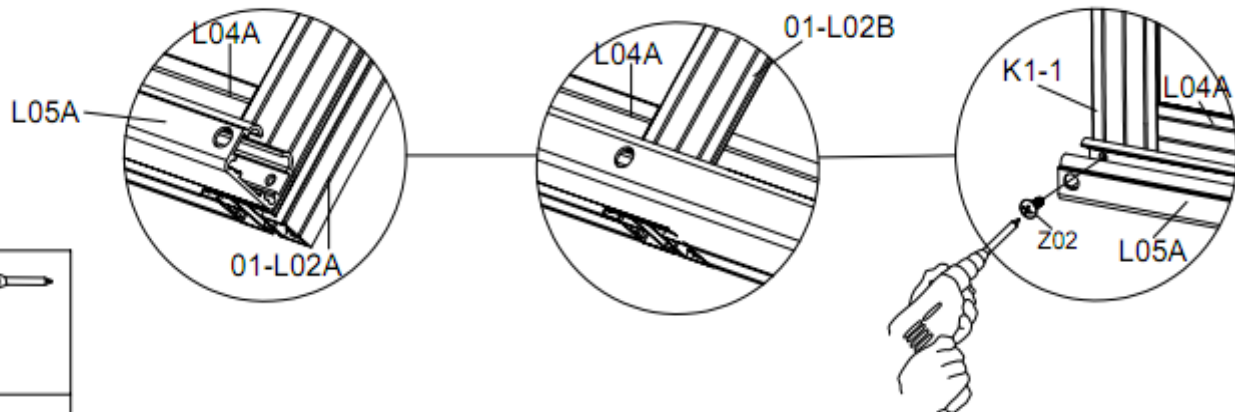
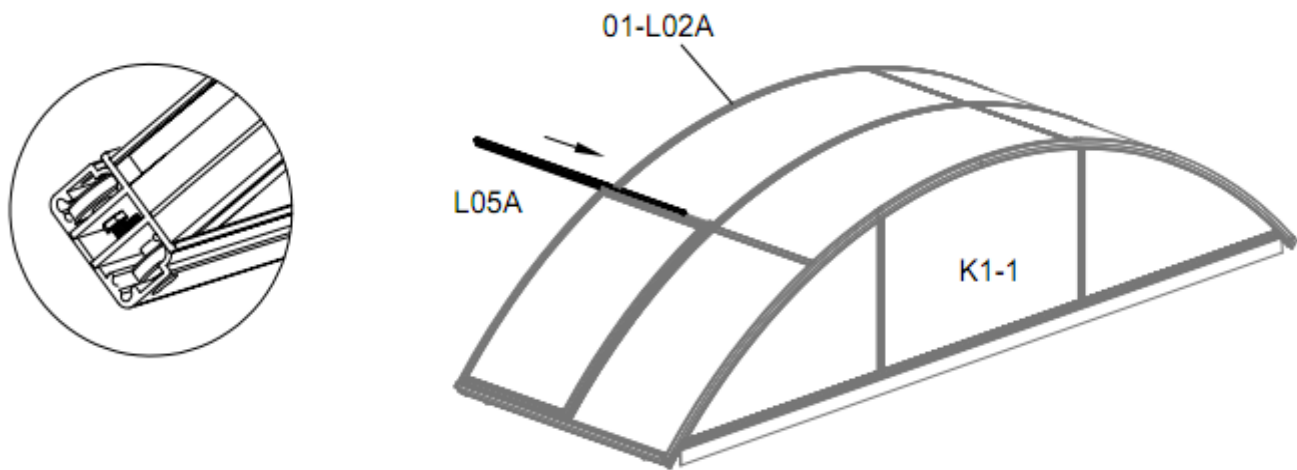
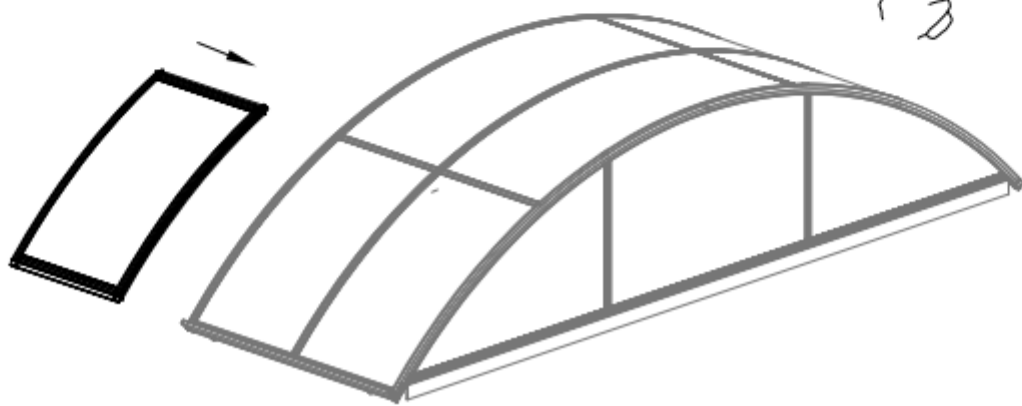

PART	NO	QTY
	L05A	2
	Z02 M4.2X16	6



Montera den ena L05A på L01A och den andra L05A på L04A med Z02.



PART	NO	QTY
	CX	1
	J01	26
	Z02 M4.2X16	2
	Z03 M4.2X25	2
	Z04 Ø6X16	8
	W01	4
	W02	1

Montera W01 (4 st.) på båda ändarna av L05A med Z04.

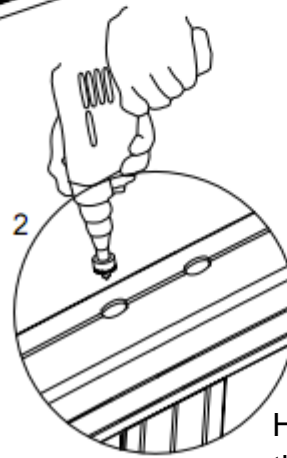
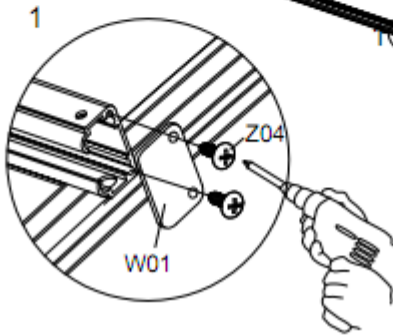
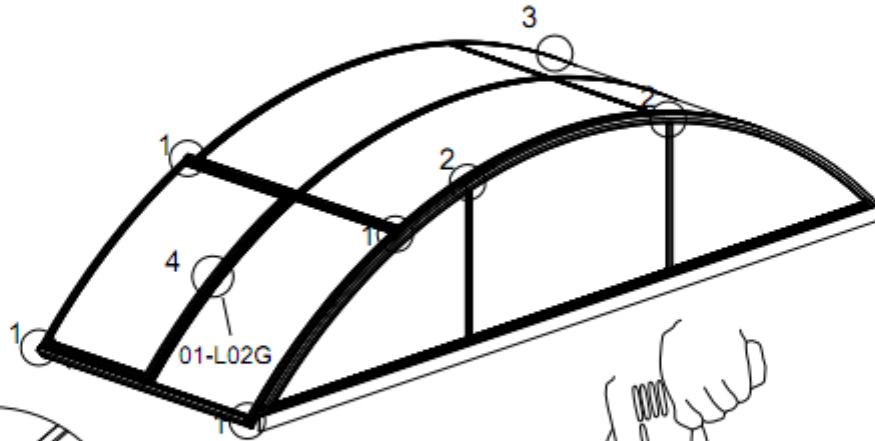

Hålen måste utvidgas till diameter 14 mm, använd en brotsch och en elskruvdragare.

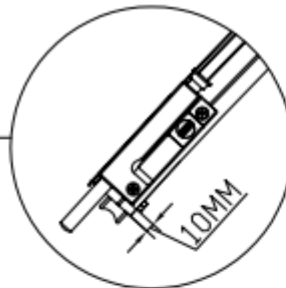
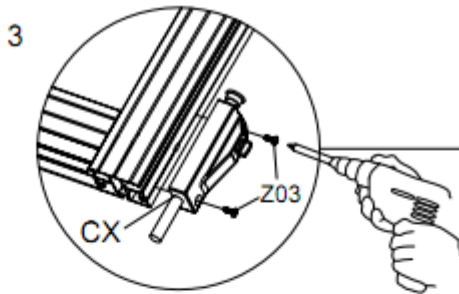

Montera CX på 01-L02A, 10 mm från nederkanten, med Z03.

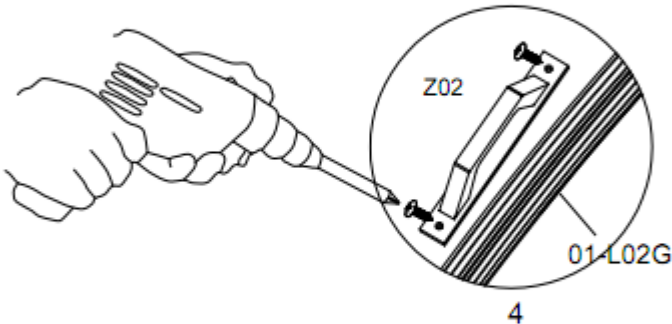



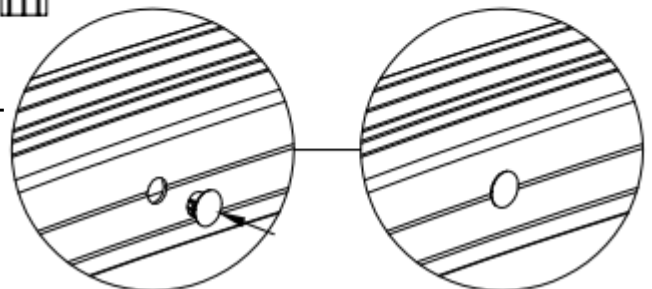



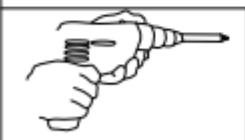







Sätt på handtaget W02 på fönsterprofilen 01-L02G med Z02.





Dölj alla hål med J01



DEL	NR.	ST.
	L01A	2
	02-L02A	2
	02-L02B	1
	L04A	4
	L11	8





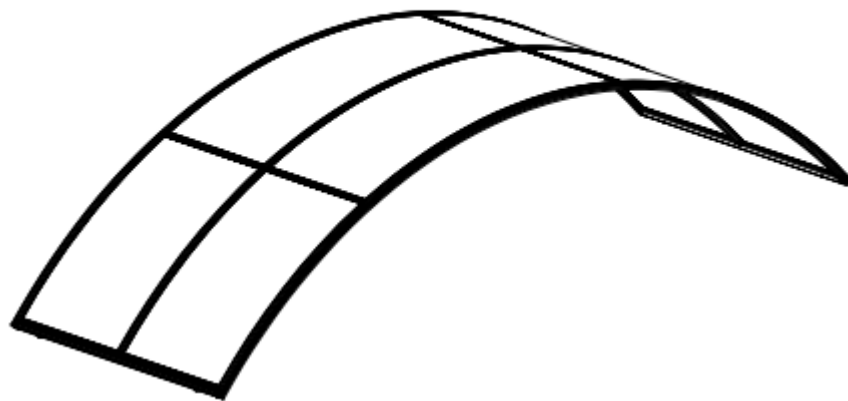

DEL	NR.	ST.
	CX	2
	J01	8
	HL	6
	S01 M6X35	6
	M01	6
	M02	6
	Z01 M6X60	12
	Z02 M4.2X16	32
	Z03 M4.2X25	4

DEL	NR.	ST.
	Y2	6

DEL	NR.	ST.
	J03	5,39 M

K2







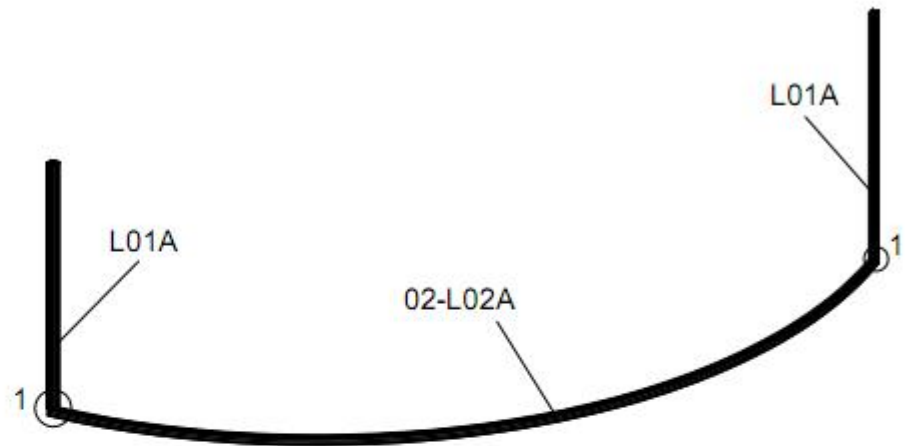
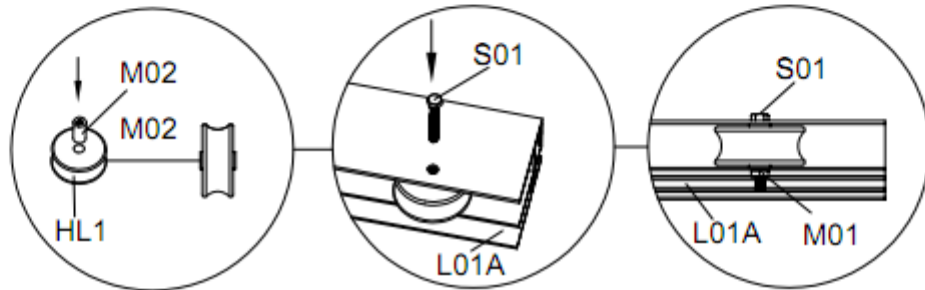
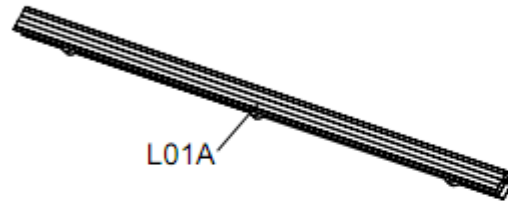

PART	NO	QTY
	L01A	2
	02-L02A	1
	HL	6
	M02	6
	S01 M6X35	6
	M01	6
	Z01 M6X60	4

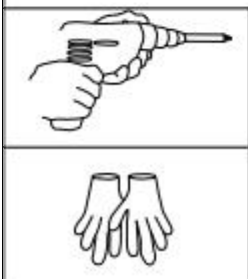
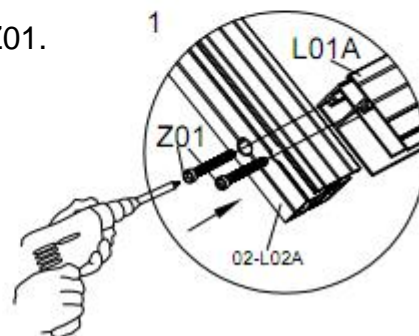
Montera hjulen på L01A (3 st.)
med S01 & M01.



Montera L01A x 2 st. på 02-L02A med Z01.







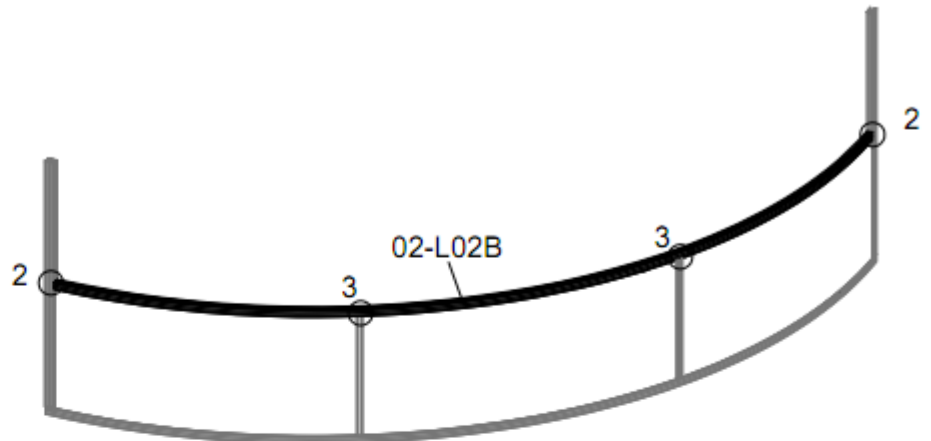
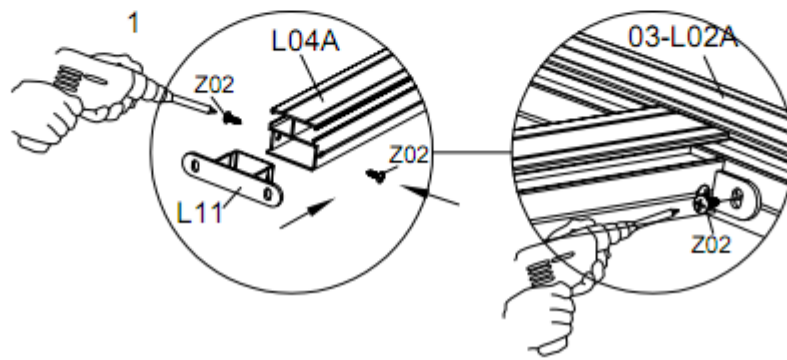
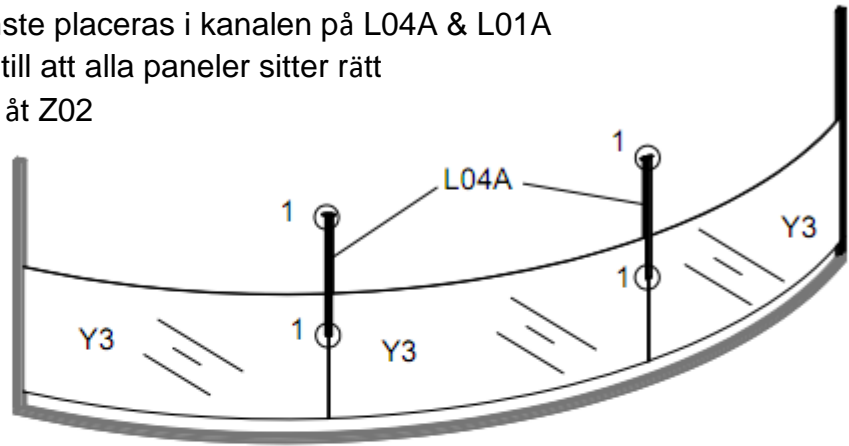

PART	NO	QTY
	L04A	2
	03-L02B	1
	L11	4
	Y3	3
	Z02 M4.2X16	16
	Z01 M6X60	4

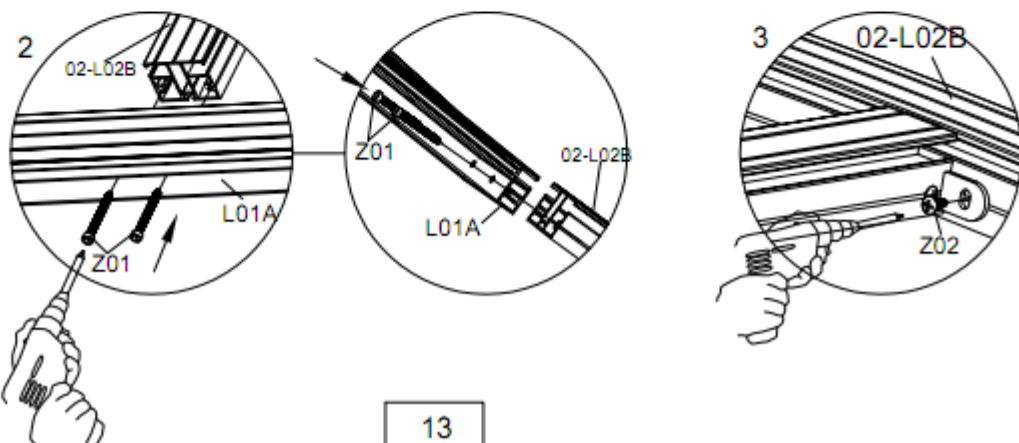
1. För in L11 i L04A, se bilden, och fixera den med Z02;
 2. Montera L04A på 02- L02A, se bilden, med Z02.
- Viktigt! Y2 måste placeras i kanalen på L04A & L01A samtidigt. Se till att alla paneler sitter rätt innan du drar åt Z02 ordentligt.





Montera ihop 02-L02B med L01A och L04A, använd Z01 & Z02.

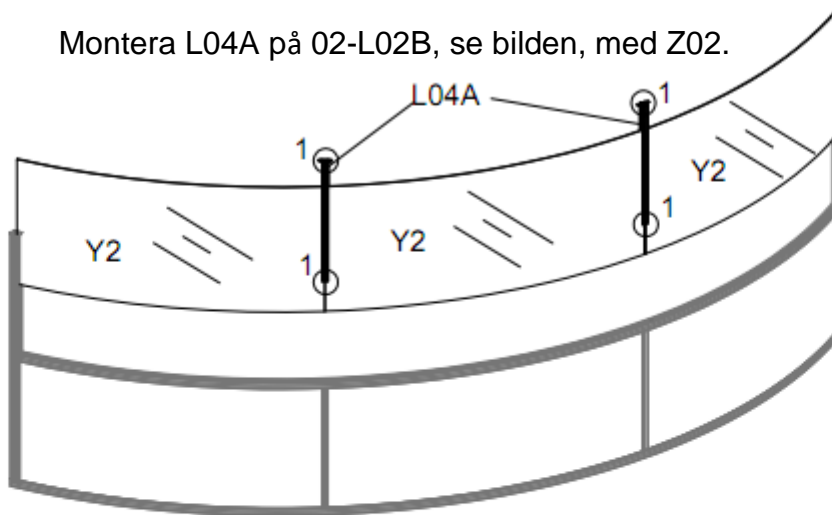

PART	NO	QTY
	02-L02A	1
	L04A	2
	L11	4
	Y2	3
	Z02 M4.2X16	16
	Z01 M6X60	4

Montera L04A på 02-L02B, se bilden, med Z02.



PART	NO	QTY
	J03	5.39M

Viktigt!
Y2 måste placeras i kanalen på L04A/L01A samtidigt. Se till att alla panelerna sitter på rätt position innan du drar åt Z02 ordentligt.

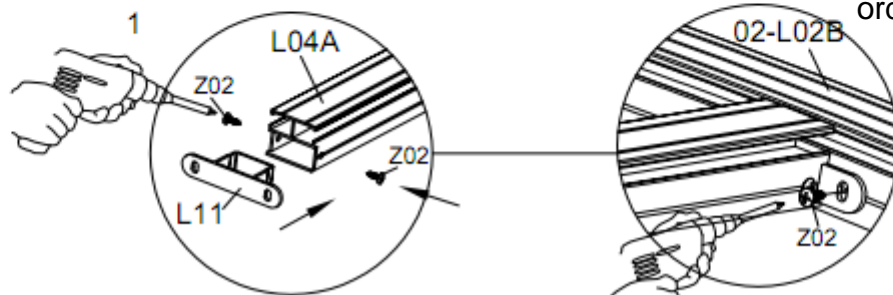



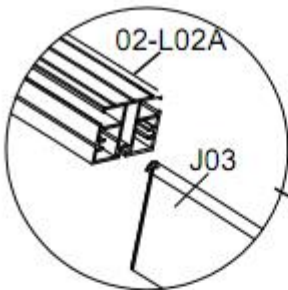

För in L11 i L04A, se bilden, och fixera den på L04A med Z02;

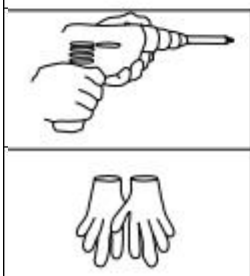
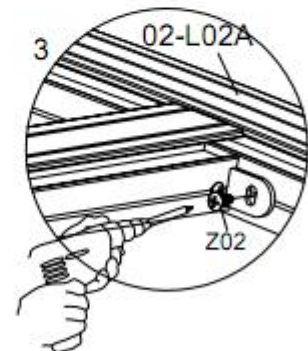
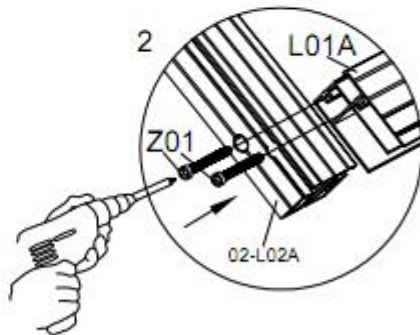
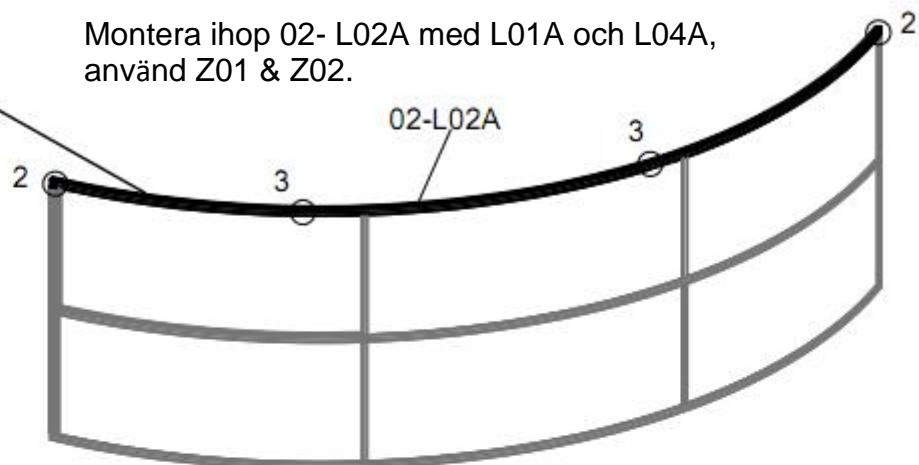

För in gummit J03 i kanalen på 02-L02A.

Montera ihop 02-L02A med L01A och L04A, använd Z01 & Z02.



PART	NO	QTY
	CX	2
	J01	8
	Z03 M4.2X25	4

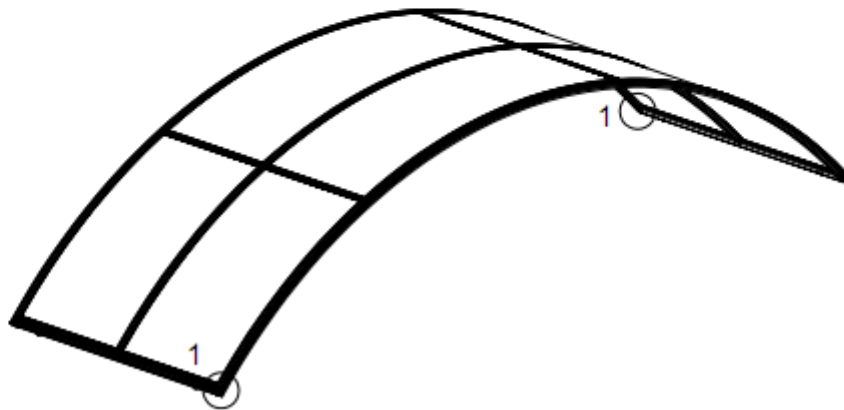



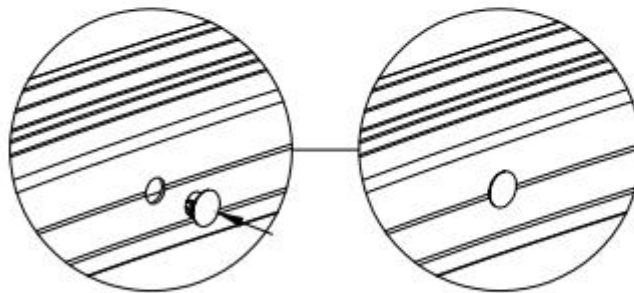
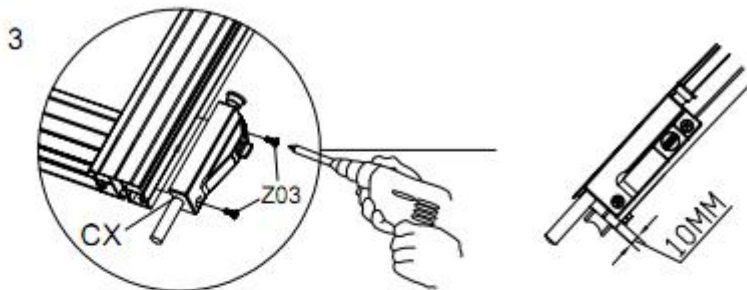



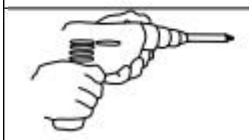







Montera CX (2 st.) på 02-L02A, 10 mm från nederkanten, med Z03.





Dölj alla hål med J01



DEL	NR.	ST.
	L01A	2
	03-L02A	2
	03-L02B	1
	L04A	4
	L11	8





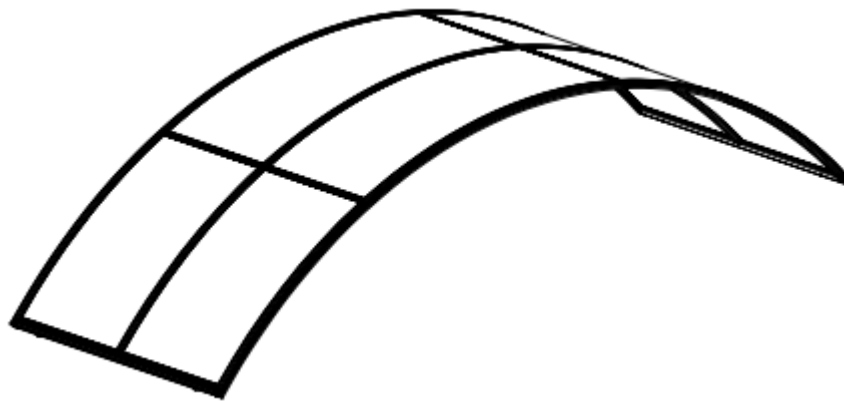

DEL	NR.	ST.
	CX	2
	J01	8
	HL	6
	S01 M6X35	6
	M01	6
	M02	6
	Z01 M6X60	12
	Z02 M4.2X16	32
	Z03 M4.2X25	4

DEL	NR.	ST.
	Y3	6

DEL	NR.	ST.
	J03	5,07 M

K3







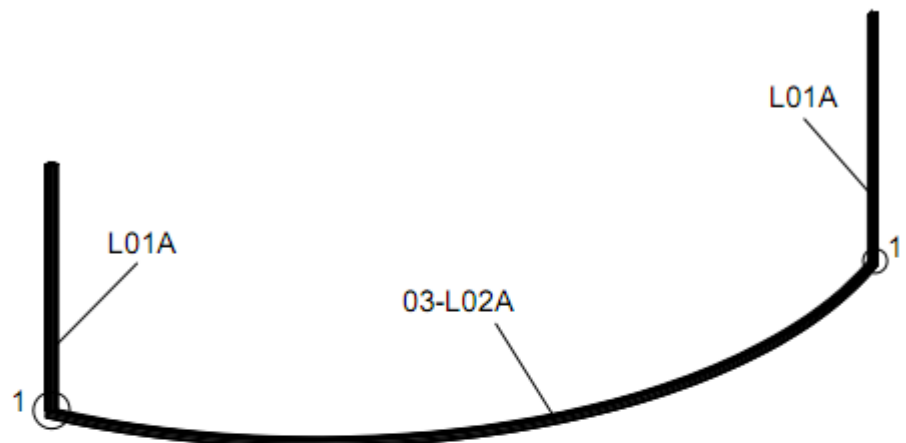
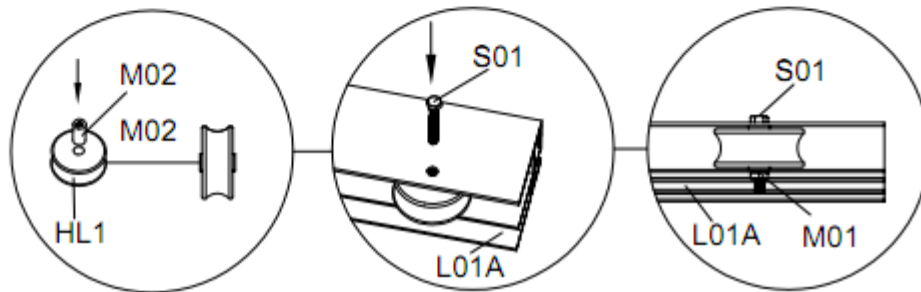
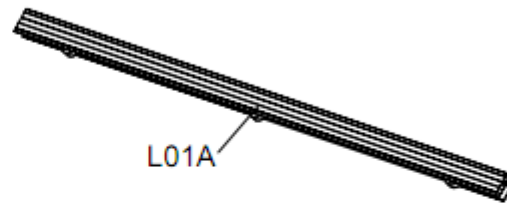

PART	NO	QTY
	L01A	2
	03-L02A	1
	HL	6
	M02	6
	S01	6
	M6X35	
	M01	6
	Z01	4
	M6X60	

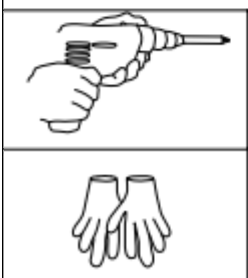
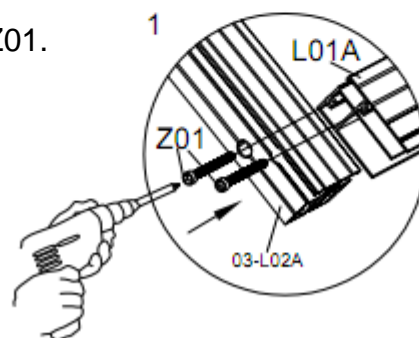
Montera hjulen på L01A (3 st.)
med S01 & M01.



Montera L01A x 2 st. på 03-L02A med Z01.







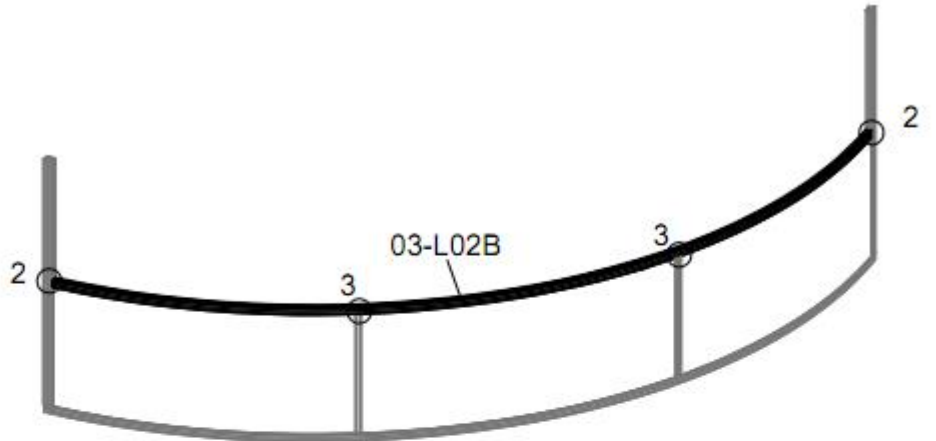
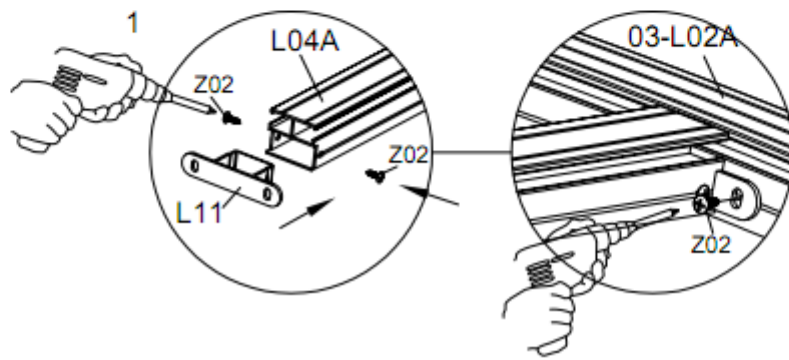
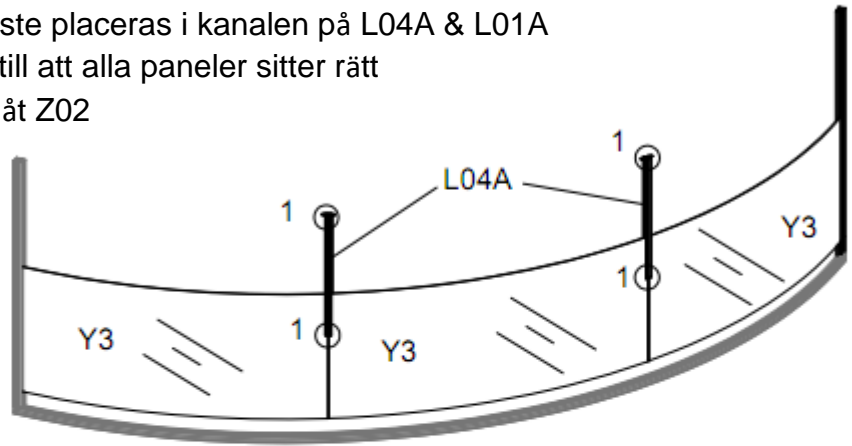

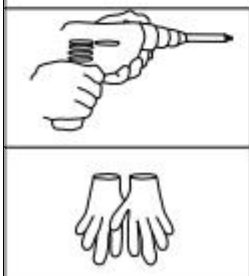
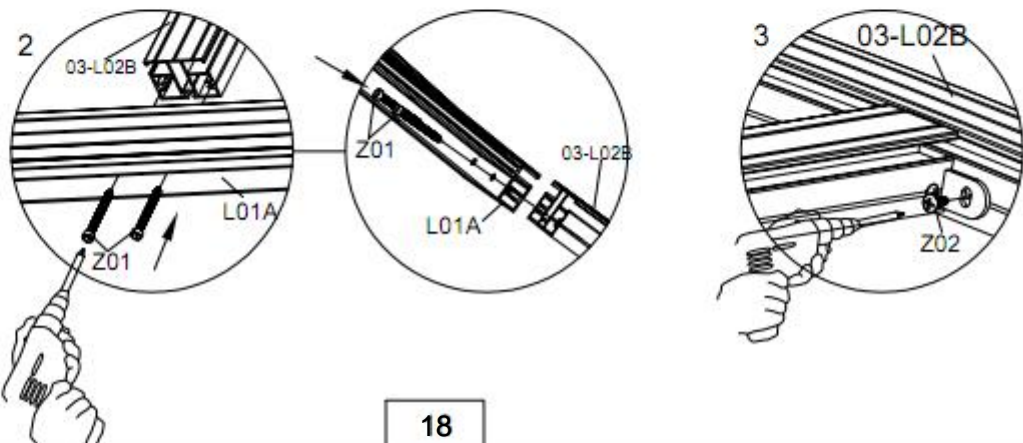

PART	NO	QTY
	L04A	2
	03-L02B	1
	L11	4
	Y3	3
	Z02	16
	M4.2X16	
	Z01	4
	M6X60	

1. För in L11 i L04A, se bilden, och fixera den med Z02;
 2. Montera L04A på 03-L02A, se bilden, med Z02.
- Viktigt! Y3 måste placeras i kanalen på L04A & L01A samtidigt. Se till att alla paneler sitter rätt innan du drar åt Z02 ordentligt.





Montera ihop 03-L02B med L01A och L04A, använd Z01 & Z02.

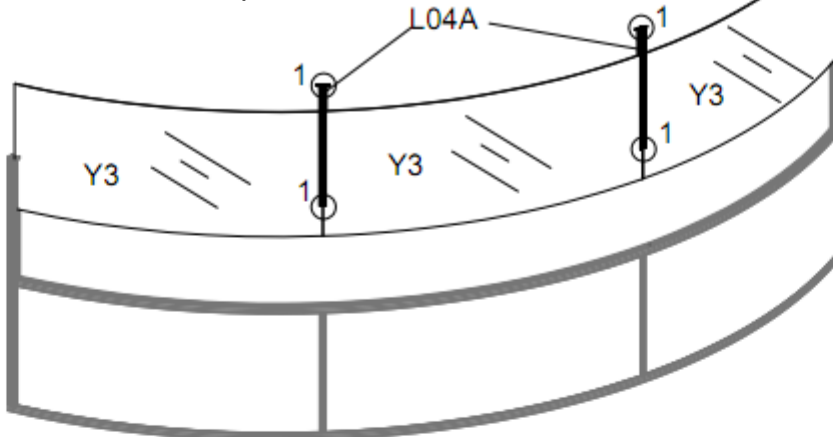

PART	NO	QTY
	03-L02A	1
	L04A	2
	L11	4
	Y3	3
	Z02	16
	Z01 M6X60	4
	J01	8

Montera L04A på 03-L02B, se bilden, med Z02.



PART	NO	QTY
	J03	5.07M

Viktigt!
Y3 måste placeras i kanalen på L04A/L01A samtidigt. Se till att alla panelerna sitter på rätt position innan du drar åt Z02 ordentligt.

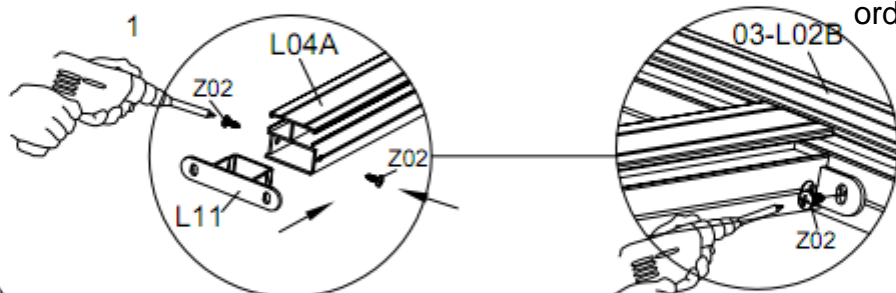

För in L11 i L04A, se bilden, och fixera den på L04A med Z02;

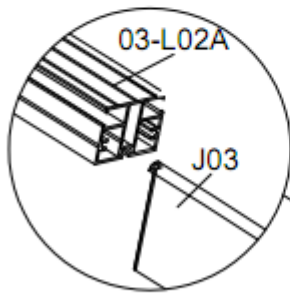

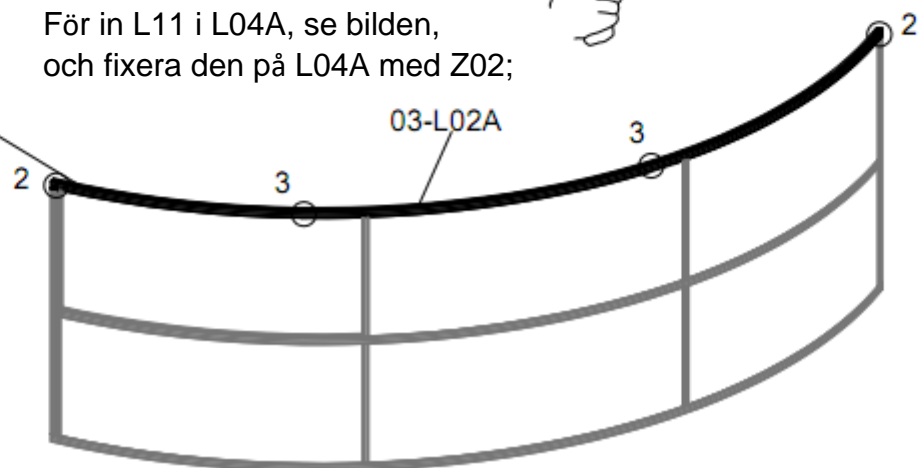

För in gummit J03 i kanalen på 03-L02A.

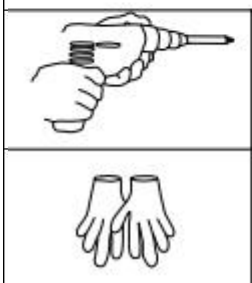
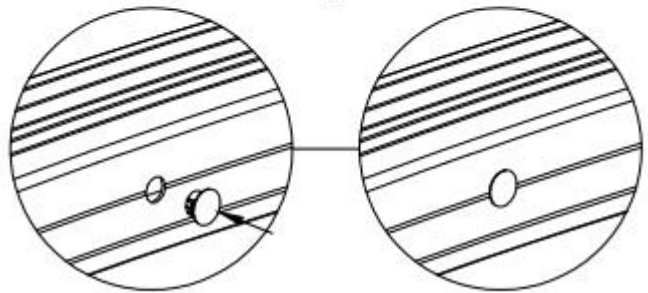
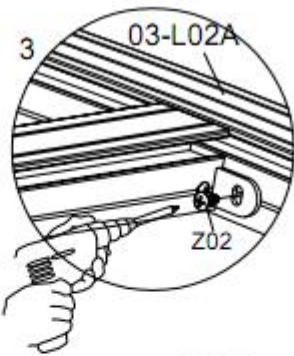
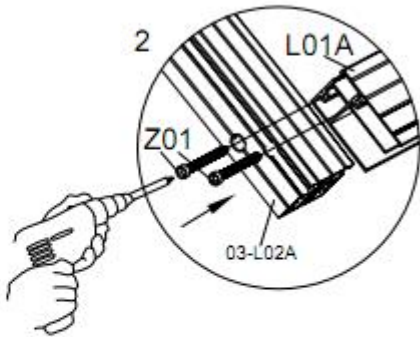

Montera ihop 03-L02A med L01A och L04A, använd Z01 & Z02.



PART	NO	QTY
	CX	2
	J01	8
	Z03 M4.2X25	4

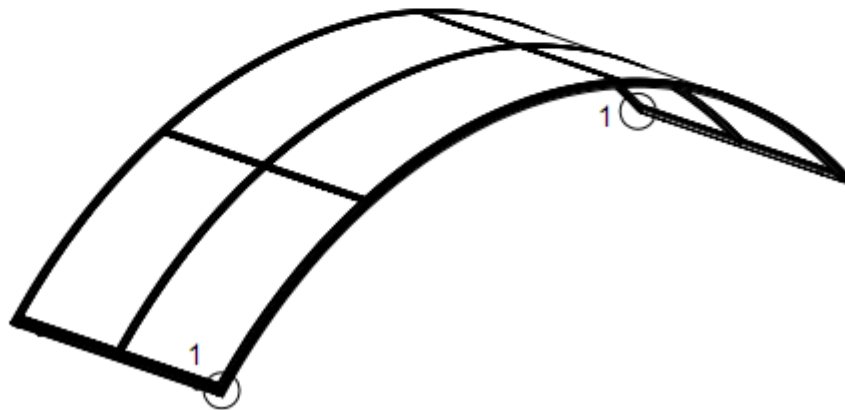



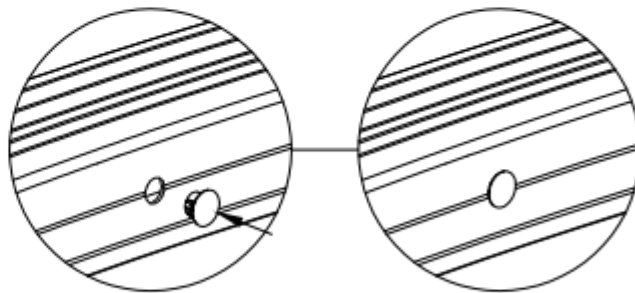
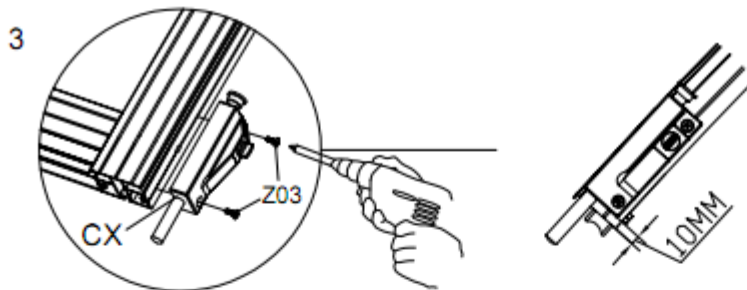



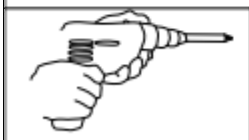









Montera CX (2 st.) på 03-L02A, 10 mm från nederkanten, med Z03.



Dölj alla hål med J01











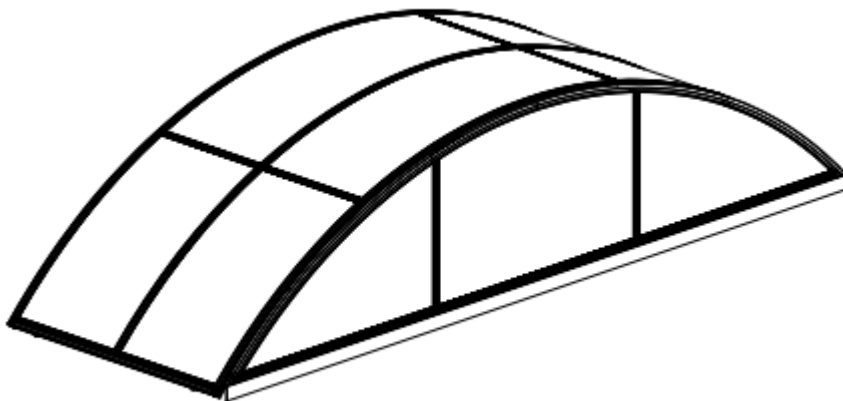

DEL	NR.	ST.
	L01A	2
	04-L02A	1
	04-L02B	1
	L04A	4
	L08B	1
	L11	8
	K5-1	1

DEL	NR.	ST.
	CX	1
	J01	12
	HL	6
	S01 M6X35	6
	M01	6
	M02	6
	Z01 M6X60	12
	Z02 M4X16	37
	Z03 M4.2X25	2

DEL	NR.	ST.
	Y4	6

K4



PART	NO	QTY
	L01A	2
	K4-1	1
	L08B	1
	HL	6
	M02	6
	S01 M6X35	6
	M01	6
	Z01 Ø6X60	4
	Z02 M4.2X16	5

Montera hjulen på L01A (3 st.)
med S01 & M01.

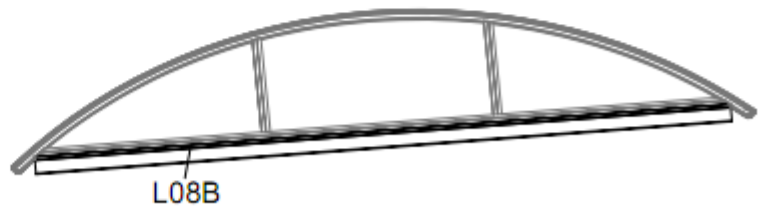
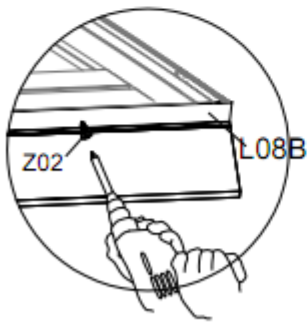
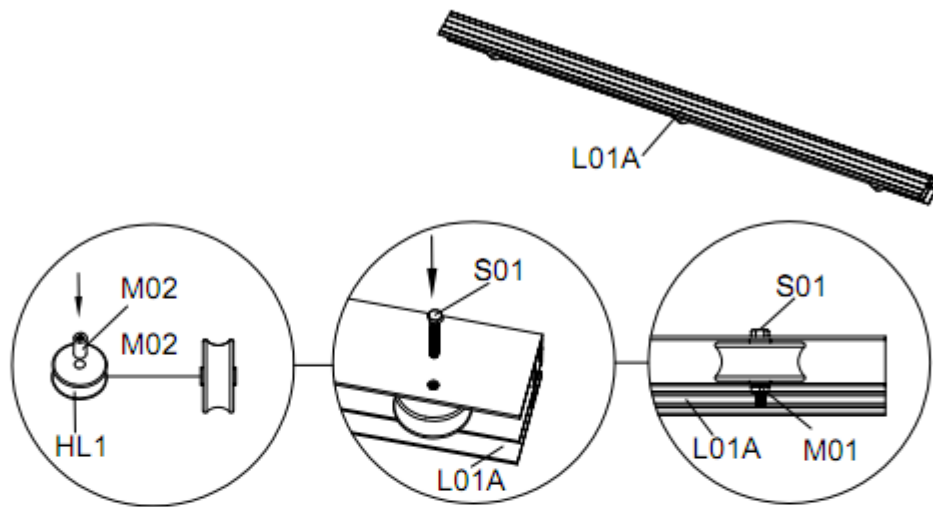



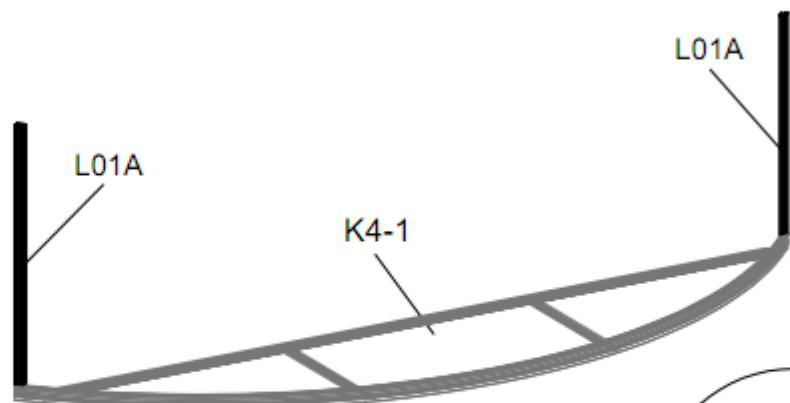

Montera L08B på K4-1 med Z02.

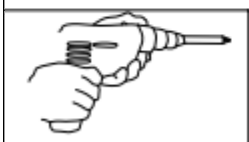
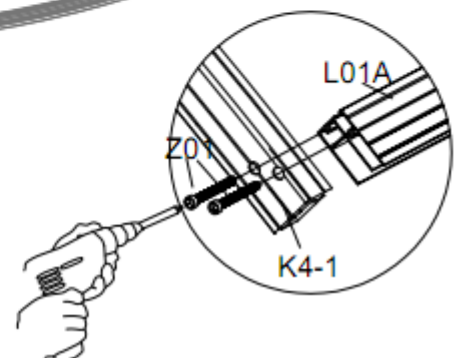

Montera L01A x 2 st. på K4-1 med Z01.



PART	NO	QTY
	L04A	2
	04-L02B	1
	L11	4
	Y4	3
	Z02	16
	M4X16	
	Z01	4
	M6X60	

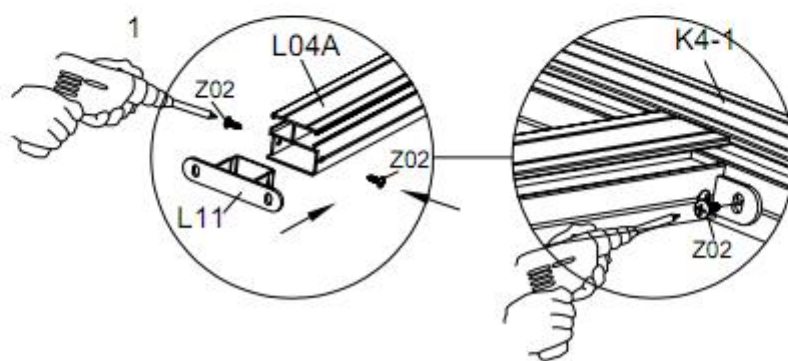
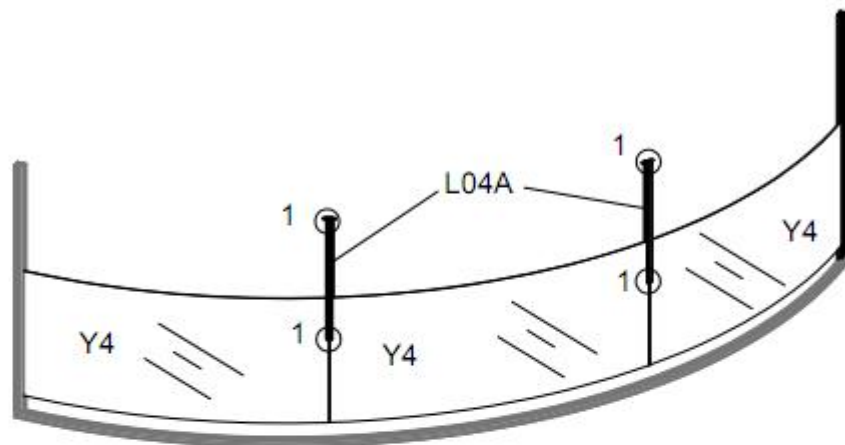



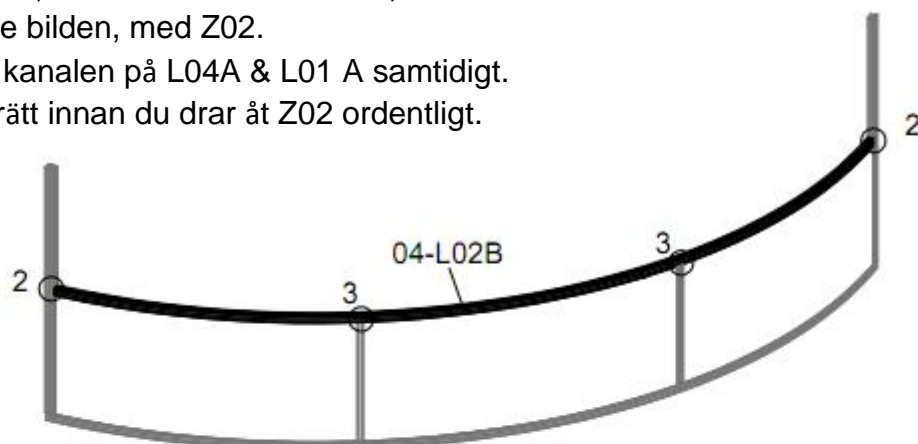

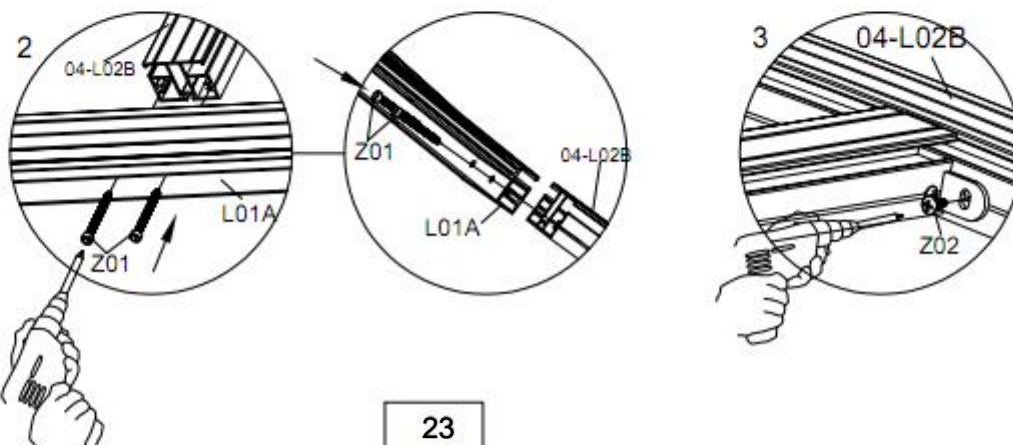

1. För in L11 i L04A, se bilden, och fixera den med Z02;
 2. Montera L04A på K4-1, se bilden, med Z02.
- Viktigt! Y4 måste placeras i kanalen på L04A & L01 A samtidigt.
Se till att alla paneler sitter rätt innan du drar åt Z02 ordentligt.



Montera ihop 04-L02B med L01A och L04A, använd Z01 & Z02.



PART	NO	QTY
	04-L02A	1
	L04A	2
	L11	4
	Y4	3
	Z02 M4X16	16
	Z01 M6X60	4

Montera L04A på 04-L02B, se bilden, med Z02.

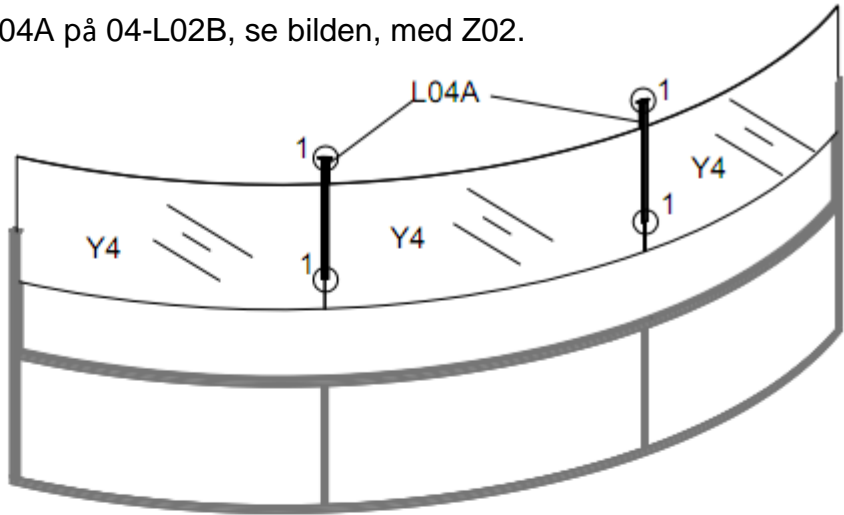

Viktigt!

Y4 måste placeras i kanalen

på L04A/L01A samtidigt.

Se till att alla panelerna sitter på rätt position innan du drar åt Z02 ordentligt.

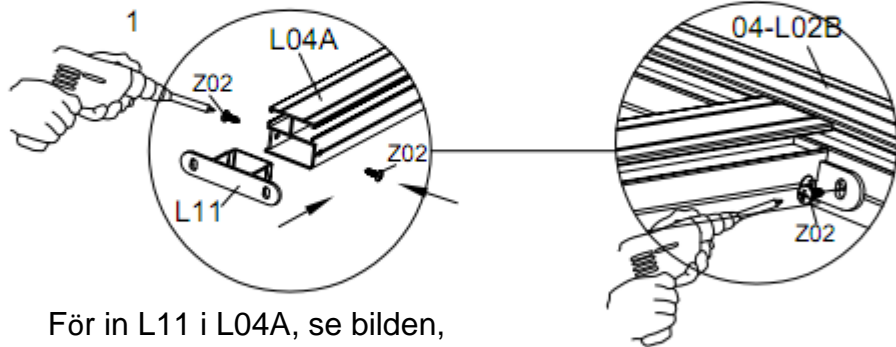

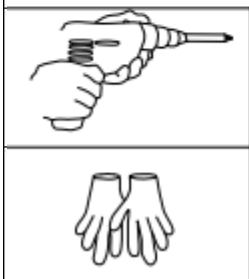
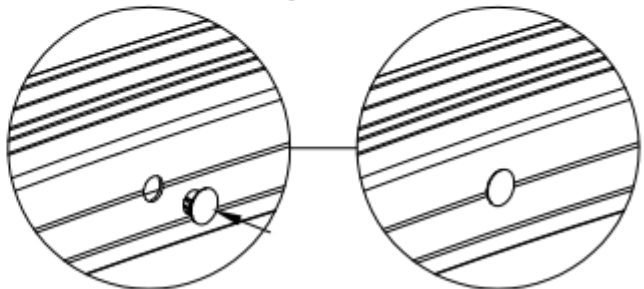
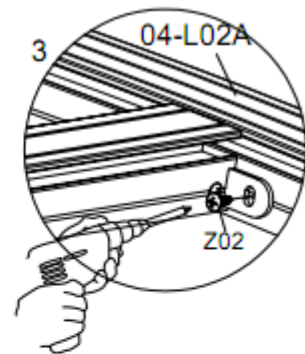
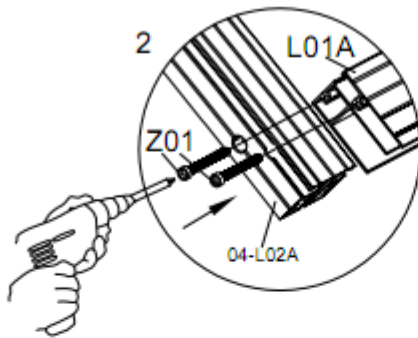
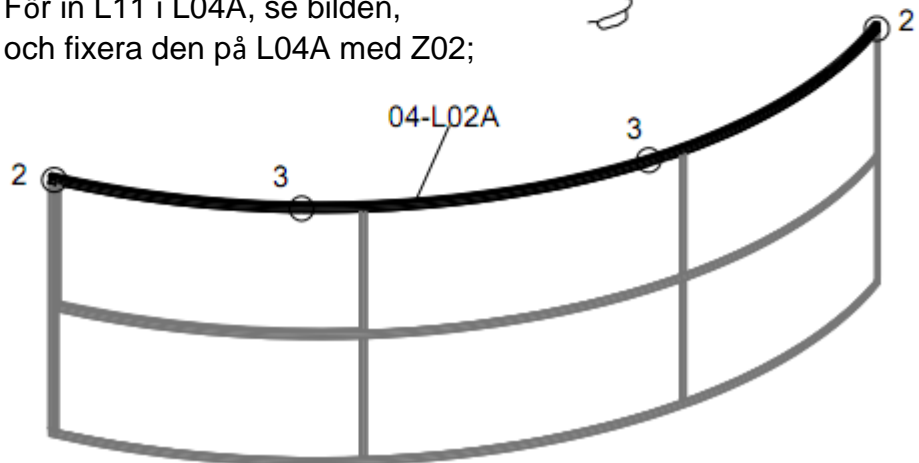

För in L11 i L04A, se bilden, och fixera den på L04A med Z02;

Montera ihop 04-L02A med L01A och L04A, använd Z01 & Z02.



Dölj alla hål med J01

PART	NO	QTY
	CX	1
	J01	12
	Z03 M4.2X25	2

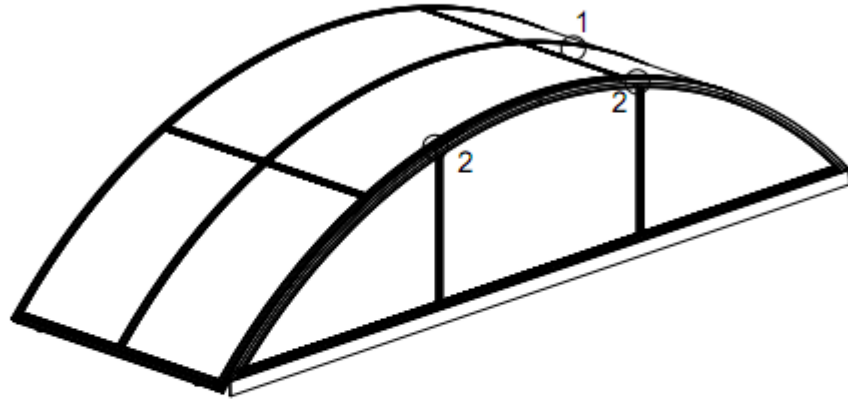

Montera CX på 04-L02A, 10 mm från nederkanten, med Z03.

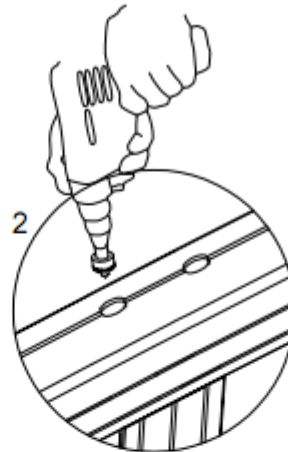
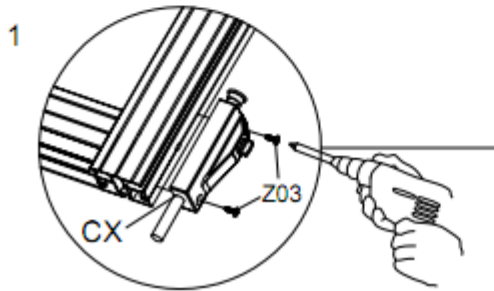



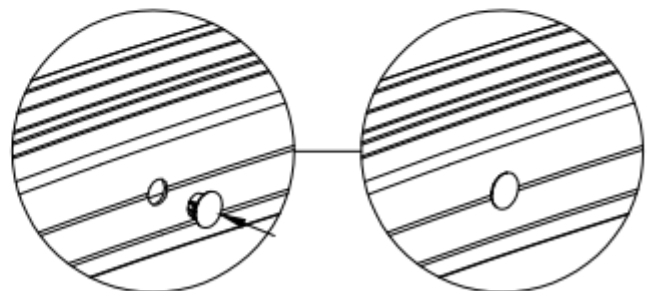



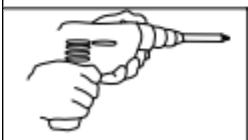

Hålen måste utvidgas till diameter 14 mm, använd en brotsch och en elskruvdragare.



Dölj alla hål med J01



PART	NO	QTY
	L06A	16
	L06B	8
	L12	16
	L13	4
	J01	104
	J02	104
	Z01 M6X60	104
	Z02 M4.2X16	48

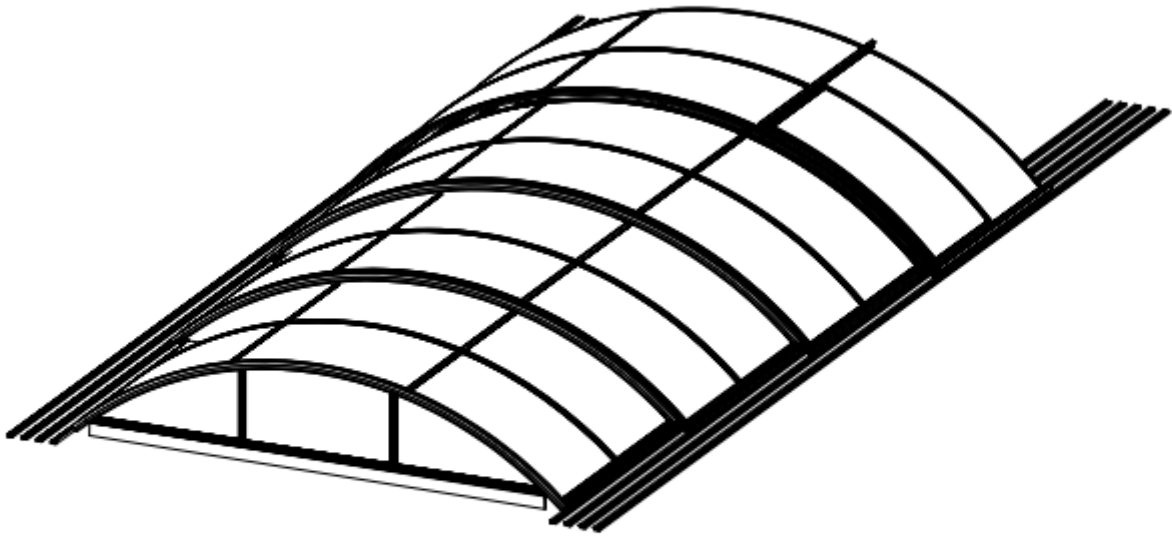

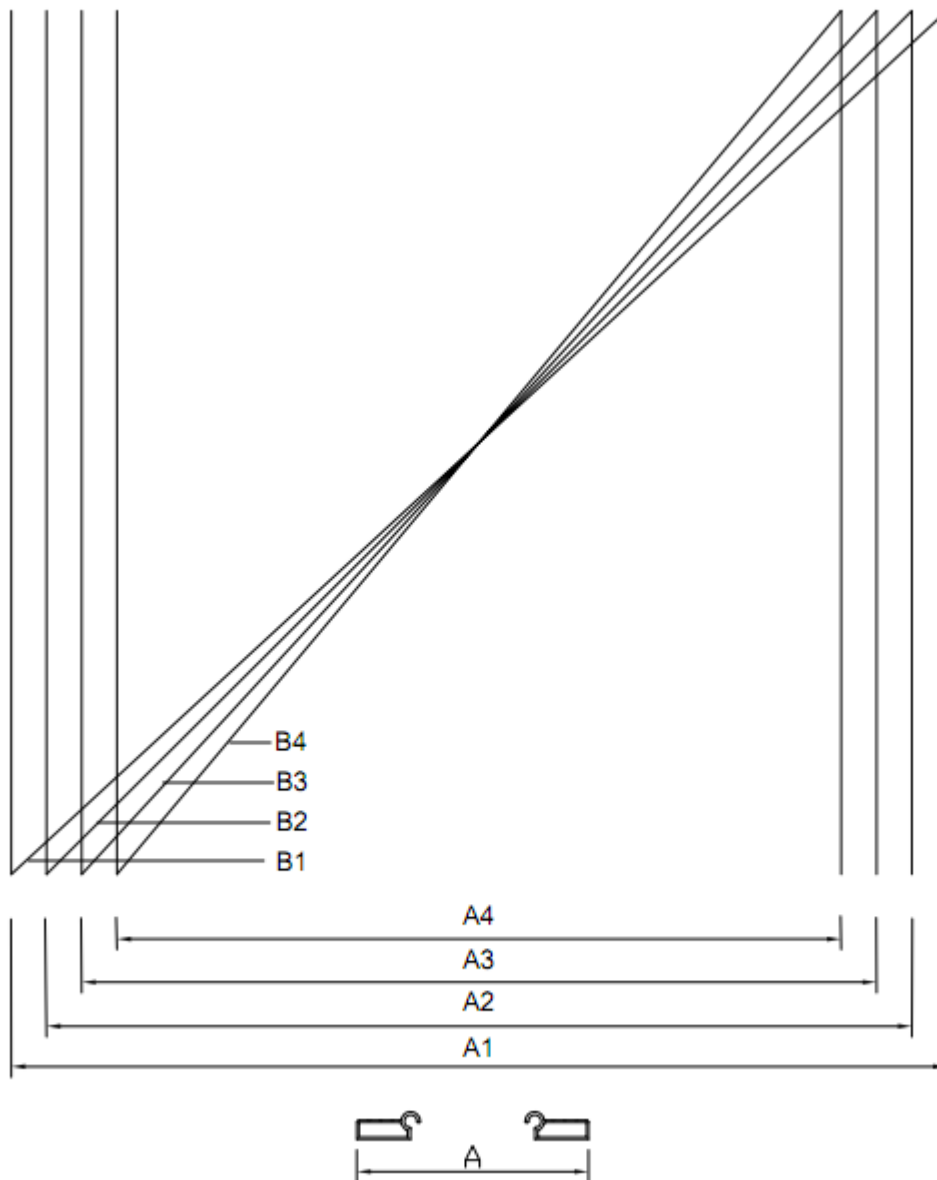

NR. mm	1	2	3	4
A (mm)	5 158	4 906	4 654	4 402
B (mm)	11 811	11 703	11 600	11 501

Mindre avvikelser mellan måtten här och i verkligheten är tillåtna.

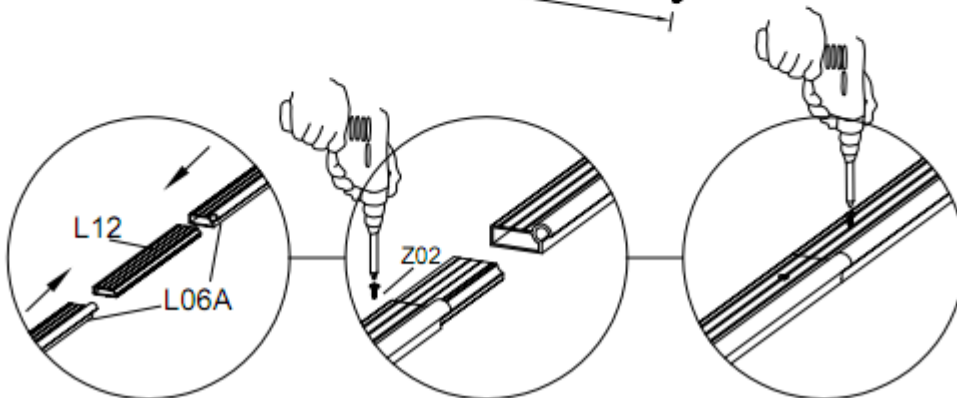
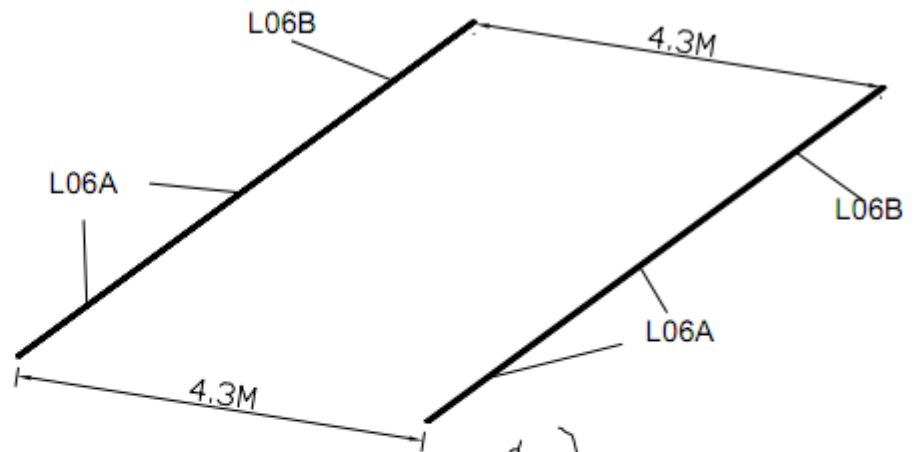

Sätt samman 2 st. L06A-delar och 1 st. L06B-del till en gemensam förlängd del genom att föra in L12 i båda ändarna och fixera dem med Z02.

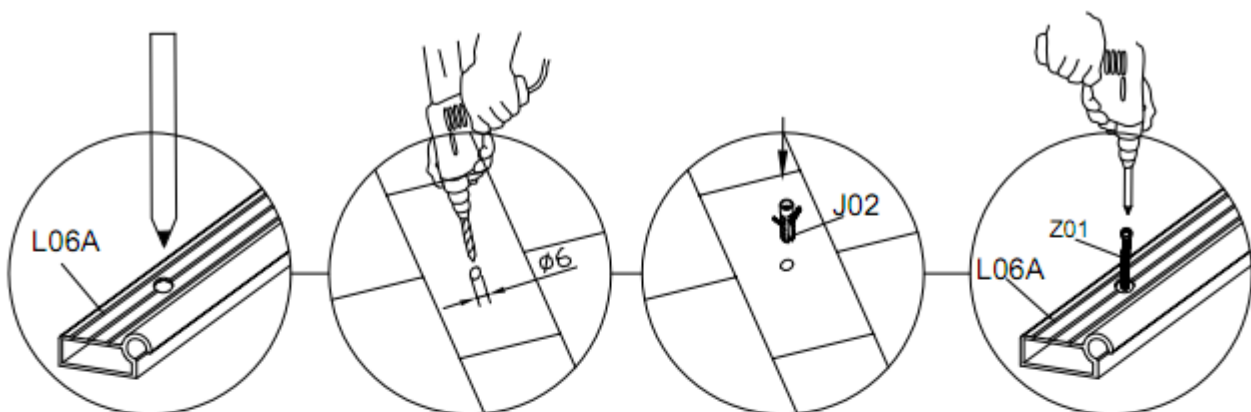

1. Lägg ut 2 st. spår på underlaget med rätt avstånd, se ovan.
2. Markera med en penna genom hålen i det ena spåret och borra sen hål med diameter 6 mm i underlaget.
3. Slå i J02 i hålen och fixera spår nr. 1 på underlaget genom hålen med Z01.
4. Kontrollera att det inre avståndet mellan spår nr. 2 och spår nr. 1 är 4 300 mm och att det yttre avståndet mellan dem är 4 402 mm.
5. Fäst inte spår nr. 2 i underlaget förrän K4 går att flytta smidigt i de två spåren.

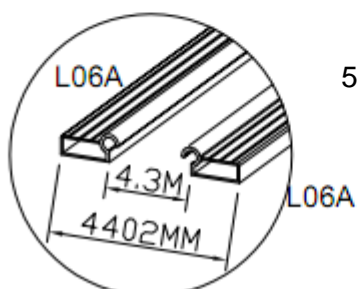
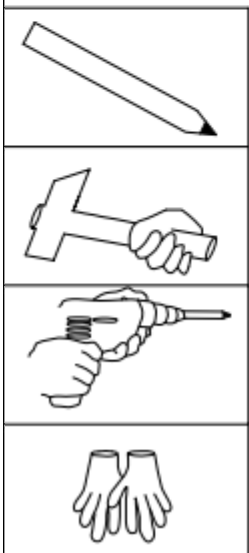

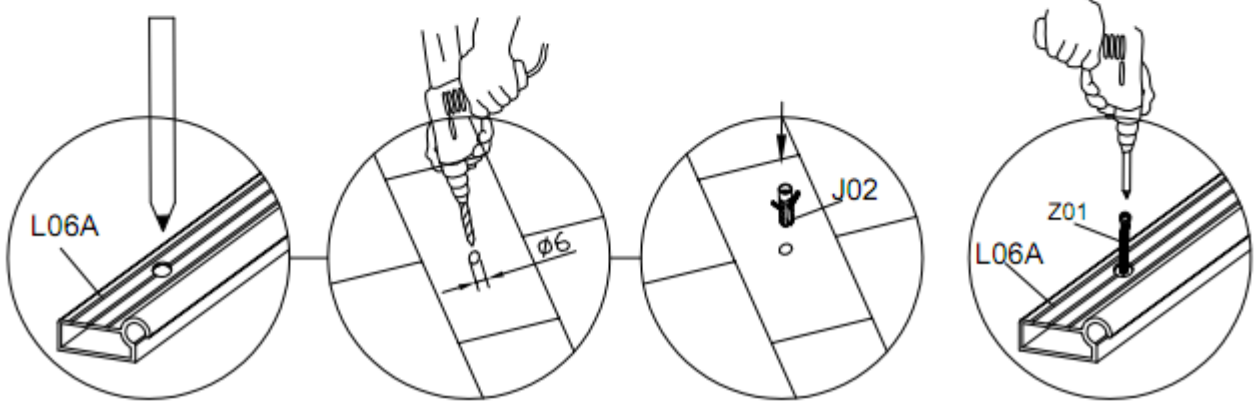
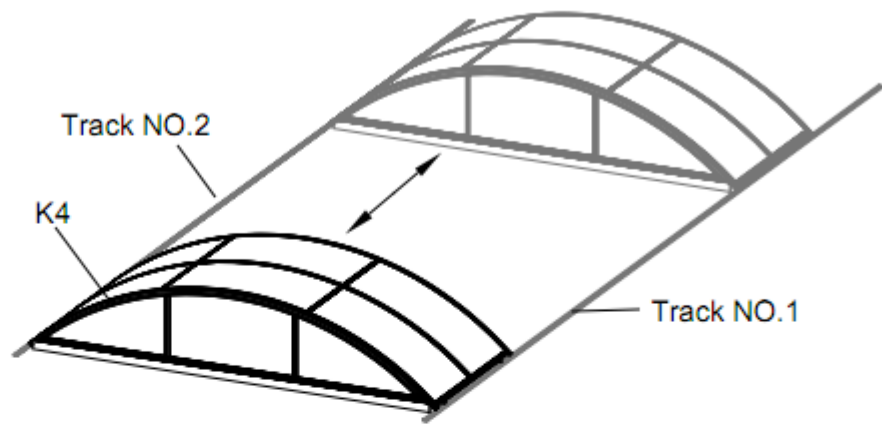

1. Placera K4 i de två spåren och justera spår nr. 2 tills K4 går att flytta smidigt.
2. Markera med en penna på underlaget genom hålen i spåret. Borra sen hål med 6 mm diameter i underlaget.
3. Slå i J02 i hålen och fixera spår nr. 2 i underlaget genom hålen med Z01.

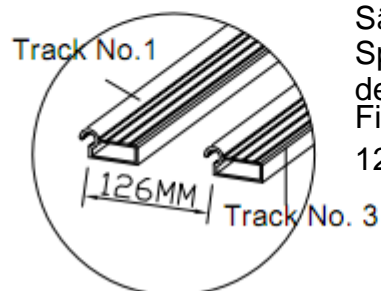
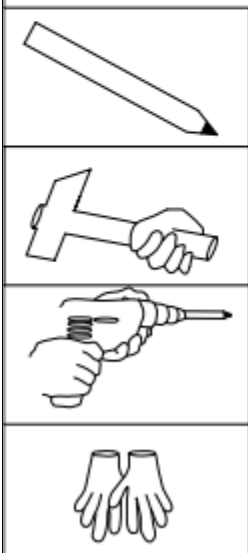
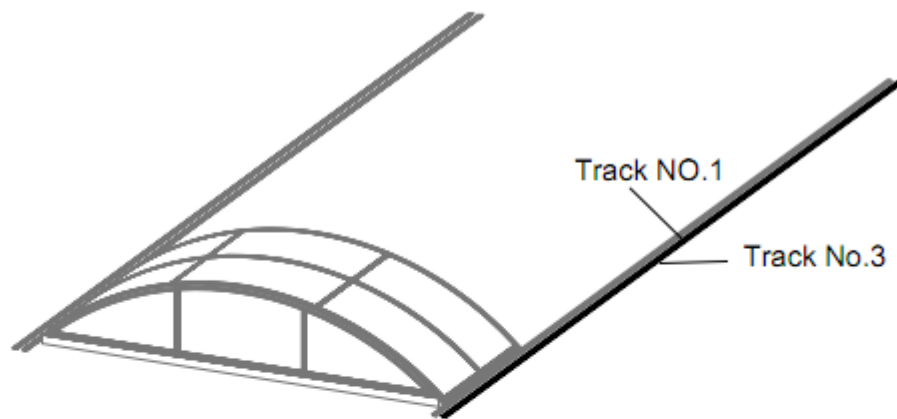

Sätt ihop 2 st. L06A med 1 st. L06B till ett enda förlängt Spår genom att föra in L12 i de båda ändarna och fixera dem med Z02.
 Fixera spår nr. 3 i underlaget, se ovan, 126 mm från spår nr. 1, se nedan.

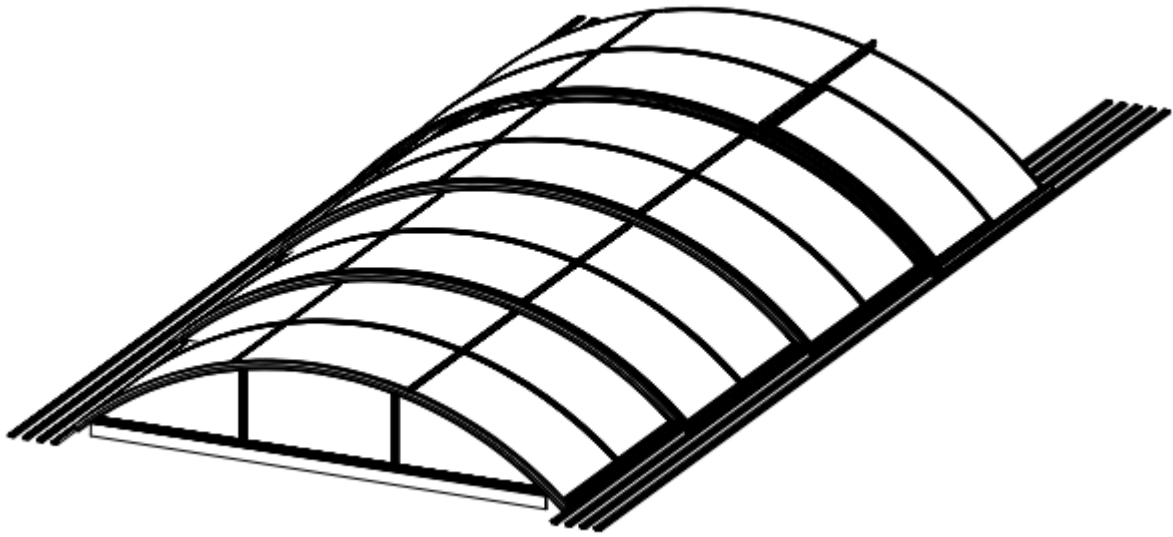

Fixera resterande spår på samma sätt som ovan.
Se till att alla delar av pooltaket går att flytta smidigt
innan du drar åt skruvorna ordentligt.

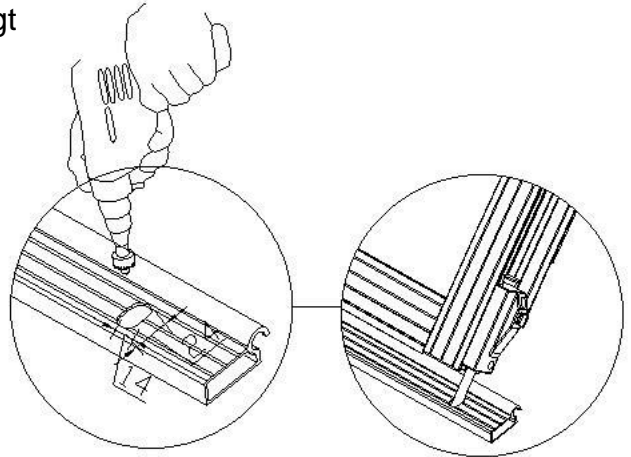
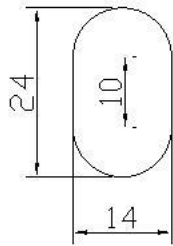

Borra 6 ovala hål (14 x 24 mm) i spåren, motsvarande de 6 låsen (CX).
På så sätt kan du låsa pooltaket när du stänger det.

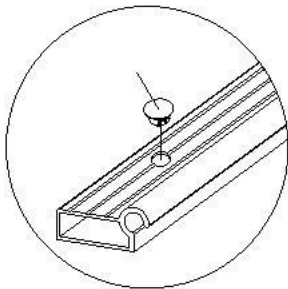

Dölj alla hålen i spåren med J01

Konsumentkontakt
Arc E-commerce AB
Box 3124
13603 Haninge
Sverige

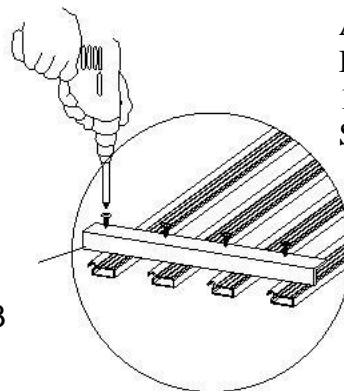

Sist av allt fäster du L13
(4 st.) i spårens ändar
med Z02.

