

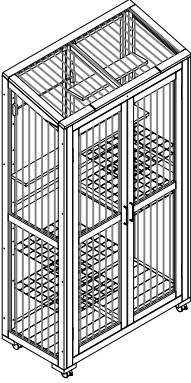

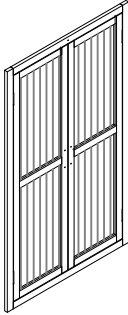







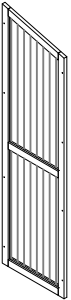
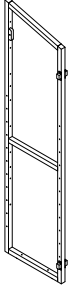
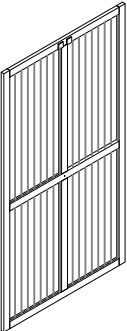
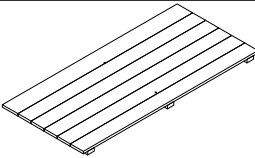
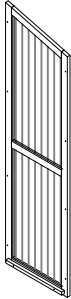
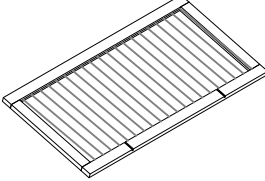

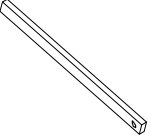

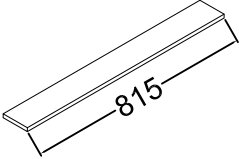
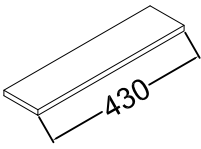
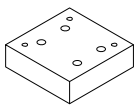
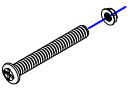

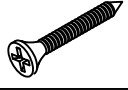
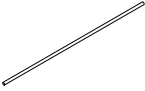
ASSEMBLY INSTRUCTIONS

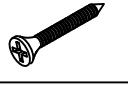
			6		1PC
			7		2PCS
1		1PC	8		1PC
2		1PC	9		1PC
3		1PC	10		1PC
4		1PC	11		1PC
5		1PC	12		1PC
			13		1PC
			14		4PCS

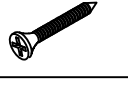
A		Ø6*25	16PCS	H		16PCS
B		3.5*40	12PCS	I		1PC
C		3.5*35	37PCS	J		5PCS
D		3.5*25	1PC	K		2PCS
E		3*16	4PCS	L		2PCS
F			4PCS	M		2PCS
G			3PCS			

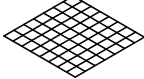
1

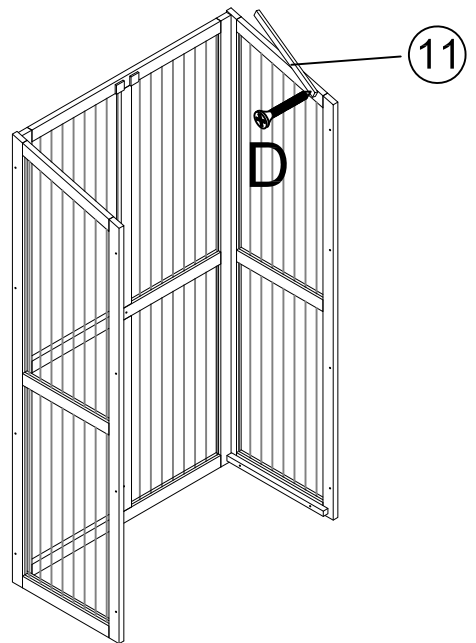
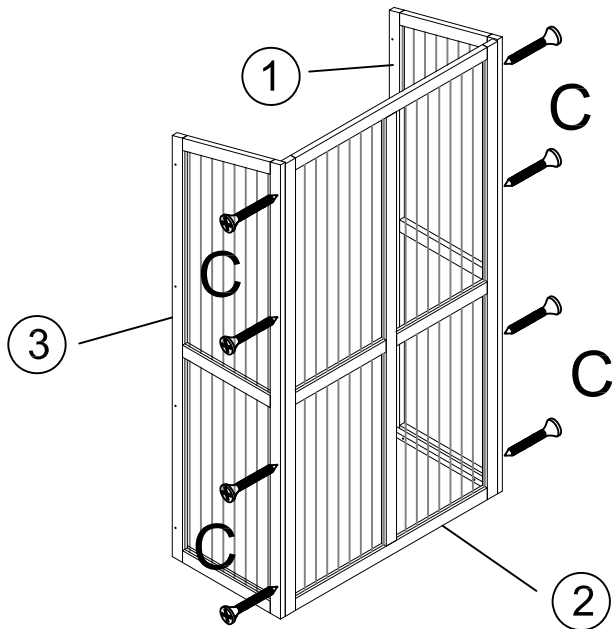

2

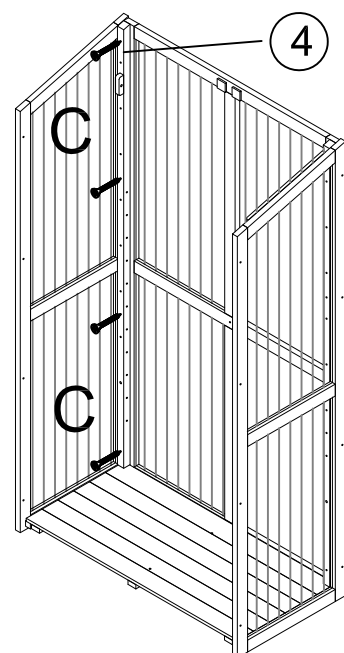
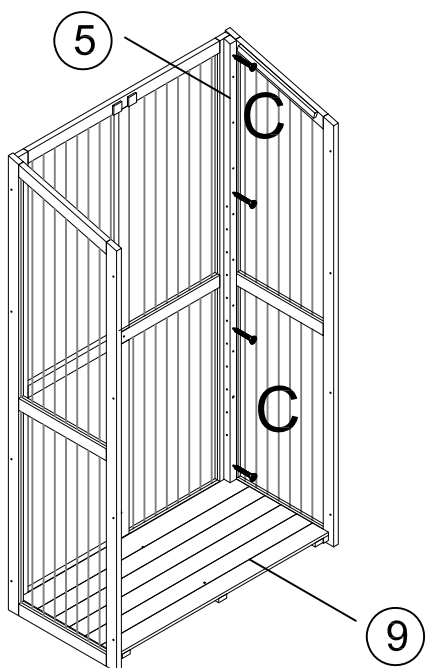

3

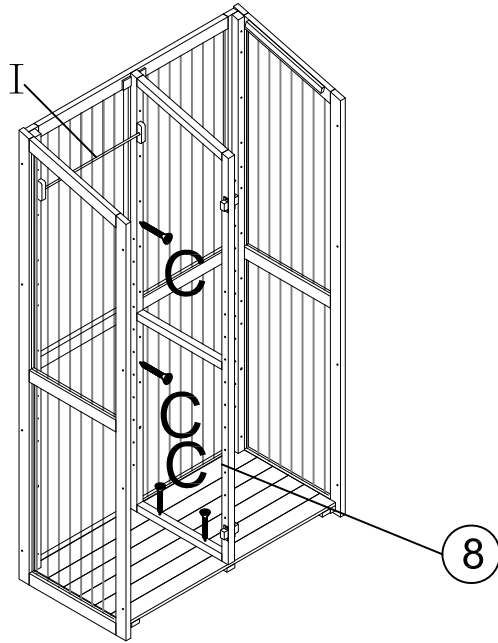

4

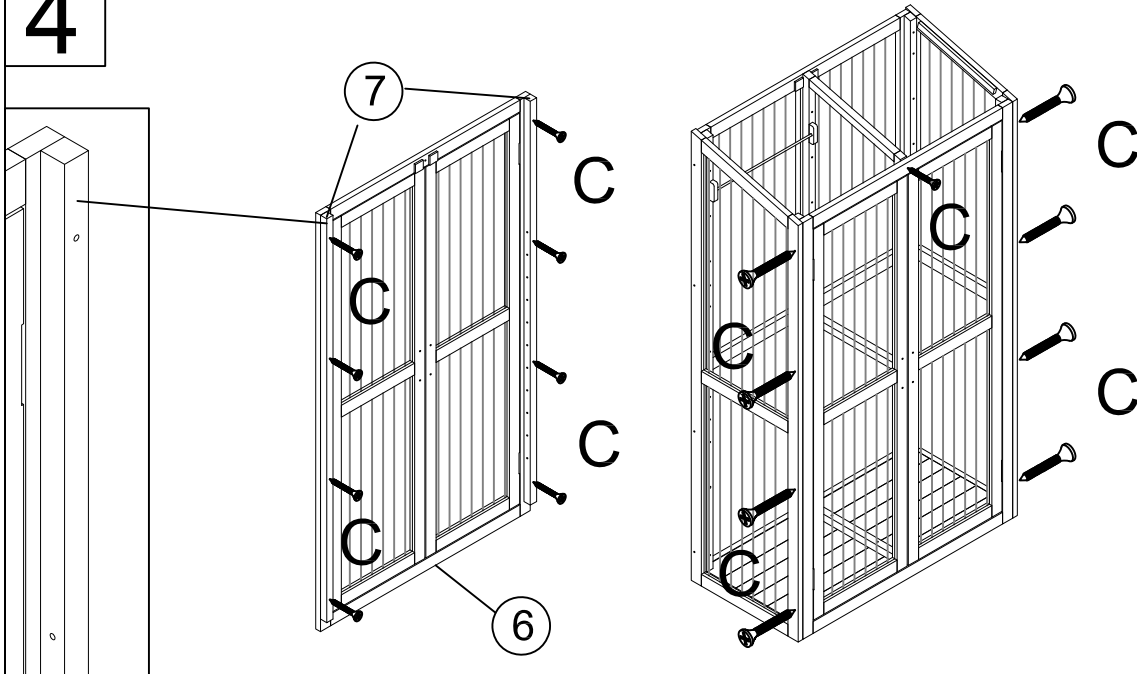

5

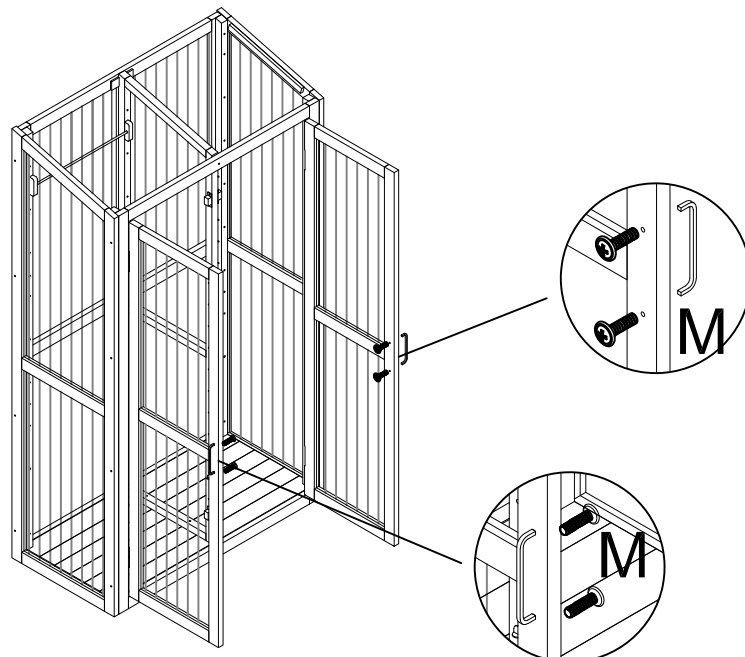

6

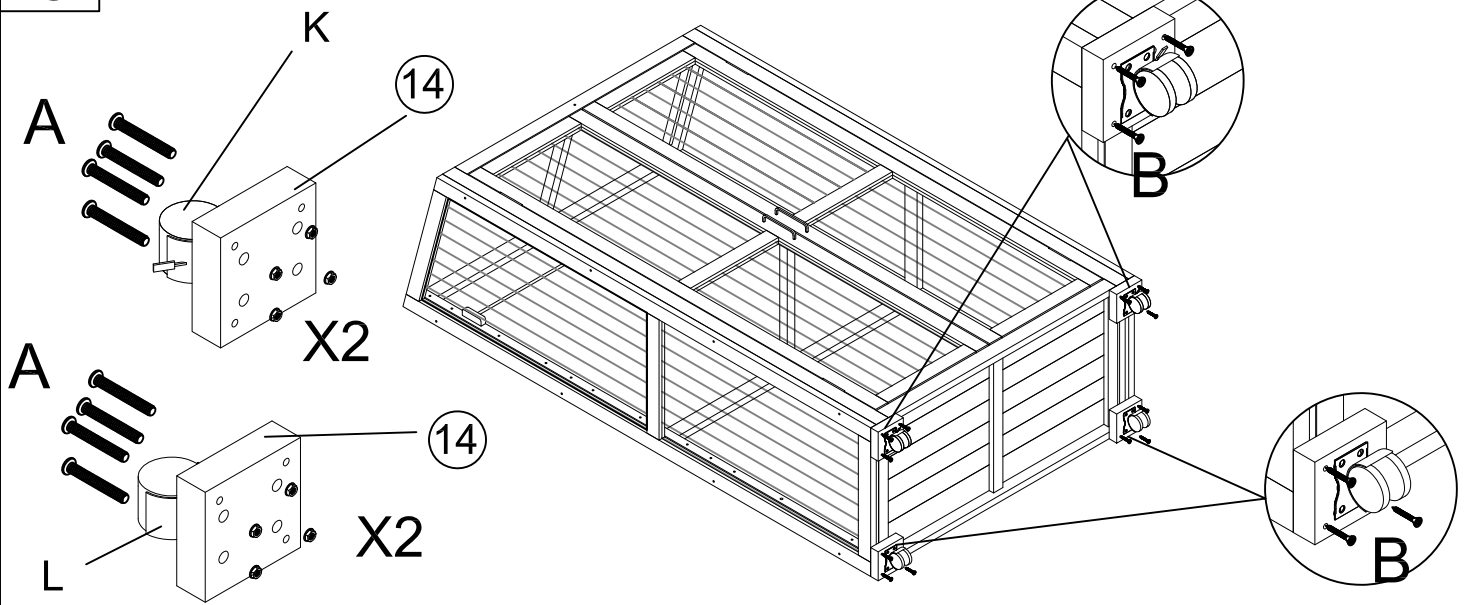

7

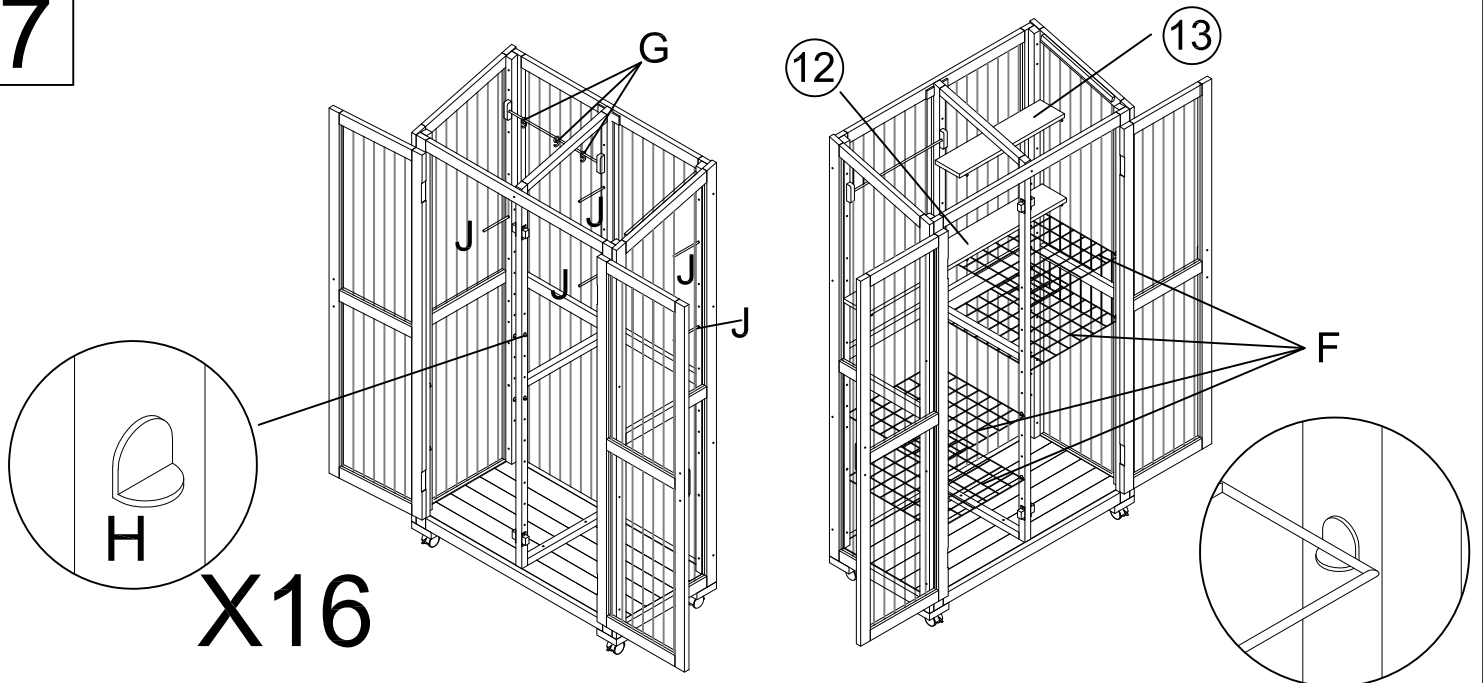

8

