

# HÖRNSOFFA

## VÄNDBAR

506247

506248

506249

506250

514153



12 cm

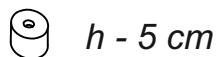



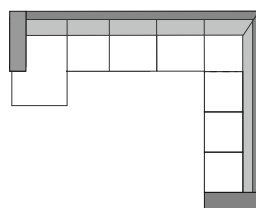



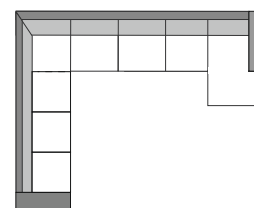





$h - 5 \text{ cm}$



D4C3



3C4D

A		16
B		16
C		16
D		1
E	 120cm	6
F	 5 cm	8
G	 För benen For legs	20
H		1
I		1
J		12
K		24
L		1

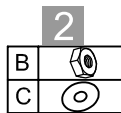
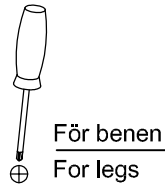

Ställ sitsen ovanpå ryggen på bultarna, trä på brickor och skruva dit muttrar, **men spänn inte åt.**

Place the seat in top of the back above the bolts, add washers and assemble nuts on each bolt, **but keep it loose.**

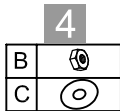
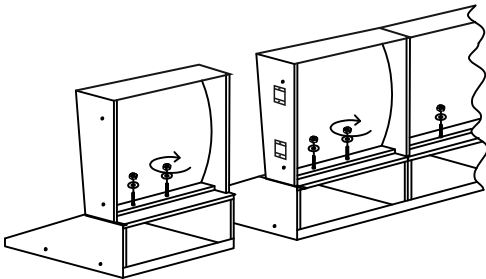

För in armstödet med rygg och sits. Montera brickor och muttrar men **spänn inte åt muttrarna.**

Put the armrest together with the backrest and the seat. Assemble washers and nuts, **but keep it loose.**

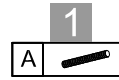
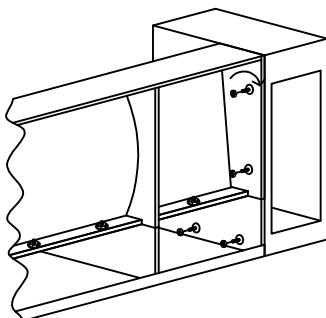

Lägg ryggen på ett mjukt underlag och skruva i en pinnbult i varje hål.

Place the back on a smooth surface and assemble a bolt in each hole.

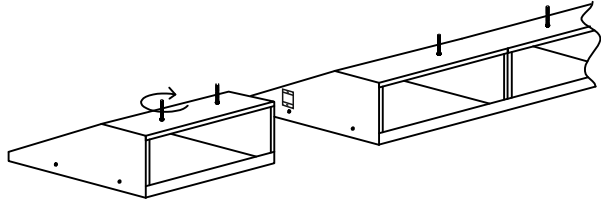

Skruva i en pinnbult i varje hål på armstöden.

Assemble one bolt in each hole in the armrest.

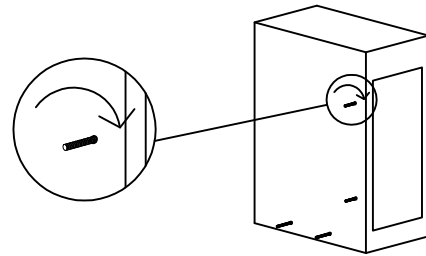

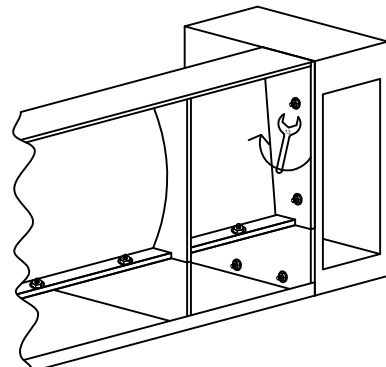

Kontrollera att samtliga skarvar är jämna, spänn därefter åt alla muttrar ordentligt.

Check that all joints are smooth. Then screw all nuts tightly.



6

E		120cm	6
F			8
G		For benen For legs	20

Montera benen.  
Assemble the legs.

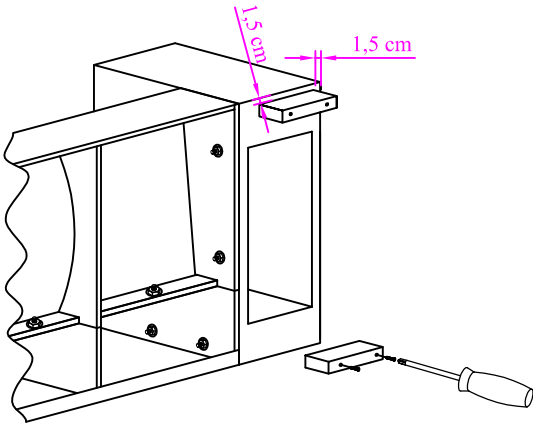

Notera benens placering.



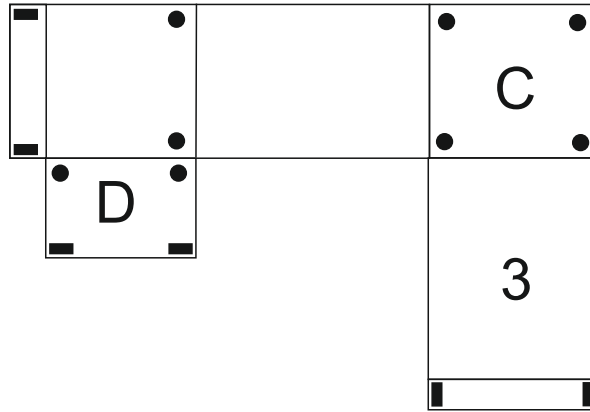

Note where the legs shall be placed.

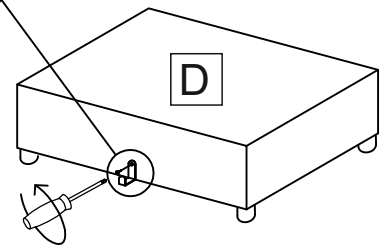
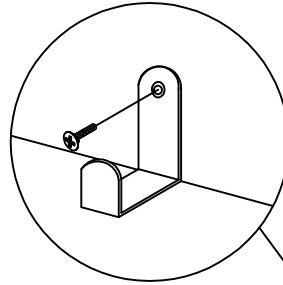

D1



7

H			1
I			1
J			12
K			24
L			1

Montera divanpallens krok enligt bilden  
Assemble the hook on the divan foot-stool.

Montera hakbeslagen enligt bild med hjälp av insexnyckeln.  
Montera nu ihop soffan med kroken.

Mount metal hook plates as shown using the Allen key.  
Now assemble all sections together with the hook.

D1

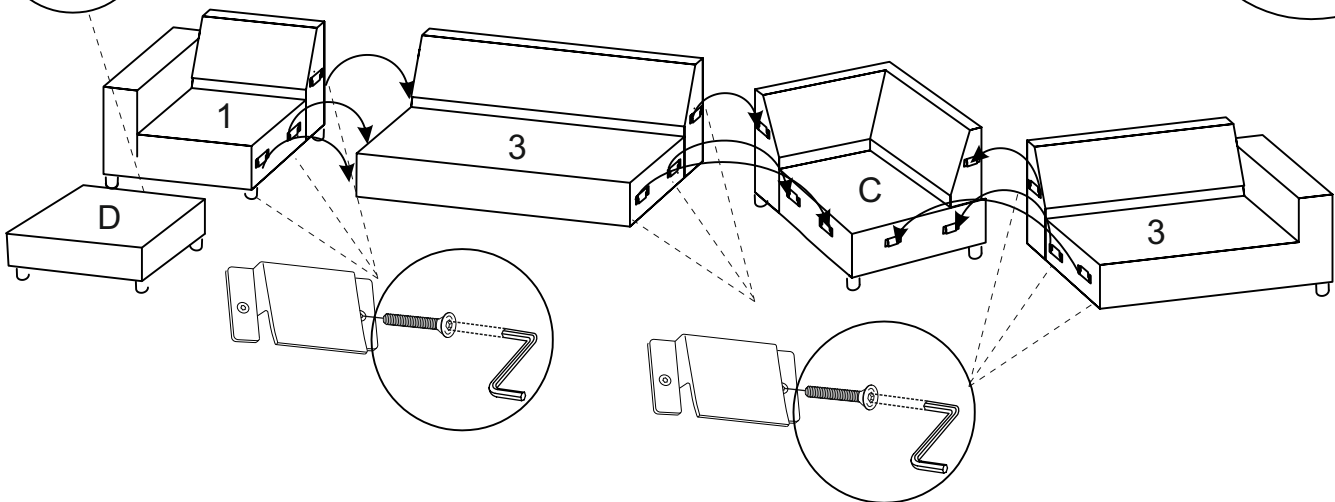
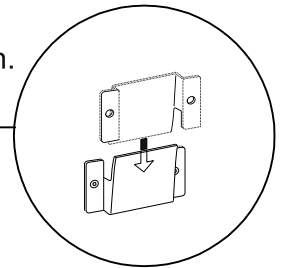
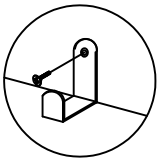

## SV

- Släng inget emballage innan ni har monterat möbelen, titta igenom noga så alla delar finns med.
- För att undvika skador, montera möbel på mjukt underlag.
- Bult o skruv kan lossa över tid, kontrollera och efterdra.
- Undvik att ställa möbelen i direkt solljus eller för nära element.
- Får inte användas utomhus!



- Tvätta som PU, med våt trasa, lätt jlummen tvål-lösning  
Tvätta ej med läder - rengöring.  
Särskild rengöring för PU kan också användas.



- Varsam kemtvätt  
Ej vattentvätt  
Ej strykning

## EN

- Do not throw away the packing materials until assembly is complete;
- To avoid scratch or other damages: assemble this item on a soft surface, such as cardboard or carpet, to protect finish;
- Hardware may loosen overtime. Periodically check that all connections are tight ;
- Protect sofa from an environmental factors such as : heat, direct sunlight (especially leather surface) and humidity;
- Do not use sofa outdoors.

### PU Leather cleaning:



- Cleaning like PU, with wet cloth, soupy warm water.  
No way with leather cleansers.  
Also, there are special cleansers for PU that can be used.

### Fabric cleaning:



- Very gentle cleaning with PCE  
Do not wash  
Do not iron