

Växthus Monteringsanvisning

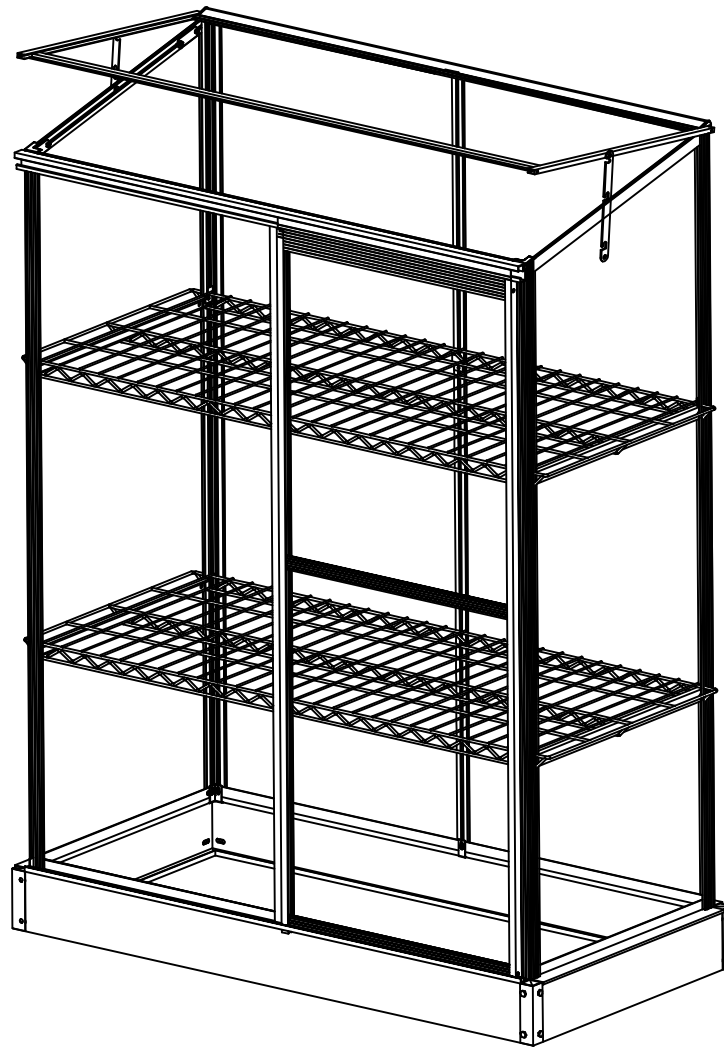

METALCRAFT



M-K

VIKTIGT

Du måste läsa anvisningen noggrant innan du börjar montera växthuset. Se till att alla delar finns med i kartongen, och att typ och antal stämmer enligt den lista som finns på respektive sida. Utför monteringen i den ordning som anges i anvisningen. Spänn inte skruvarna förrän monteringen av polykarbonatskivorna är färdig. Förvara anvisningen på ett tryggt ställe för ev. framtida bruk.

SÄKERHETSANVISNINGAR

Vi rekommenderar starkt att du använder arbetshandskar under monteringen. Montera inte ditt växthus när det blåser eller regnar.

Växthusets aluminiumprofiler får inte komma i kontakt med några nedhängande elkablar. Använd alltid skor och skyddsglasögon när du arbetar med strängsprutad aluminium.

Kasta bort alla plastpåsar direkt och se till att de är utom räckhåll för små barn p.g.a. kvävningsrisken.

Växthuset måste placeras och sättas fast på en jämn yta.

Luta dig inte mot växthuset och tryck inte på det under själva arbetet med uppbyggnaden av det.

Håll barn borta från området under monteringen.

Placera inte ditt växthus på något område som utsätts för hård vind.

Utför inte monteringen av växthuset om du är trött, under påverkan av alkohol eller droger eller om du lätt drabbas av yrsel.

Om du använder stege eller elverktyg under monteringen, se till att du följer tillverkarens anvisningar. Varma föremål, som t.ex. en nyligen använd grill, en blåslampa etc. får inte förvaras inne i växthuset. Säkerställ att det inte finns några dolda rör eller kablar i marken, innan du slår i pinnarna i marken.

ALLMÄNNA RÅD

Växthuset har många delar att montera, så räkna med minst 5 timmars monterings tid totalt.

Vid val av växthusets placering, välj en solig och jämn plats utan några överhängande trädgrenar.

Om du sätter fast ditt växthus direkt på en betonggrund, använd de förborrade hålen som finns i metallramen. Alla komponenter bör kontrolleras och läggas fram så att du enkelt når dem under monteringsarbetet.

Lägg alla smådelar (skruvar etc.) i en skål så de inte kommer bort.

Observera att dörren har gångjärn på höger sida, och öppnas därför åt höger.

Håll taket rent från snö och löv.

SKÖTSEL & UNDERHÅLL

När du behöver rengöra ditt växthus, använd en mild blandning av vatten och diskmedel och skölj med kallt, rent vatten.

Använd INTE aceton, rengöringsmedel med slipmedel eller andra specialrengöringsmedel vid rengöring av de genomskinliga skivorna.

VERKTYG & UTRUSTNING SOM KRÄVS



Silikonfogmassa, silikonpistol, handskruvmejsel och trappstege

Måttband, stor hammare, sax.



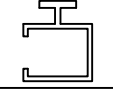
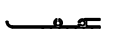
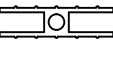

Arbetshandskar, borrar, borrardragare, smörjmedel, hammare i plast eller gummi, 2,0 mm metallborr.

Om du behöver, be om professionell hjälp i din butik.

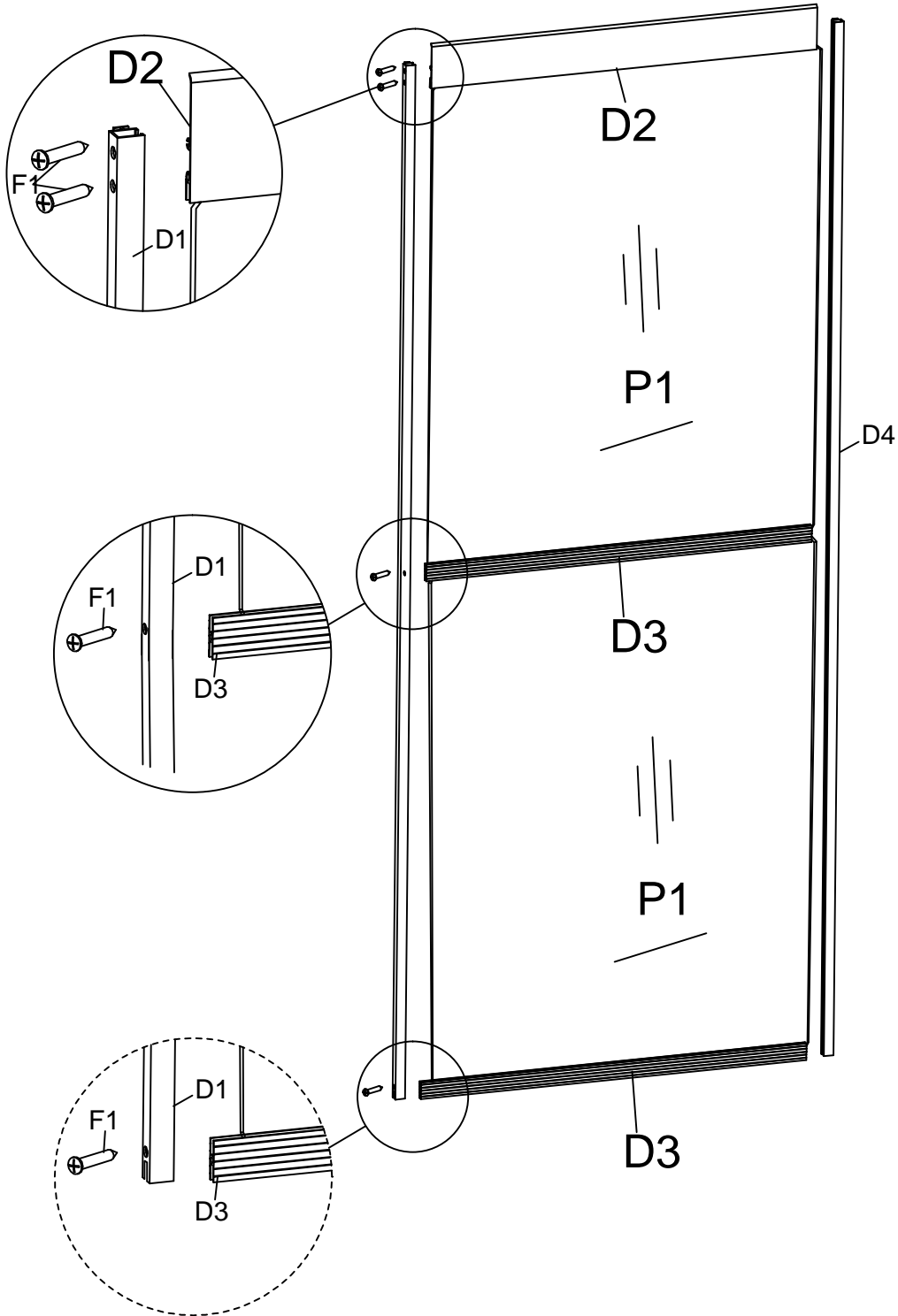
DÖRR

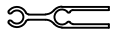
DEL	NR.	ANTAL
	D1	1
	D4	1
	D2	1
	D3	2
	F1	8

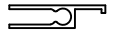

DEL	NR.	ANTAL
	W1	1
	W2	2
	W3	1
	P2	1
	F2	6

FÖNSTER

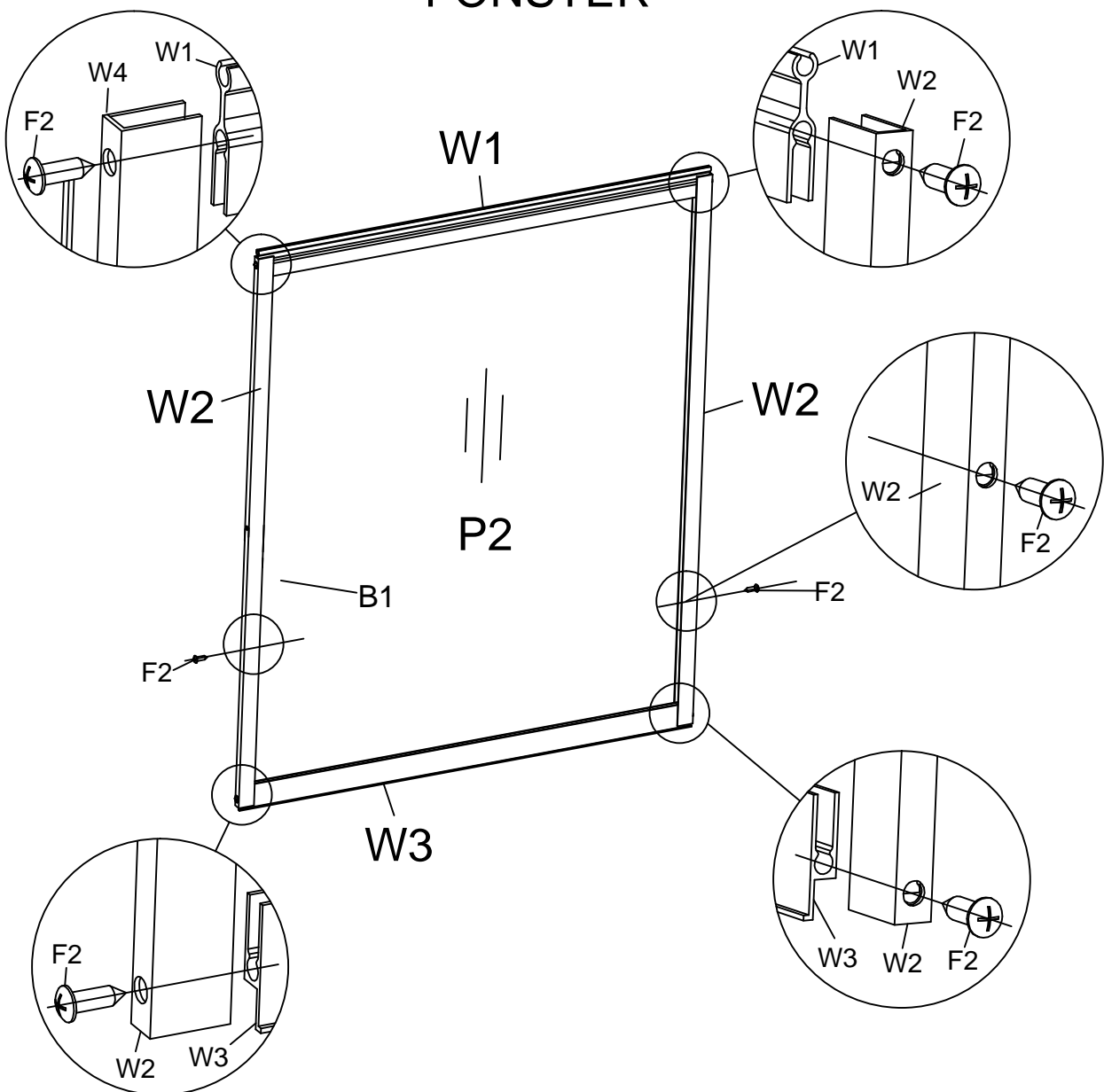

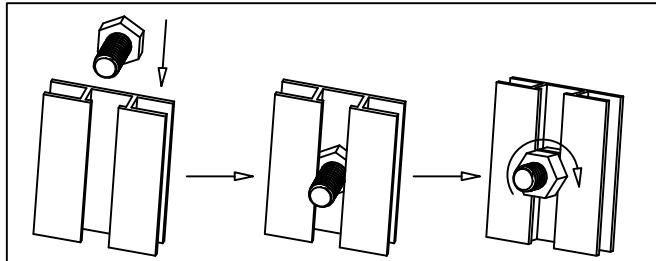
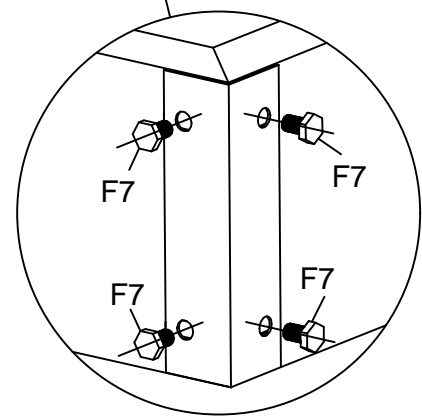
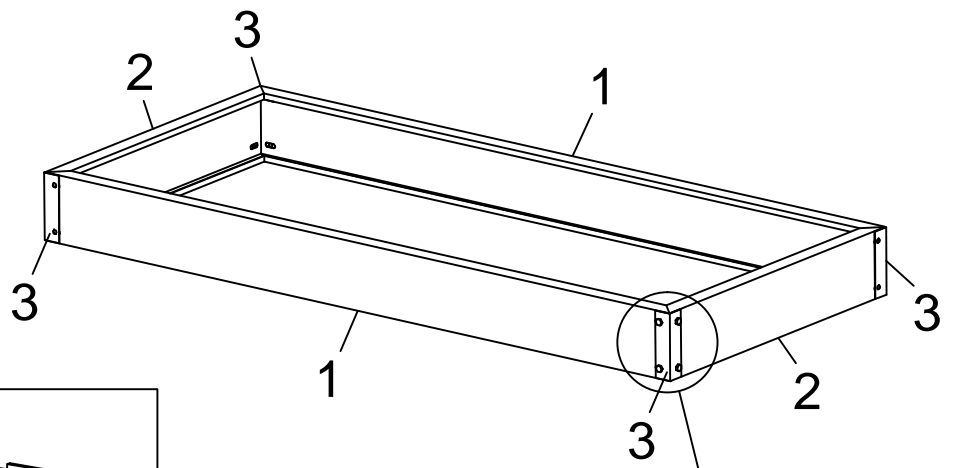





Montering av "sexkantsskruv"

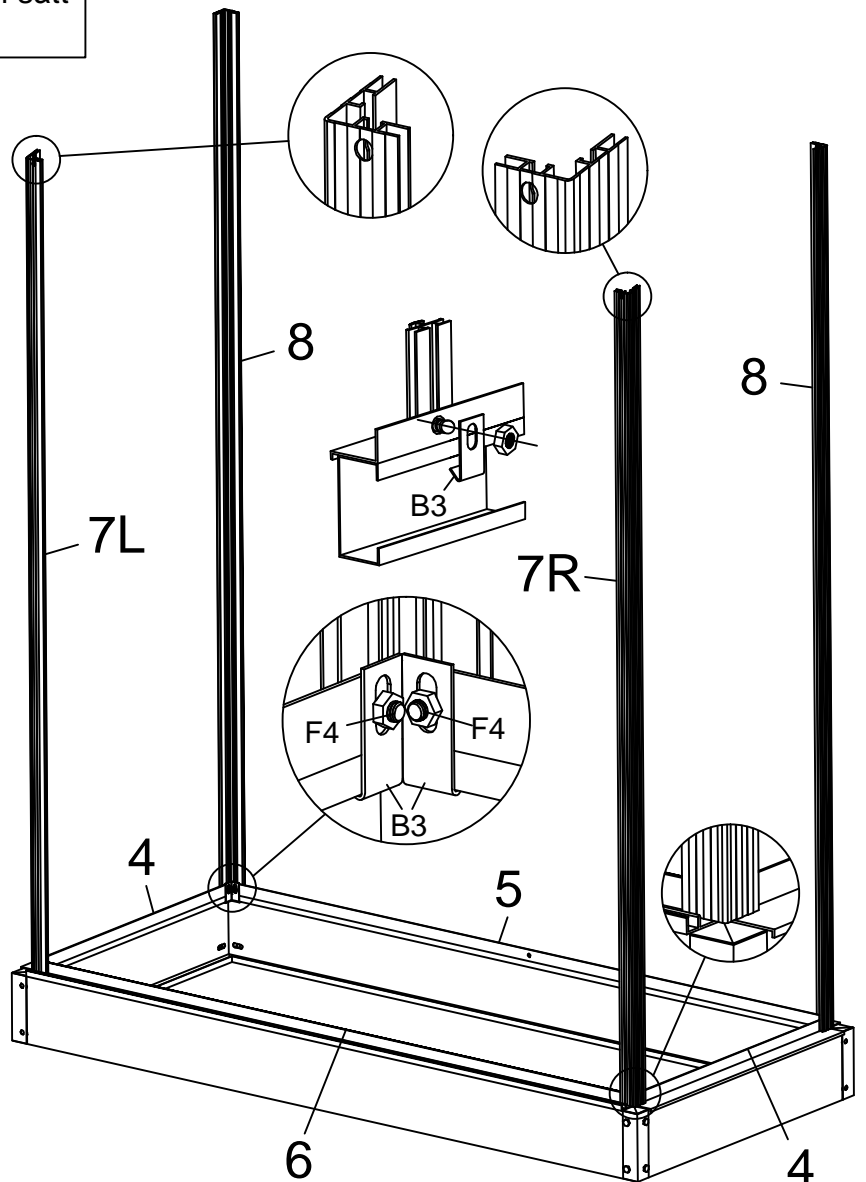

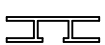

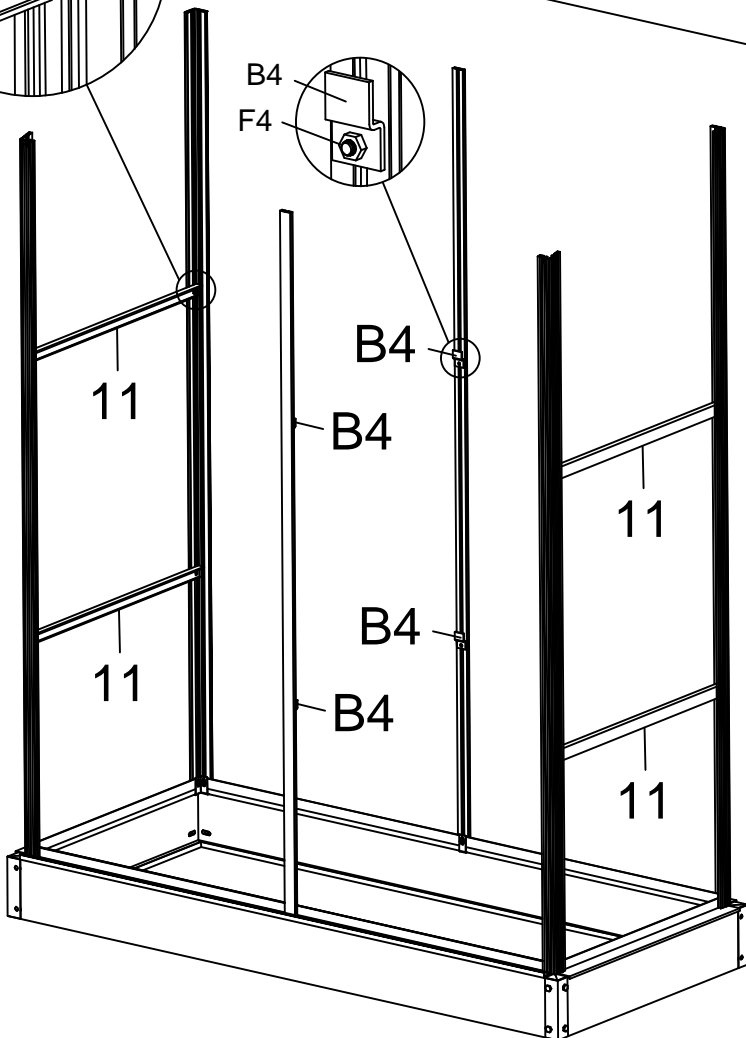
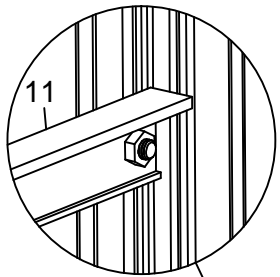
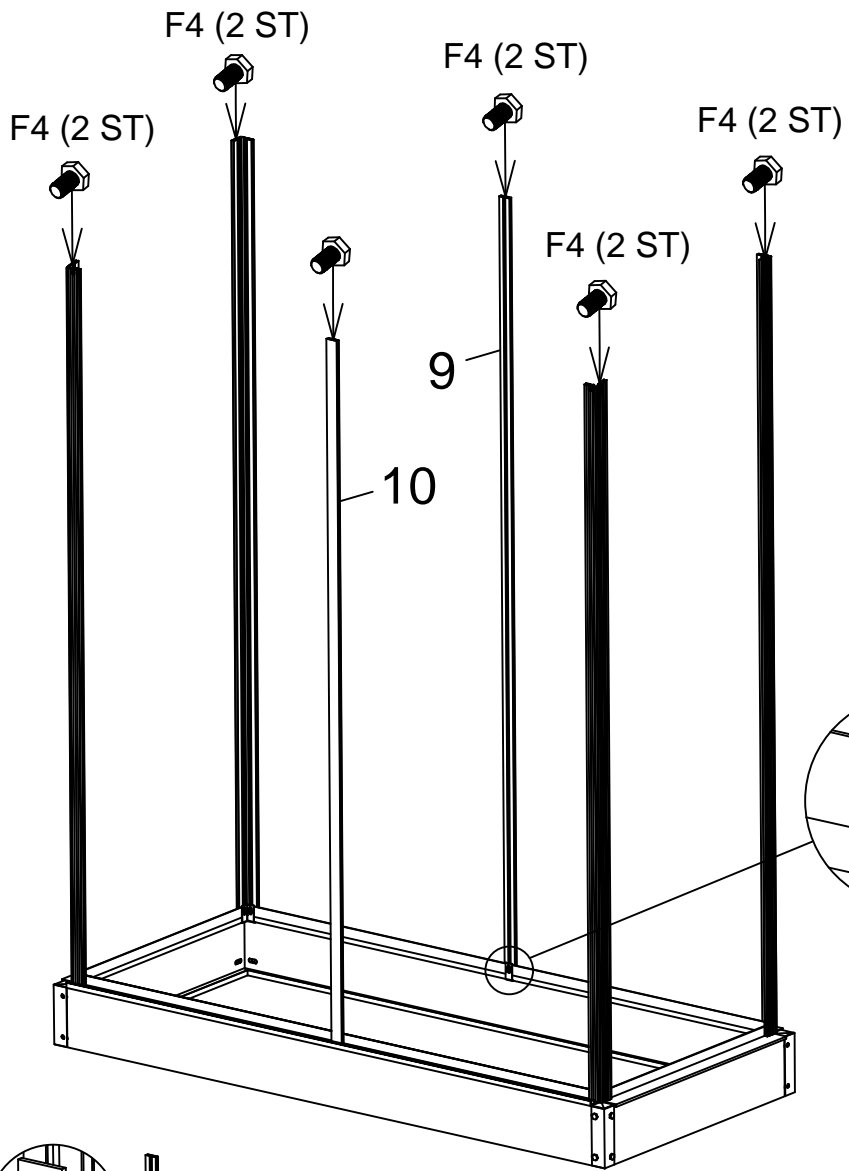

Sätt "sexkantsskraven" i spåret, vrid medsols tills den inte går att vrida längre. Justera "sexkantsskraven" för hand och vrid den så att gängorna håller den på plats. Sätt på de andra delarna på "sexkantsskraven" och sätt på muttern.

DEL	NR.	ANTAL
	1	2
	2	2
	3	4
	4	2
	5	1
	6	1
	7R	1
	7L	1
	8	2
	B3	8
	F7	16
	F4	8



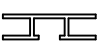

DEL	NR.	ANTAL
	9	1
	10	1
	11	4
	B3	2
	B4	4
	F4	14

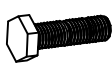

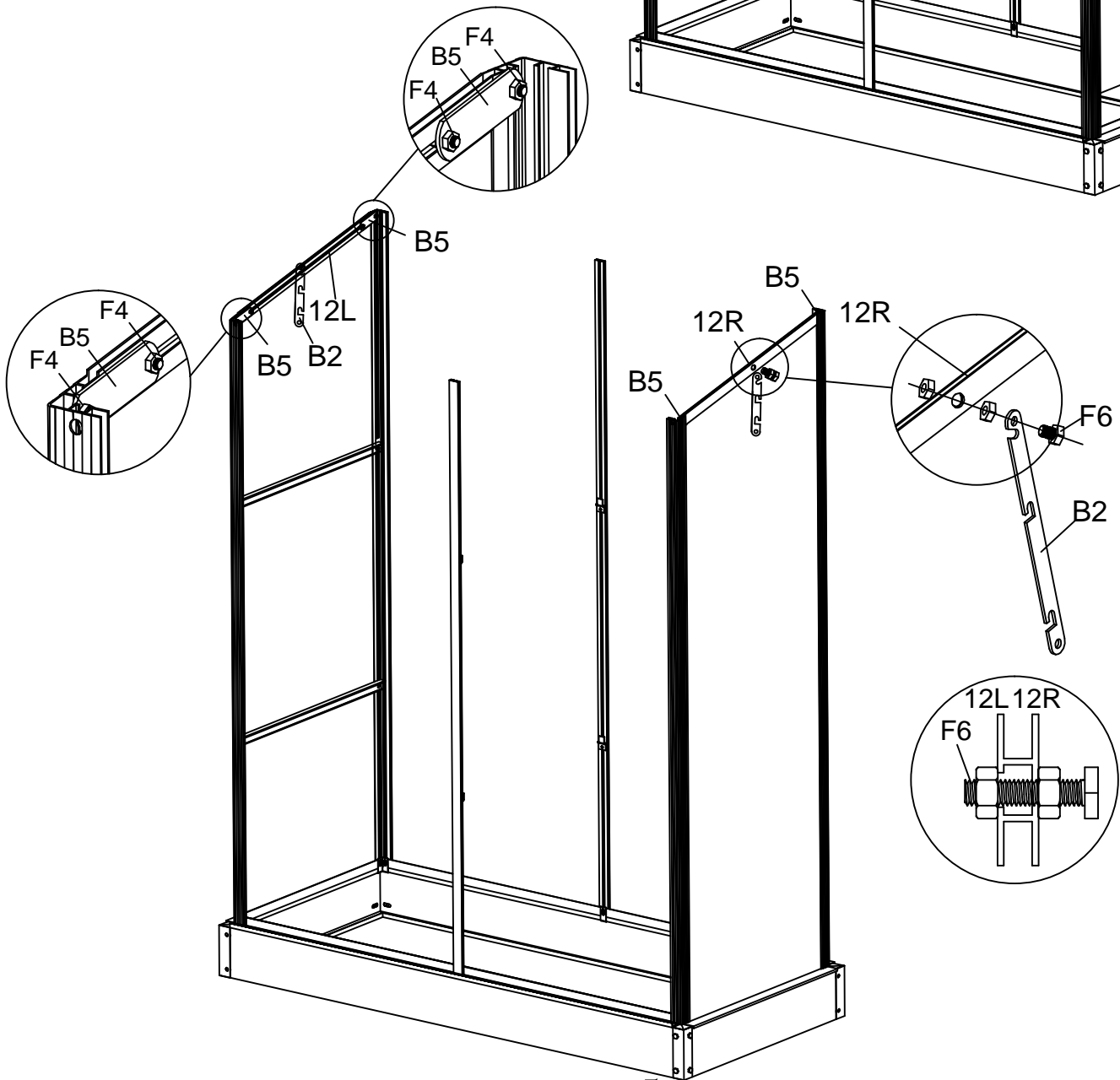
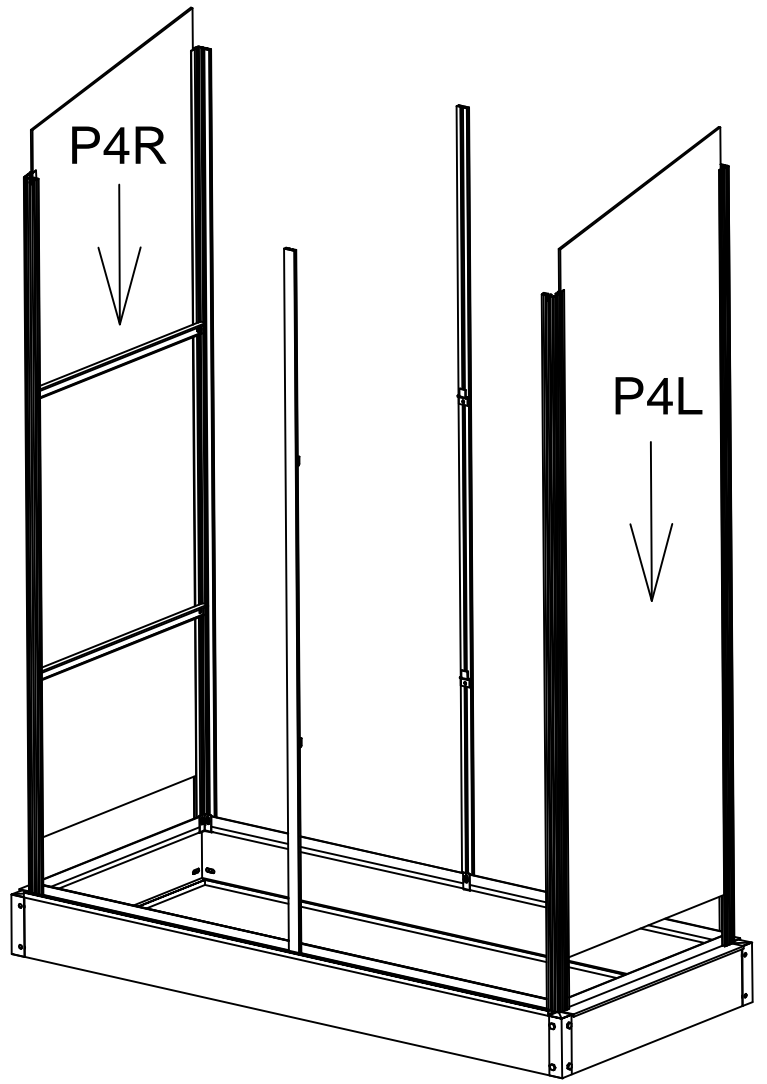

DEL	NR.	ANTAL
	P4R	1
	P4L	1
	12R	1
	12L	1
	B5	4
	B2	2
	F4	8
	F6	2

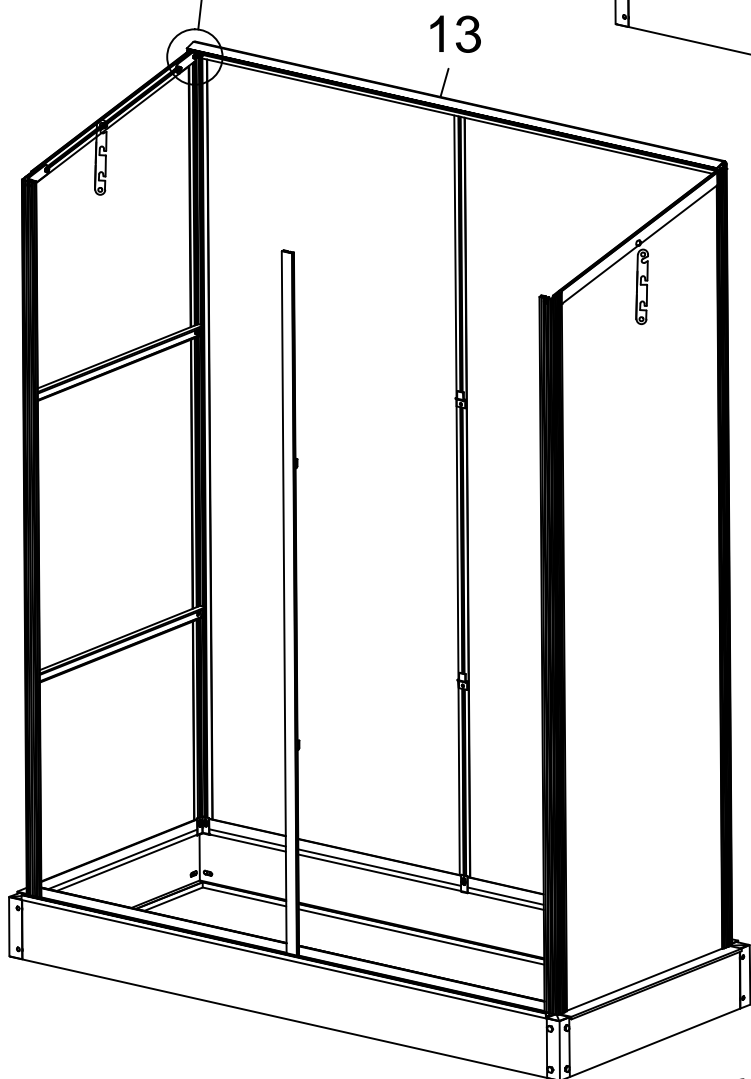
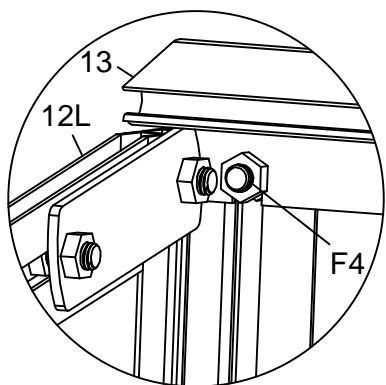
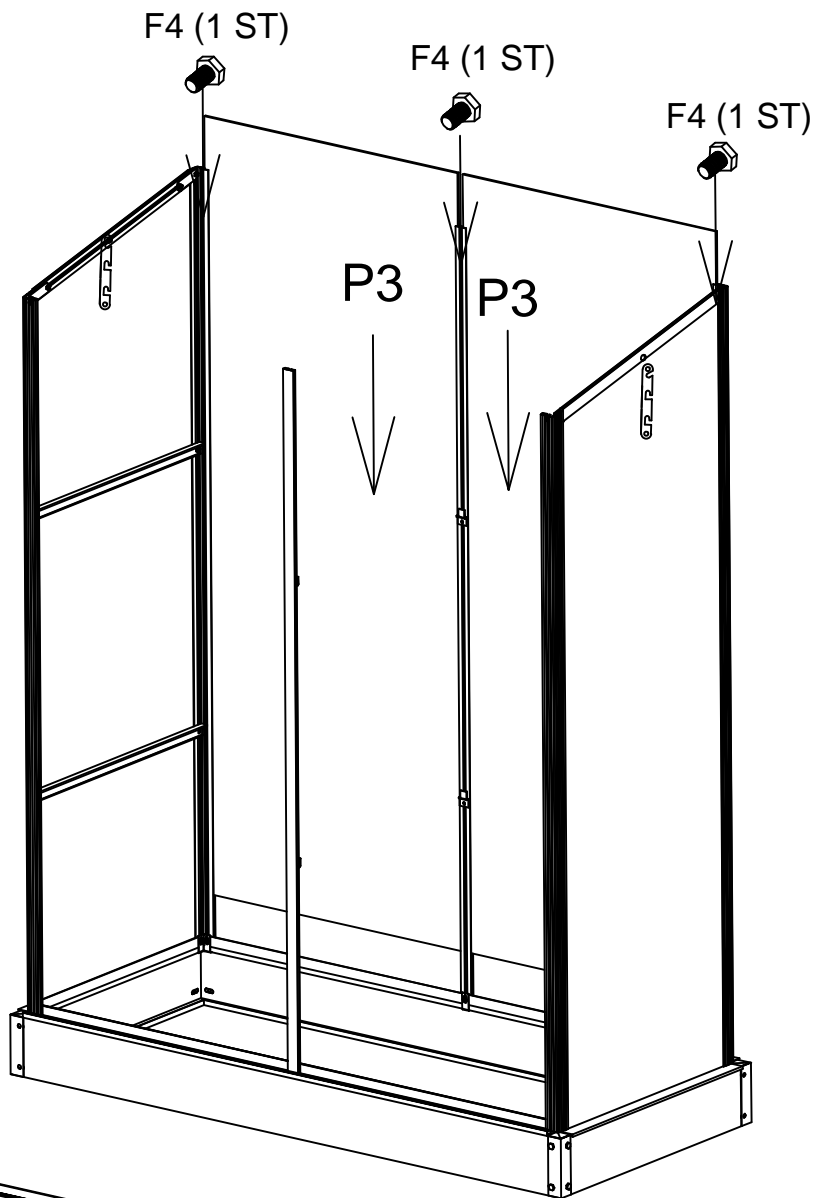

DEL	NR.	ANTAL
	P3	2
	13	1
	F4	3

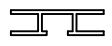

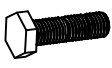
DEL	NR.	ANTAL
	P5	1
	14	1
	B5	3
	F4	5
	F6	3

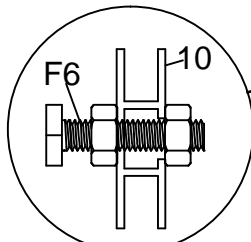
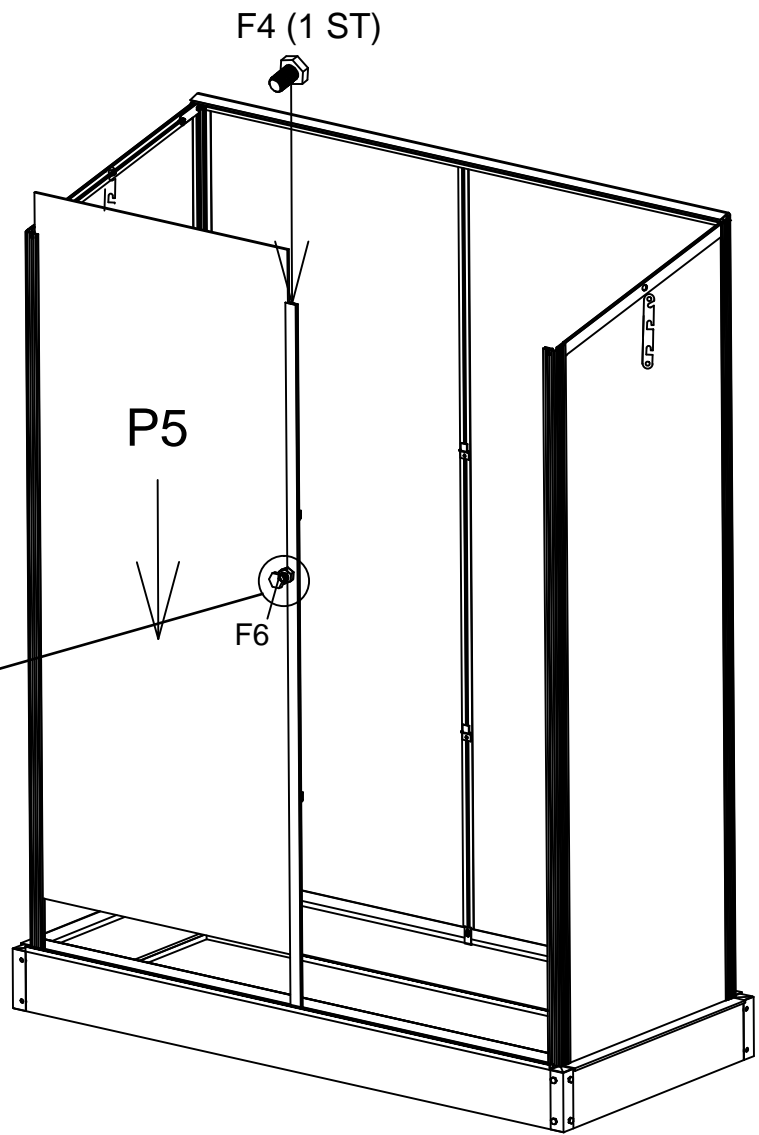



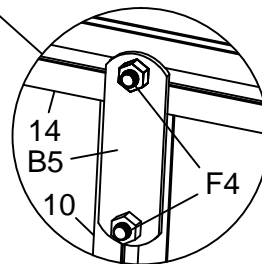
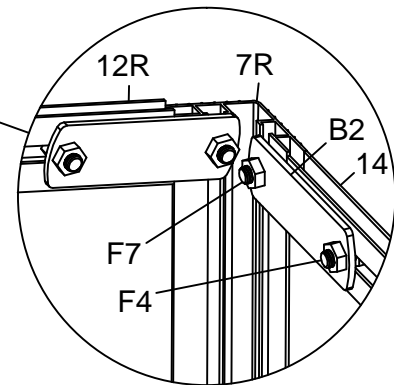
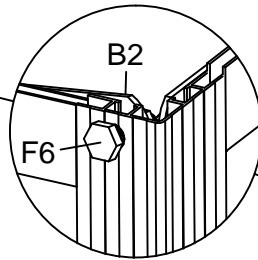
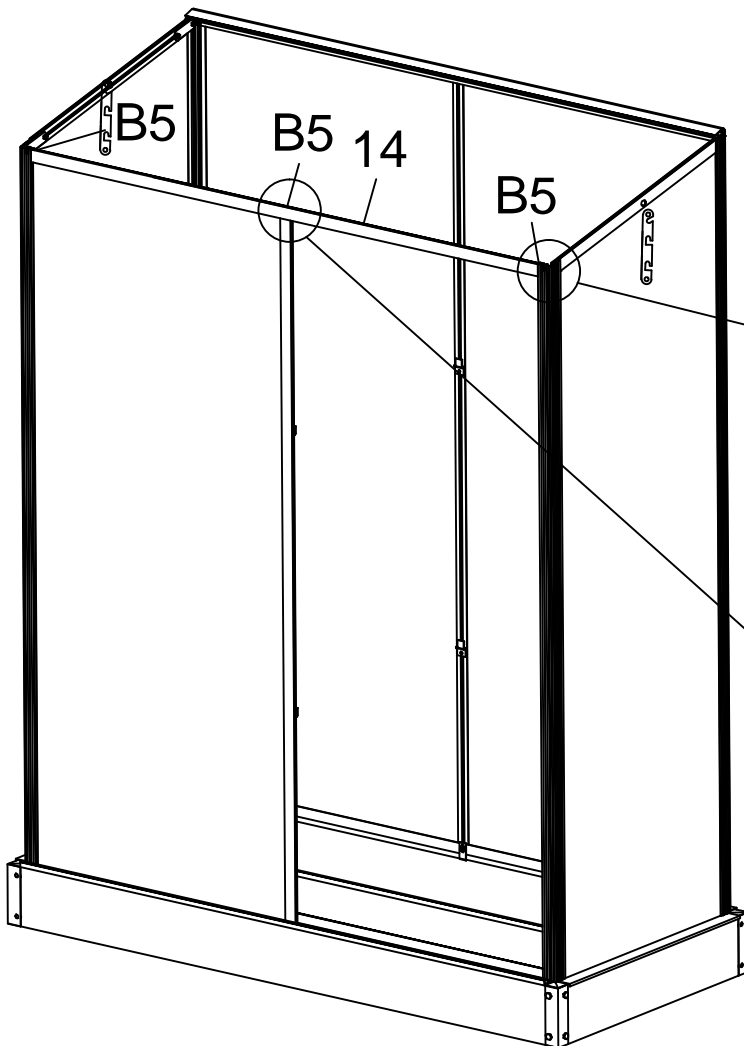

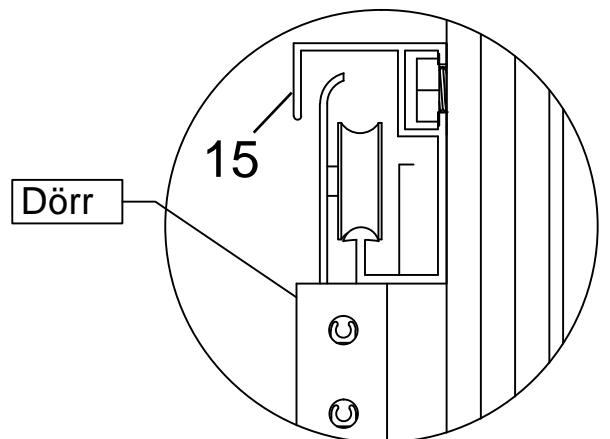
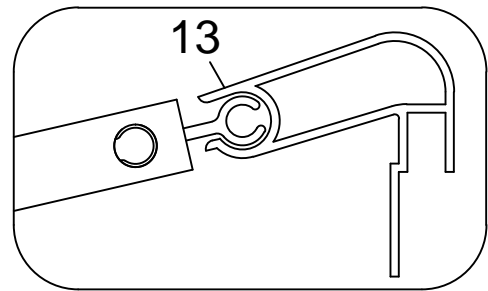
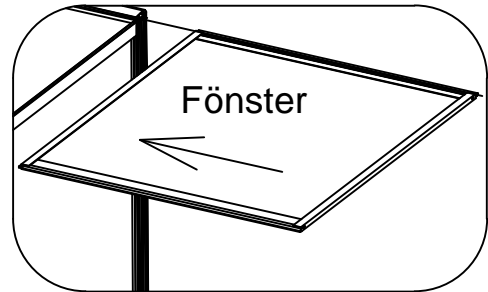
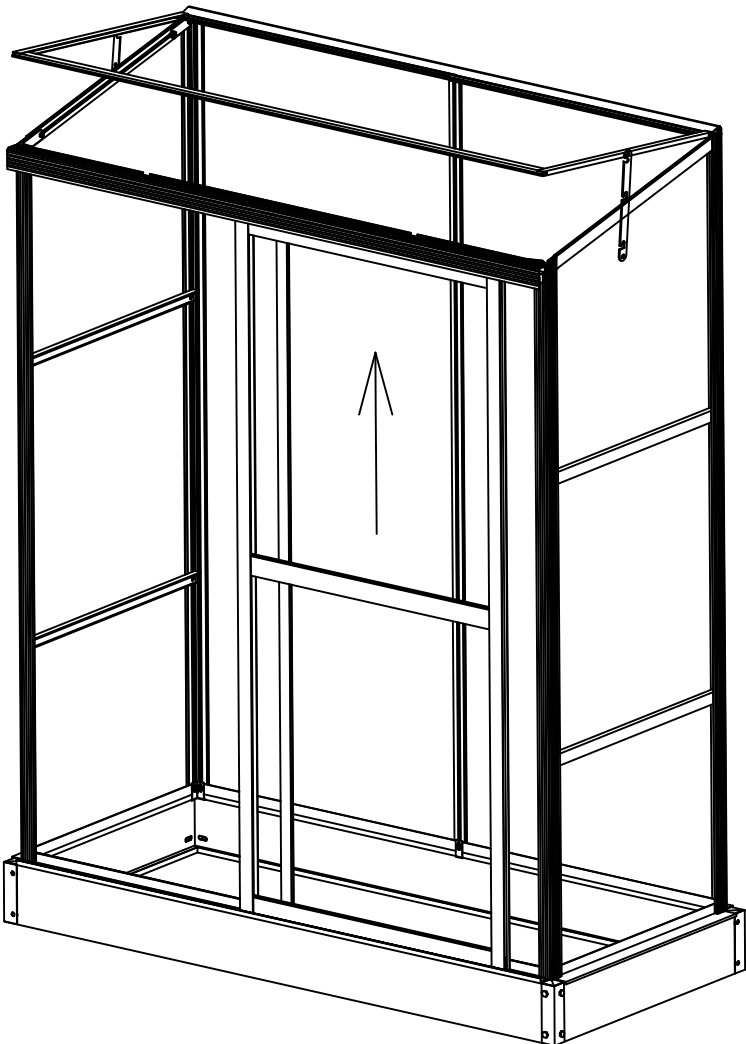
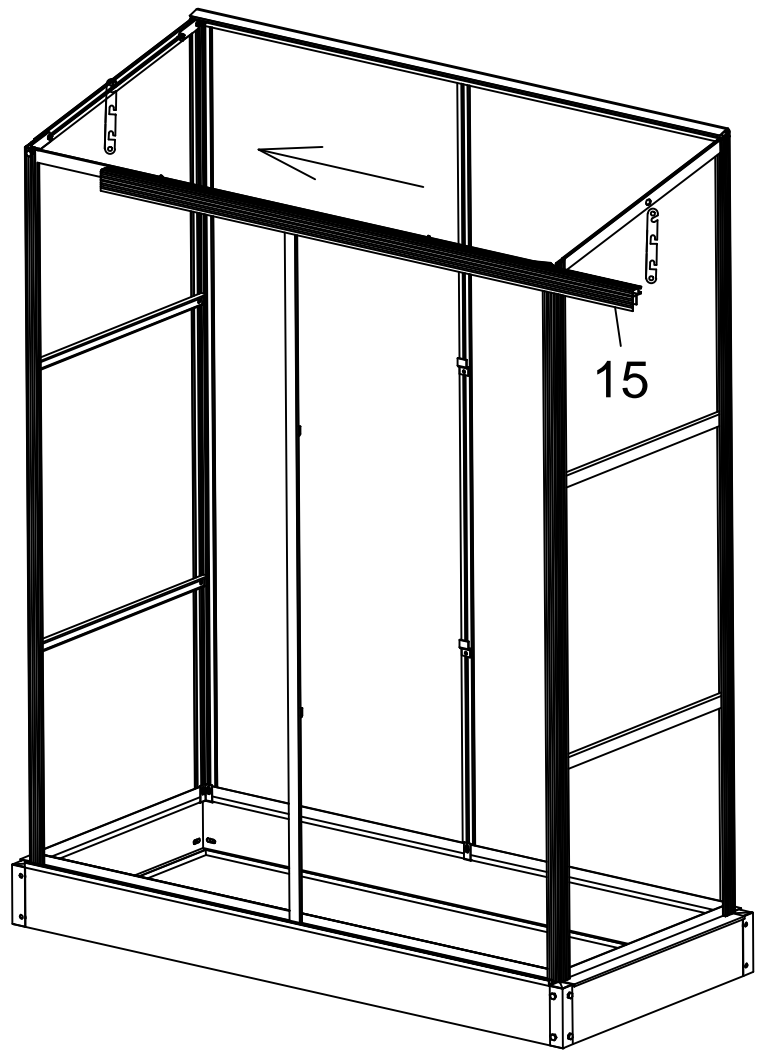
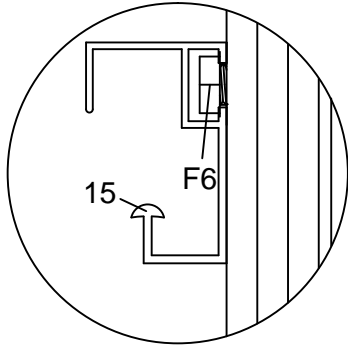

Dörrgräns









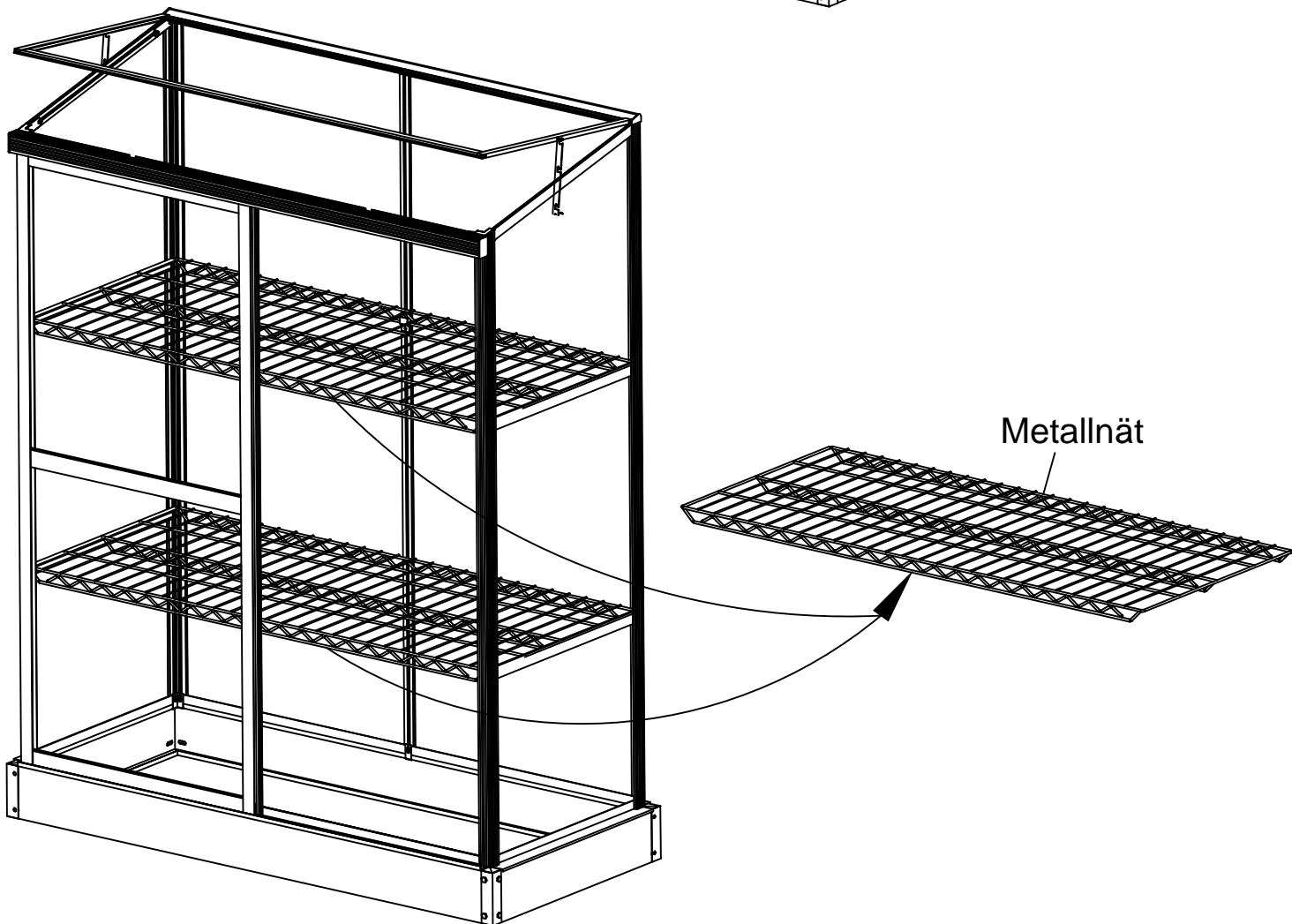
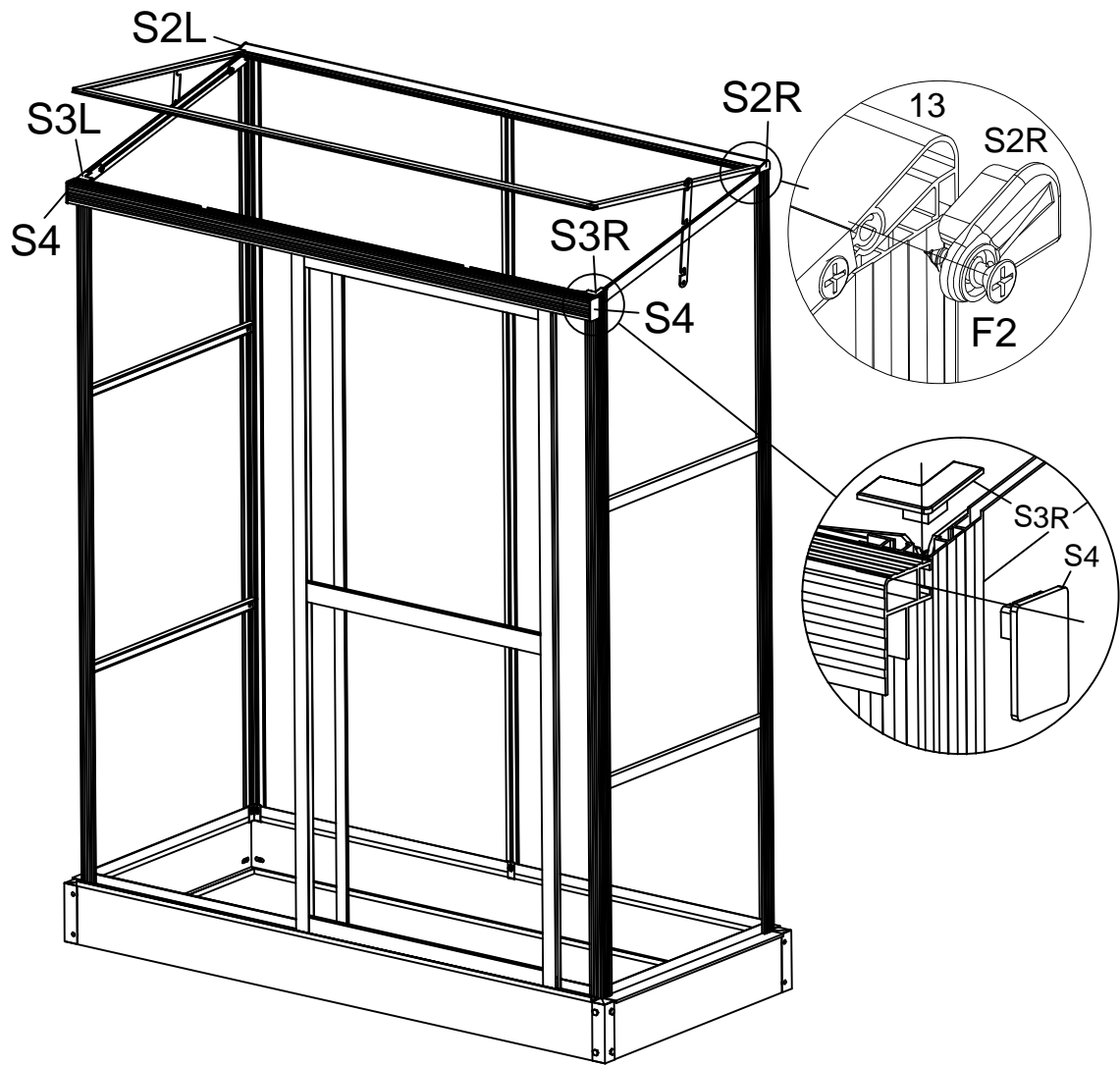

DEL	NR.	ANTAL
	15	1

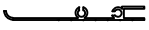

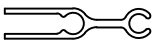

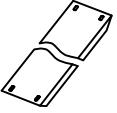

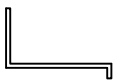

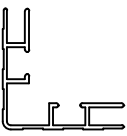
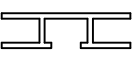



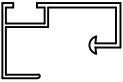
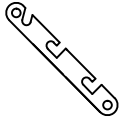

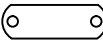
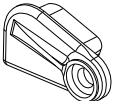
DEL	NR.	ANTAL
	S2L	1
	S2R	1
	S3R	1
	S3L	1
	S4	2
	F2	2

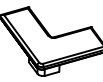

KOMPONENTLISTA

DEL	NR.	ANTAL
	D1	1
	D4	1
	D2	1
	D3	2
	W1	1
	W2	2
	W3	1
	1	2
	2	2
	3	4
	4	2
	5	1
	6	1
	7R	1
	7L	1
	8	2
	9	1
	10	1
	12R	1
	12L	1
	14	1

DEL	NR.	ANTAL
	11	4
	13	1
	15	1
	B2	2
	B3	10
	B4	4
	B5	7
	S2L	1
	S2R	1
	S3R	1
	S3L	1
	S4	2
	F1	8
	F2	8

DEL	NR.	ANTAL
	F7	16
	F4	38
	F6	5

POLYSKIVOR	P1	2
	P2	1
	P3	2
	P4R	1
	P4L	1
	P5	1