

FLOW NISCH 4D

8310

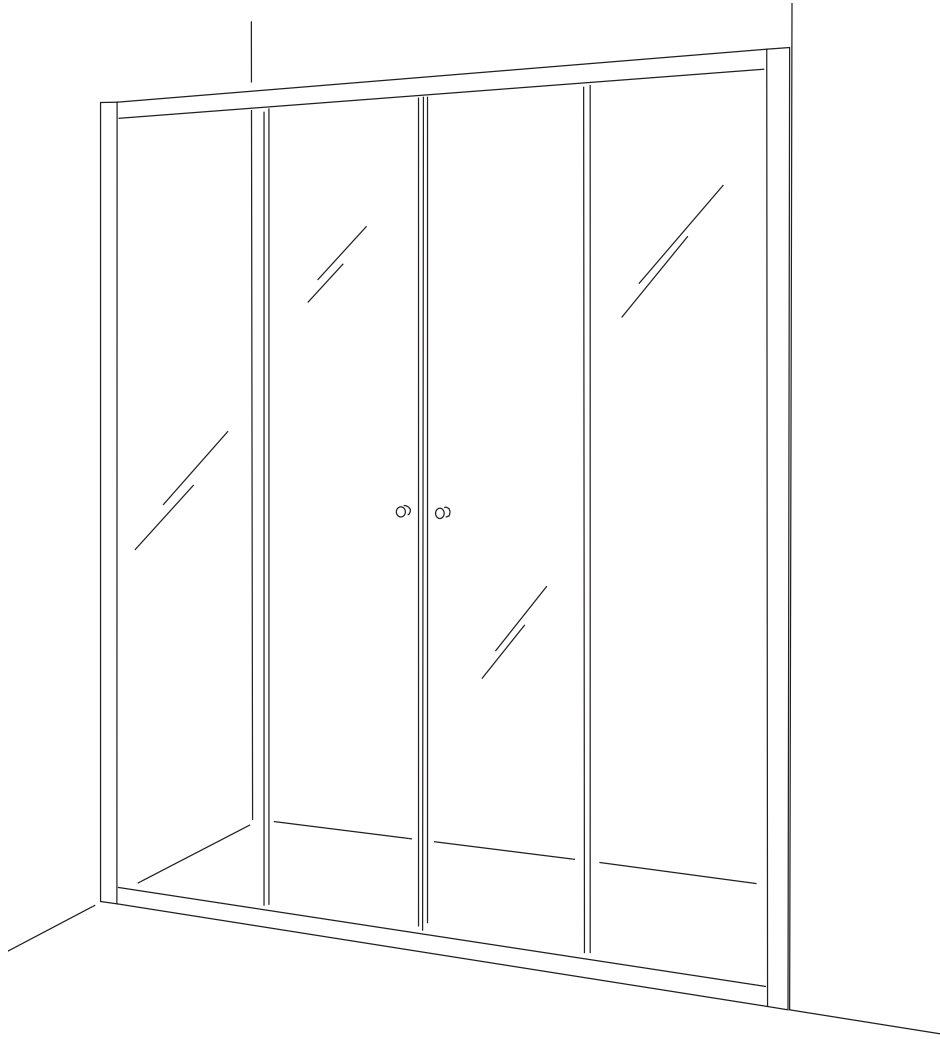

Macro Design®

FLOW NISCH 4D - MNF 4D

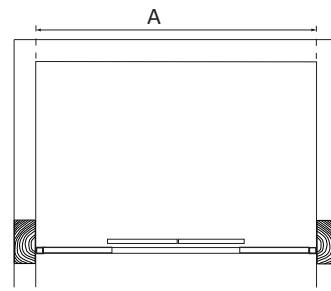
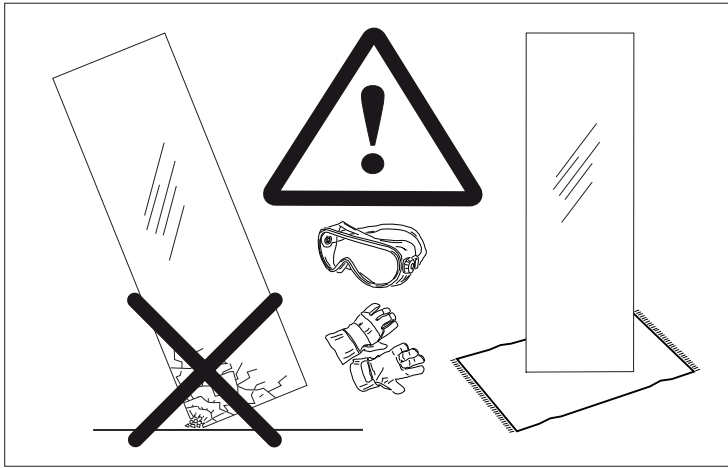

- A
- 1200 - 1250 mm
 - 1250 - 1300 mm
 - 1300 - 1350 mm
 - 1350 - 1400 mm
 - 1400 - 1450 mm
 - 1450 - 1500 mm
 - 1550 - 1600 mm

mått anges i yttermått

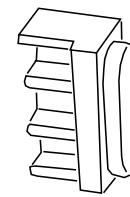
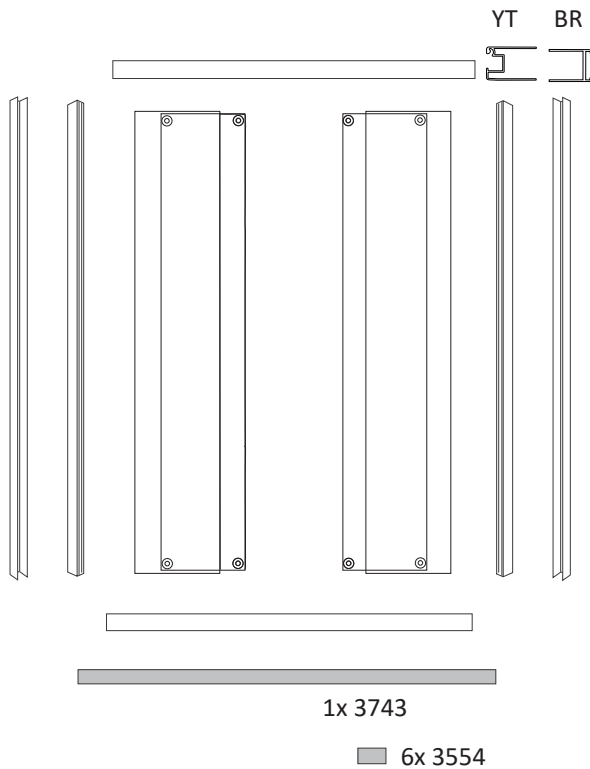

4x
2869



4x
3094 - 3,9 x 19



4x
3008 - 3,9 x 9,5

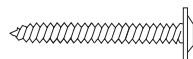

4x
3095 - 4,2 x 38



4x
2525 / 2520



1x
Art. 8000

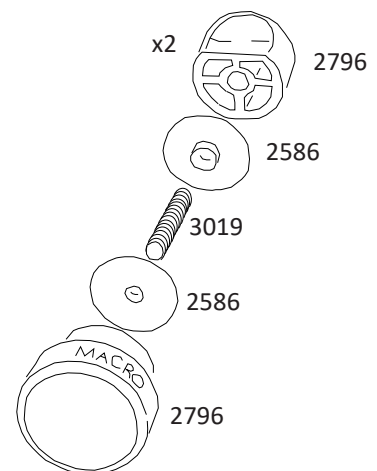

1.

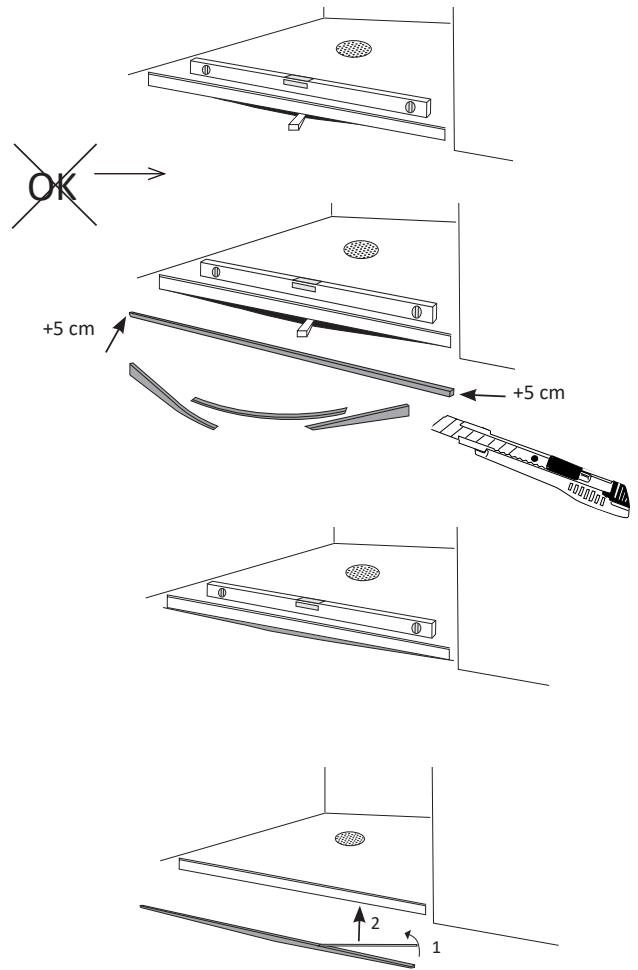
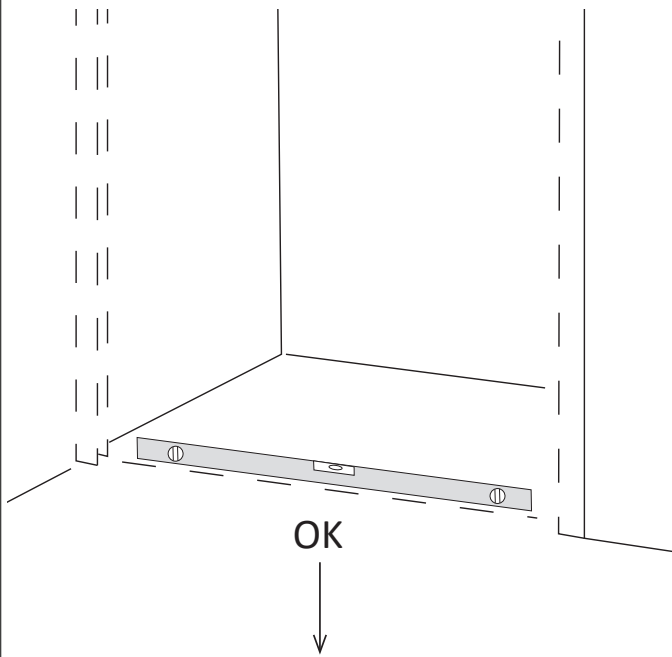

2.

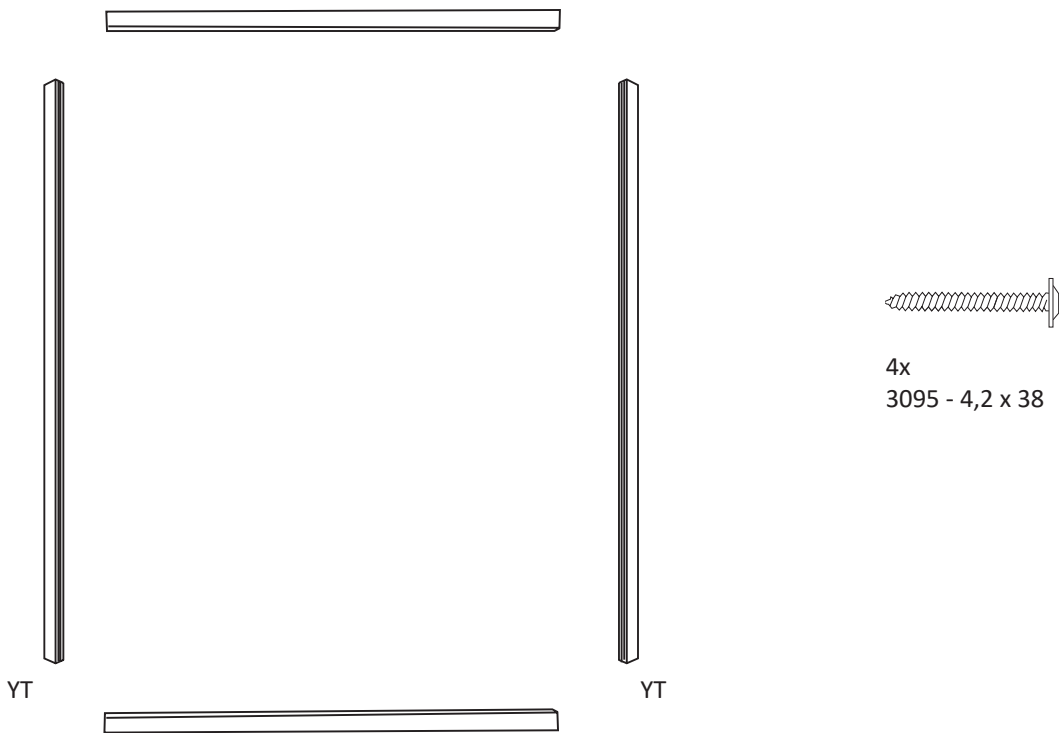

3.

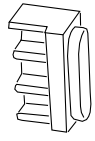

4x
2869

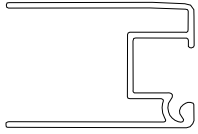

YT

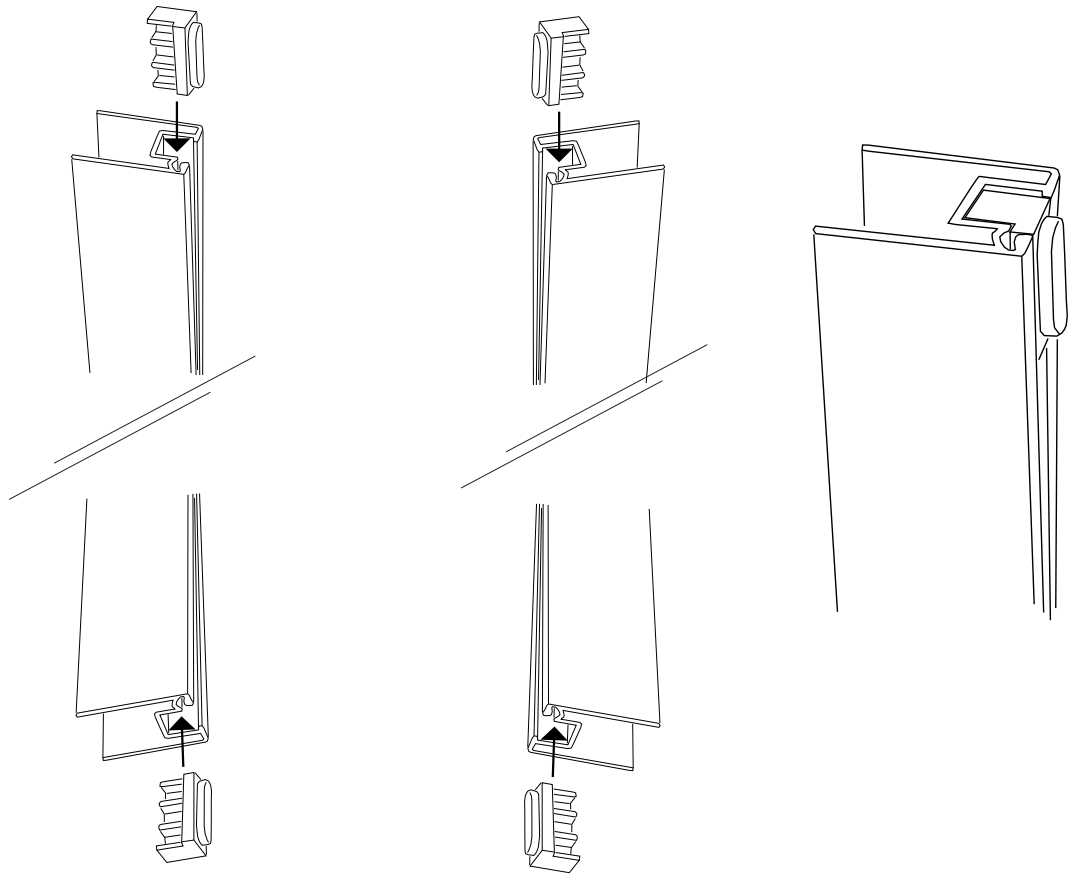

4.

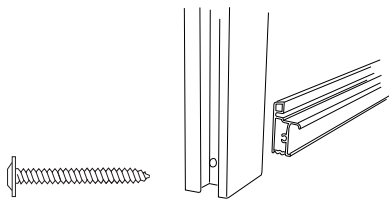

3095 - 4,2 x 38

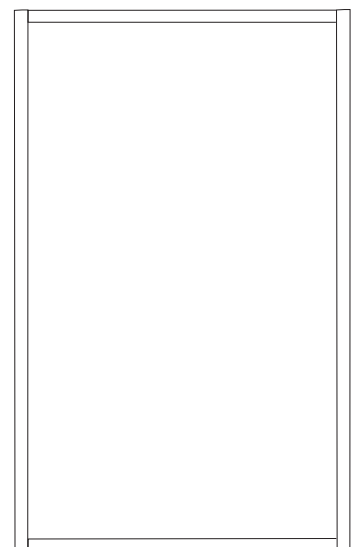
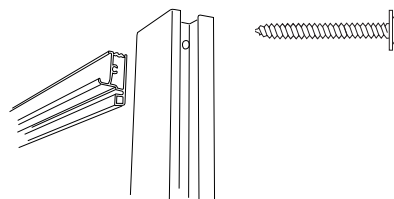
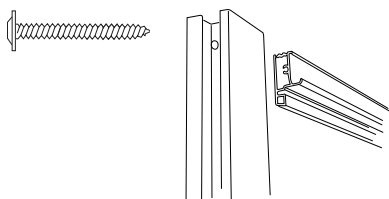
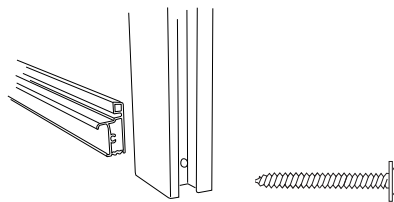

5.

3094 - 3,9 x 19

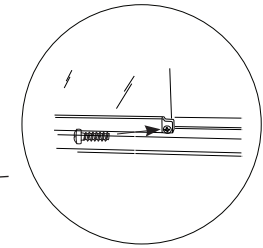
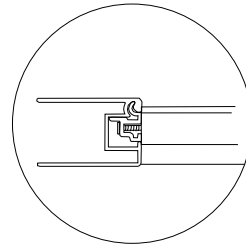
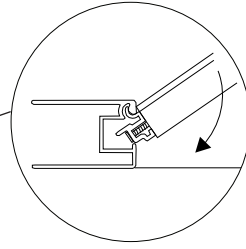
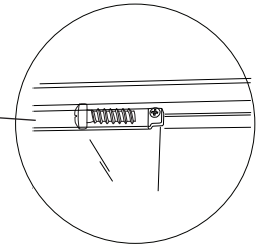
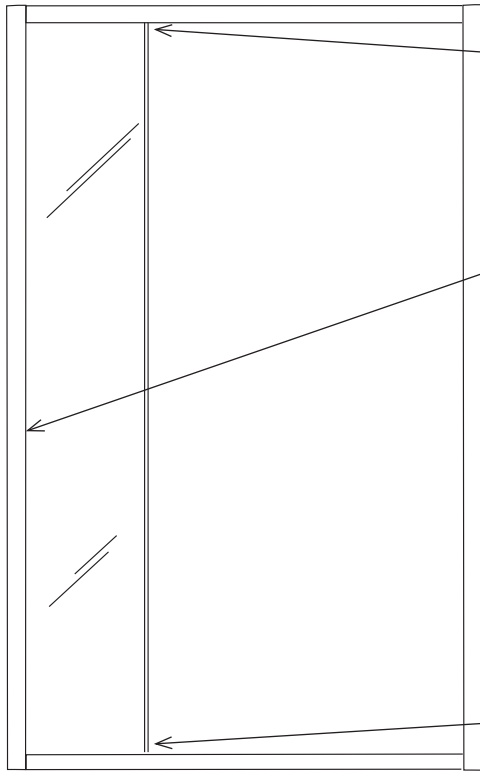

3094 - 3,9 x 19

6.

3094 - 3,9 x 19

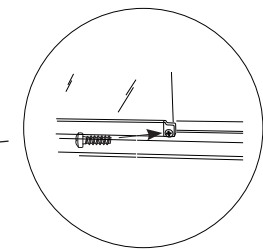
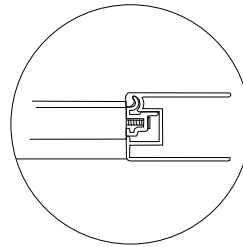
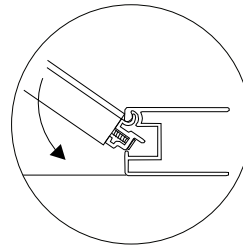
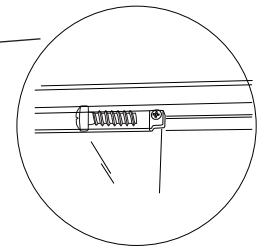
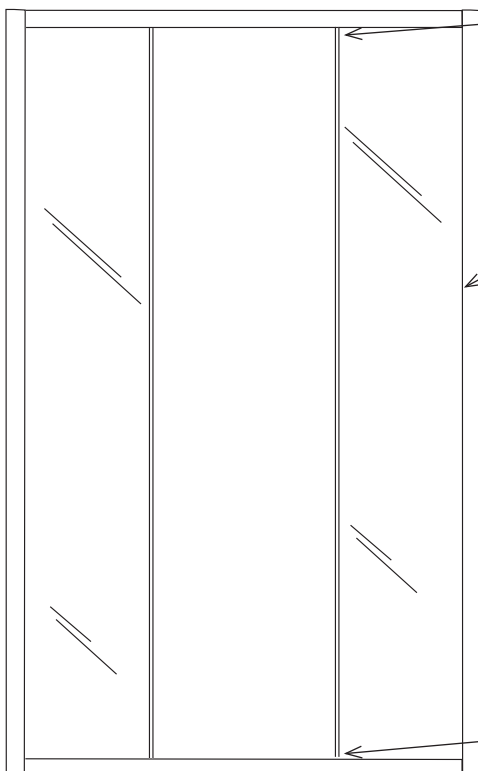

3094 - 3,9 x 19

7.

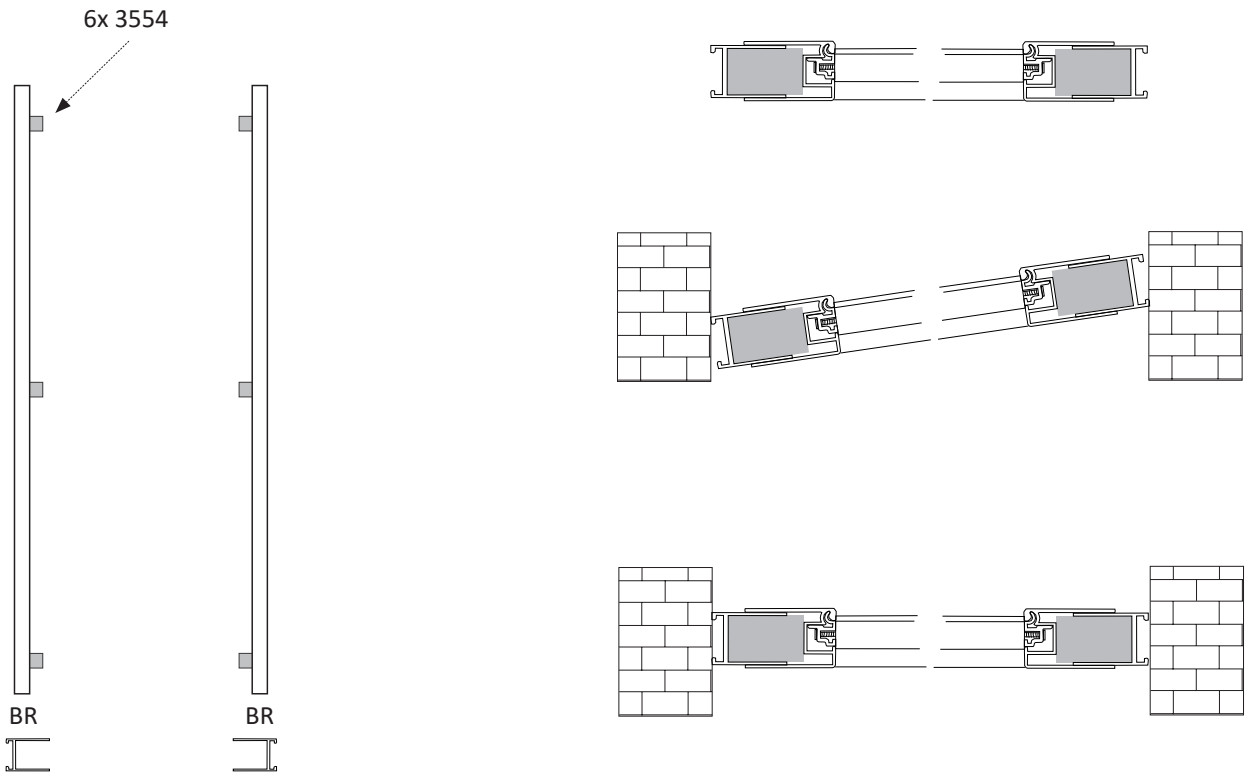

8.

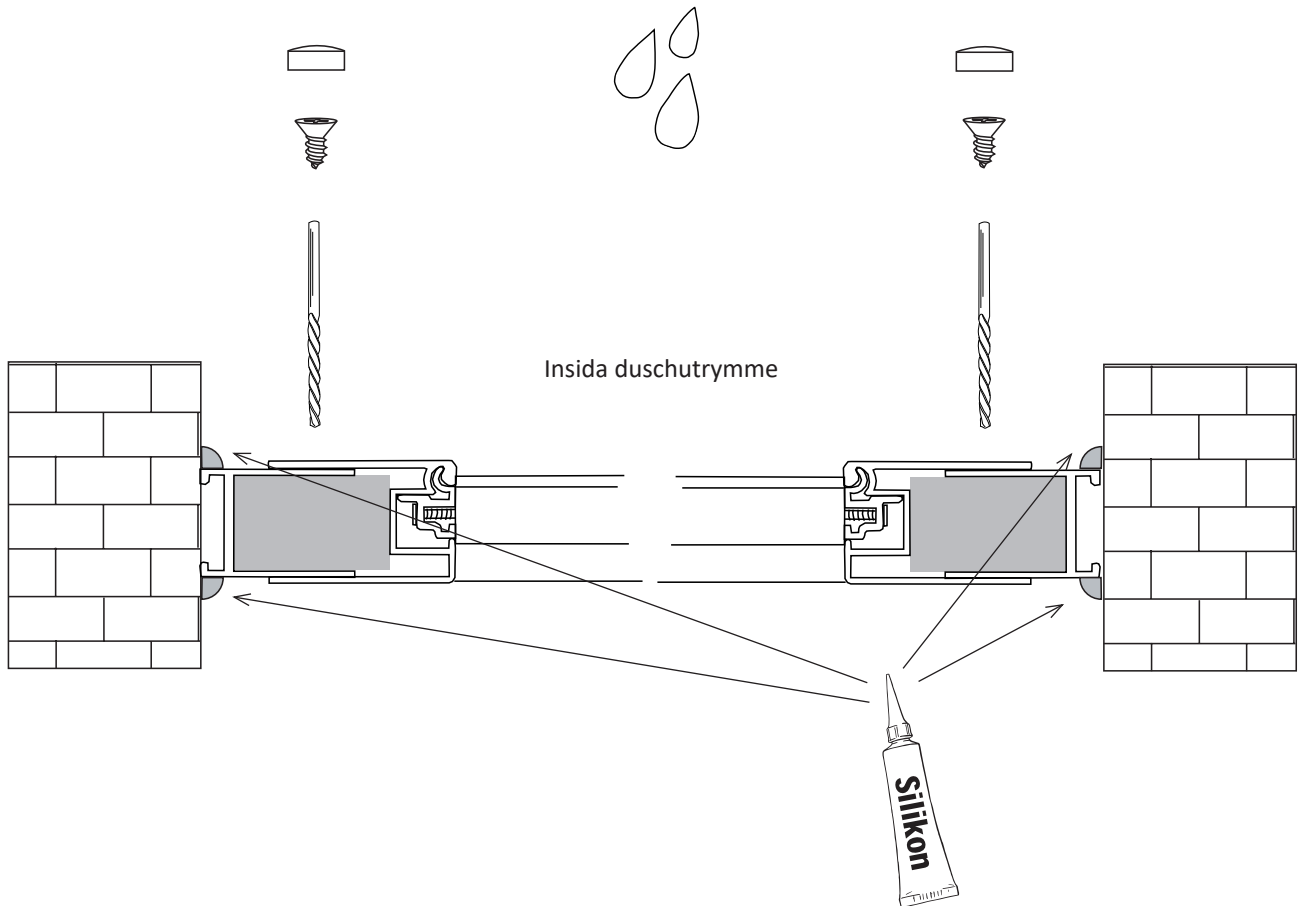

9.

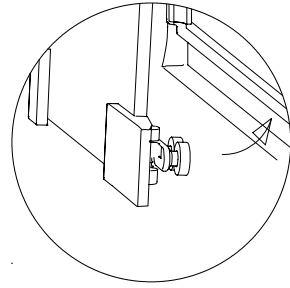
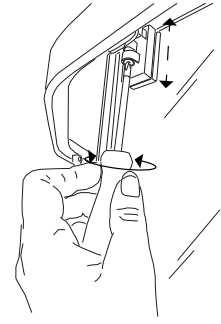
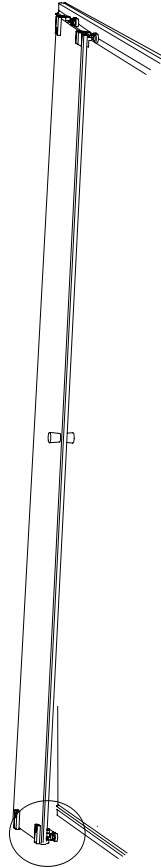
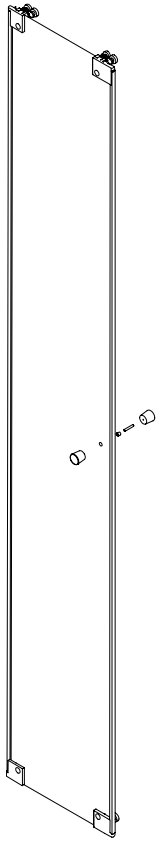

10.

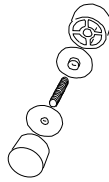
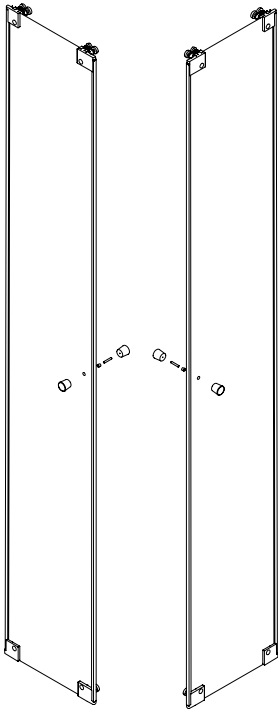

11.

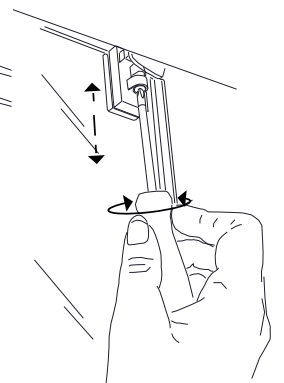
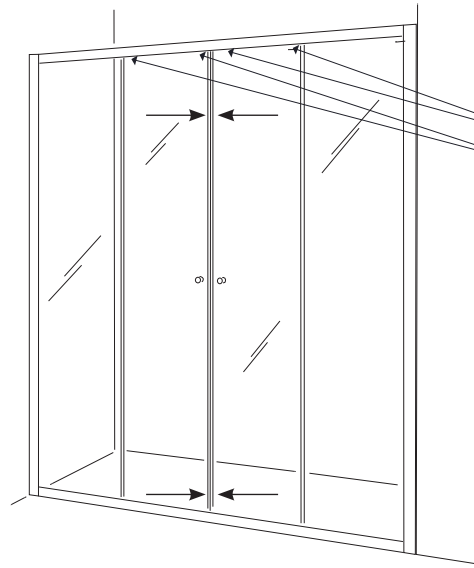

TACK FÖR ATT DU VALDE EN PRODUKT FRÅN MACRO DESIGN

Macro Design är ett svenskt företag som tillverkar duschar, badrumsmöbler och badrumstillbehör. När du väljer en produkt från Macro Design så vet du att du har gjort ett tryggt köp, har generösa garantier och din produkt kommer att hålla i många år framöver. För att hålla dina produkter i toppskick är det även viktigt att du vårdar och rengör dem regelbundet enligt anvisningarna.

Skötselråd för duschar

Glas

Effektivaste och även det miljövänligaste sättet att hålla glaset rena och fina är att efter varje dusch dra med en gummiskrapa. Rengör glaset minst varannan vecka med diskmedel eller mildt ättikbaserat rengöringsmedel. Använd svamp eller borste som inte repar glaset eller profilerna.

Mönstrade glas

Screenmönster skall alltid vara på utsidan av glaset. Rengör utsidan med ljummet vatten och ett mildt diskmedel. Använd ej produkter som bildar en skyddshinna på glaset då dessa medel kan upplevas som flammiga eller som ett rinnmönster i screentrycket. Macro duschar får inte rengöras med medel som innehåller aromatiska kolväten, syror, ammoniak, natriumlut eller klorin.