

PLUS Plank



www.plus.dk

17778-1 / 17778-15

17779-1 / 17779-15

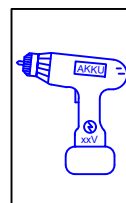
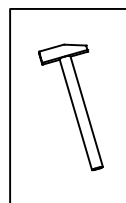
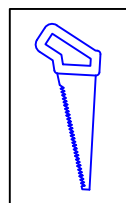
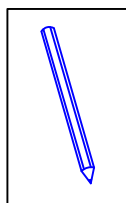
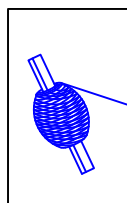
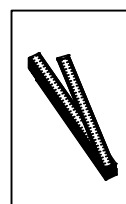
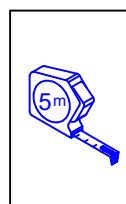
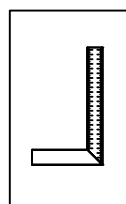
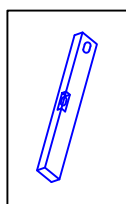
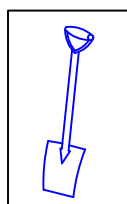

Medfølger ikke

17750-1
Skruepose

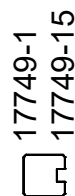
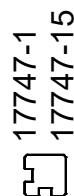
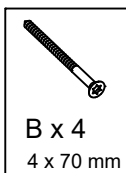
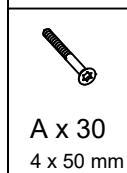

Stolper

17743-1
17743-15



17760-1
17760-15

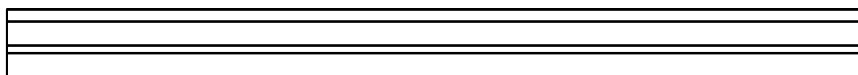

Se montagevideo på www.plus.dk

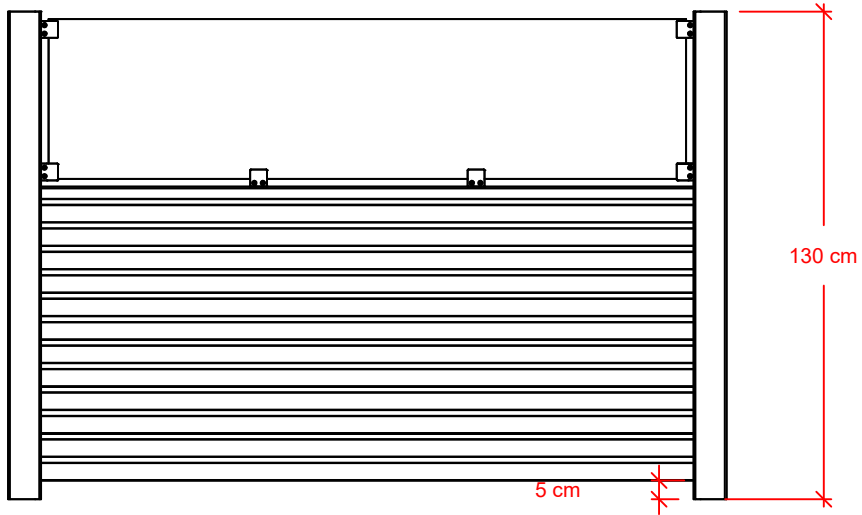

17778-1 / 15

6 planker

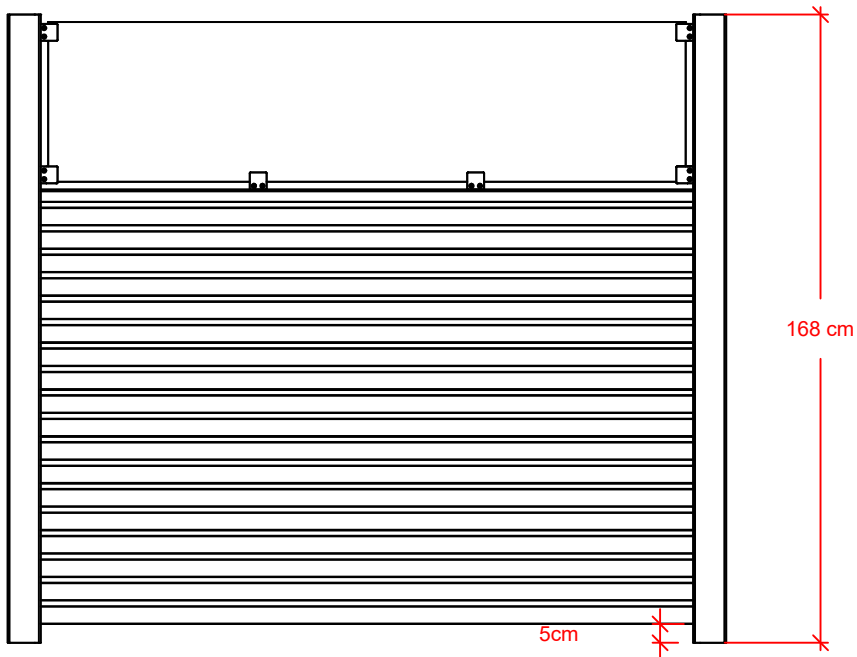

17779-1 / 15

9 planker



Stolper nedgraves 90 cm.

Efter nedgravning af stolper, og før fastskruing af det første bræt. Trækkes der en snor, så man sikrer at brædderne passer ud for hinanden.



Sørg for at nederste planke er fri af terræn. Det vil være en god ide, med ca. 5 cm under det nederste bræt til terræn. (læg evt. en træklods som på billede 1.)

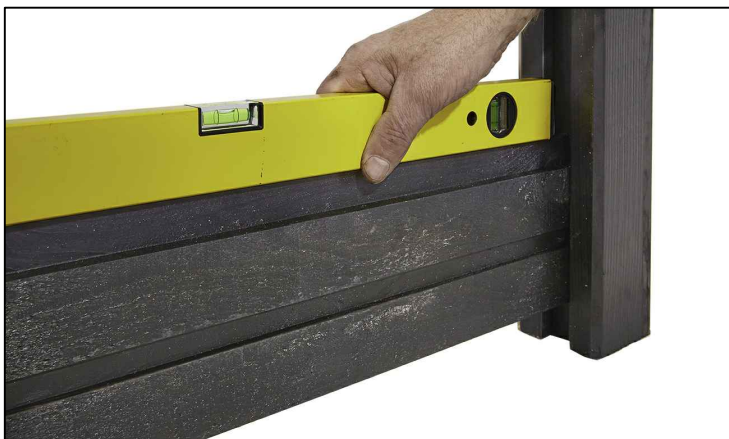

Tjek med vaterpas at brættet er i vatter.



Herefter kan det nederste bræt skrues fast. Med 2 skruer i hver ende. (Skrues skråt ind ved stolpen).

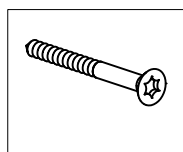

6 planker

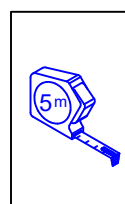
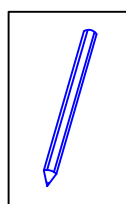
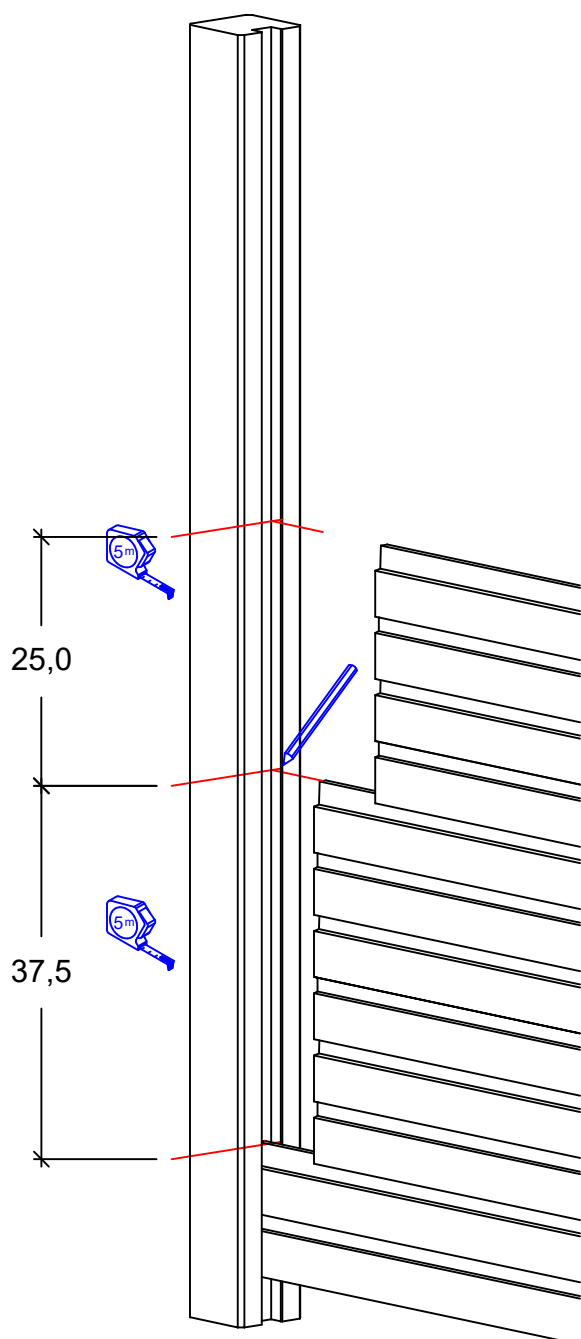

Nederste planke fastskrues.

Mål og markør på stolpen, placering af de næste 3 planker. (37,5 cm).

Fortsæt monteringen af de øvrige brædder, dog kun med 3 stk. af gangen, så der er mulighed for justering/jævn fordeling inden de fastskrues.

Se også billedserie.

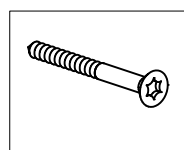

9 planker

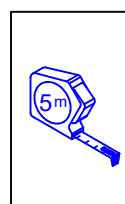
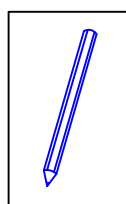
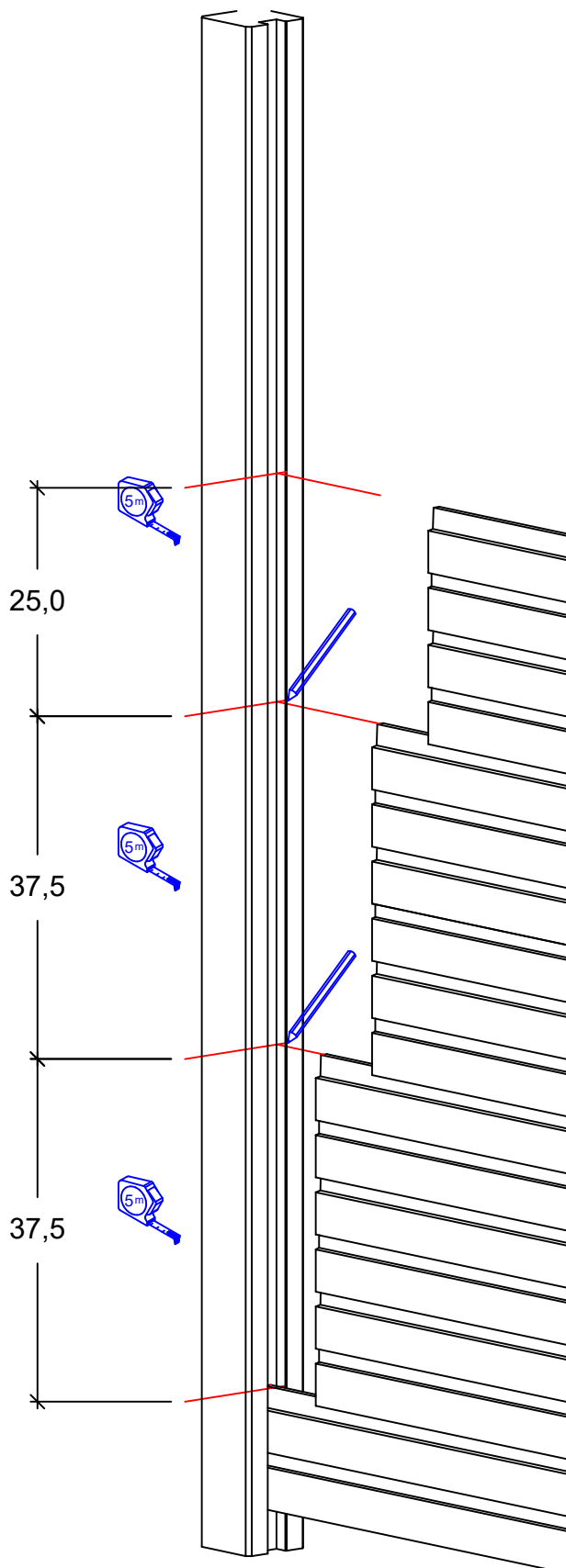

Nederste planke fastskrues.

Mål og markør på stolpen, placering af de næste 3 planker. (37,5 cm).

Fortsæt monteringen af de øvrige brædder, dog kun med 3 stk. af gangen, så der er mulighed for justering/jævn fordeling inden de fastskrues.

Se også billedserie

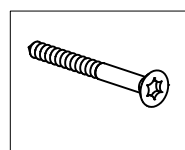



Spor passer ikke ud for hinanden.

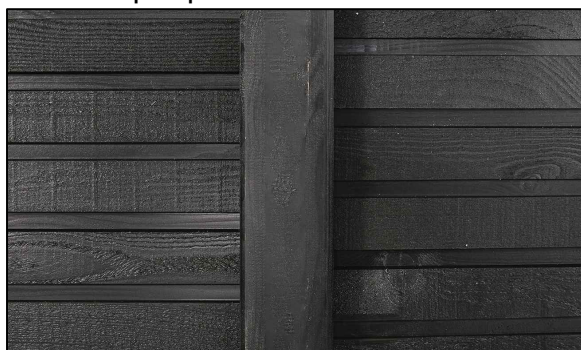

Spor passer ud for hinanden.

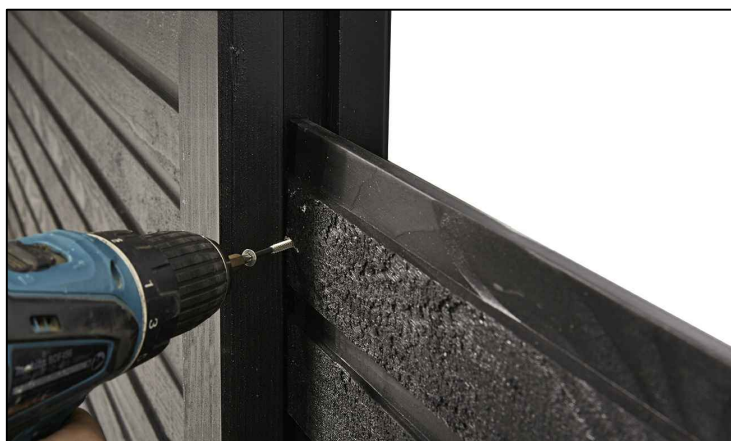
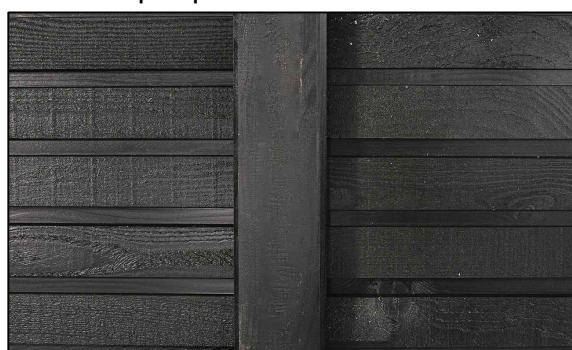

Fastgørelse af brædder.
1 skrue i hver side.

(Bortset fra bund og top bræt, de fastgøres med 2 skruer i hver side).



Stolpen afsaves så den passer med
højden på hegns brædder.
Fer på øverste bræt skal kunne
passe op i not på toplisten.

Brædder og stolper er fra fabrikken Trykimprægneret -1 og (-15 er derefter grundmalet sort). Pga. fugtindholdet i træet på produktionstidspunktet vil imprægneringen primært blive optaget i overfladen.

For at forlænge holdbarheden, er det derfor hensigtsmæssigt at efterbehandle produkterne med træpleje.

Venligst bemærk:

Egenskaber og karakteristika, der er typiske for træ som:

Revnedannelse i overfladen. Kan fyldes med en egnet spartelmasse.

- Harpikslommer/harpiksudtræk
- Knasthuller er også en naturlig bestanddel i træ.
- Træ er et naturprodukt

Ovennævnte reducerer ikke træets kvalitet og berettiger derfor ikke til reklamation.

Spørg din lokale farveekspert om efterbehandling.

Gem denne vejledning til senere brug.

Se www.plus.dk for yderligere information vedr. vedligehold.

17522-1

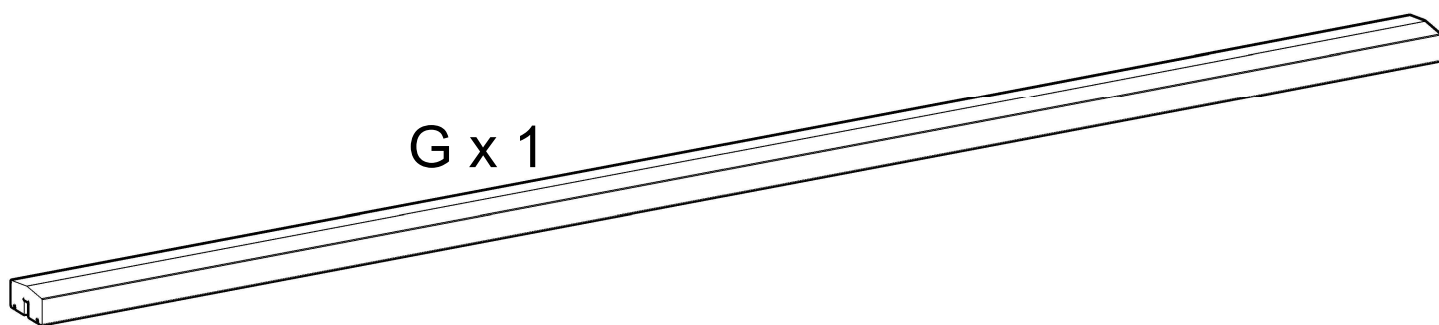
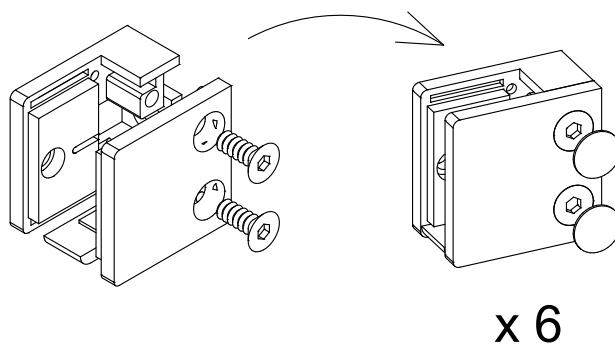
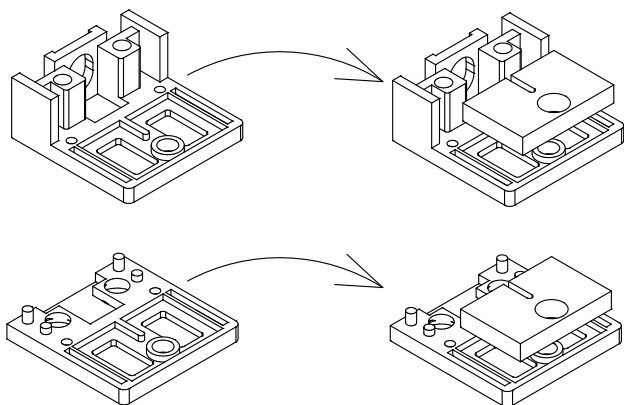
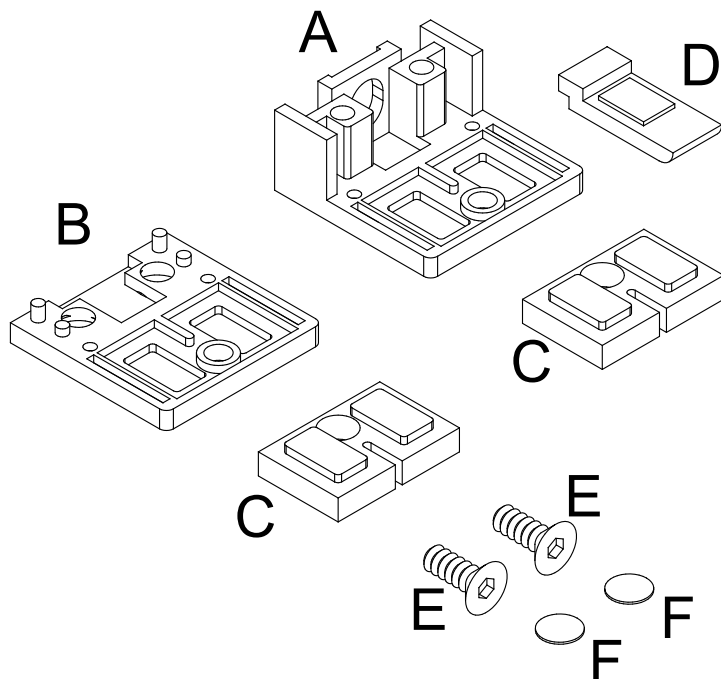
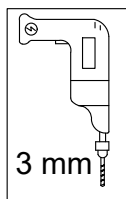
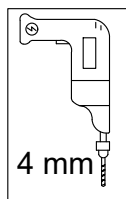
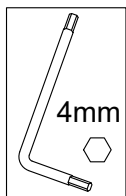
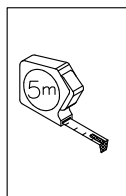
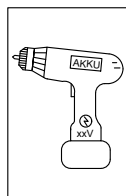

H x 2

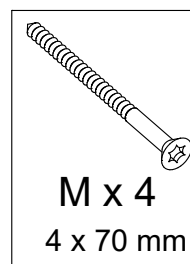
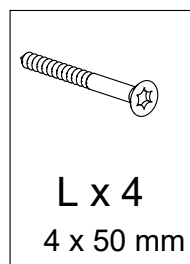
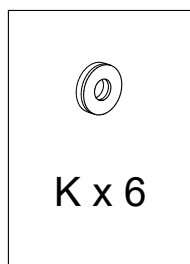
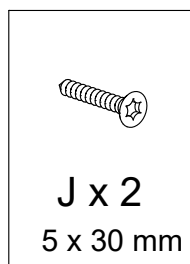
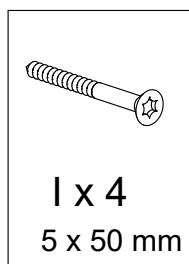

PLUS Klink

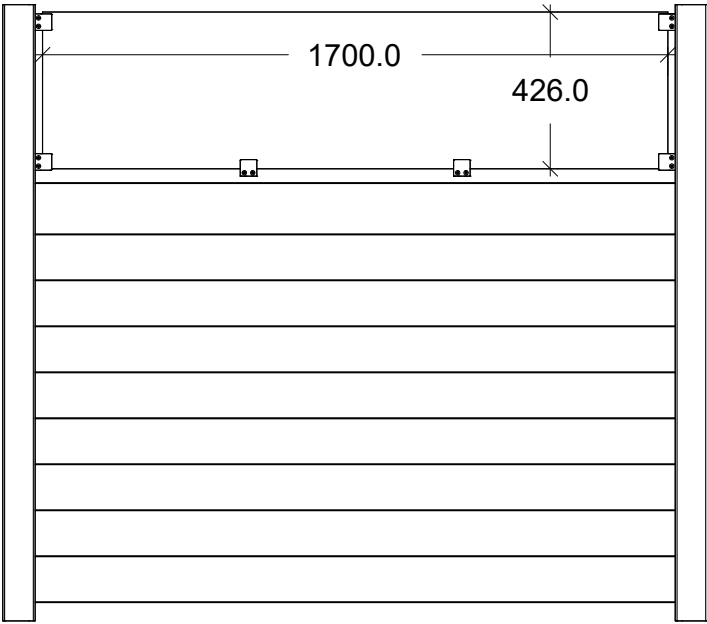

17799-1 / 15

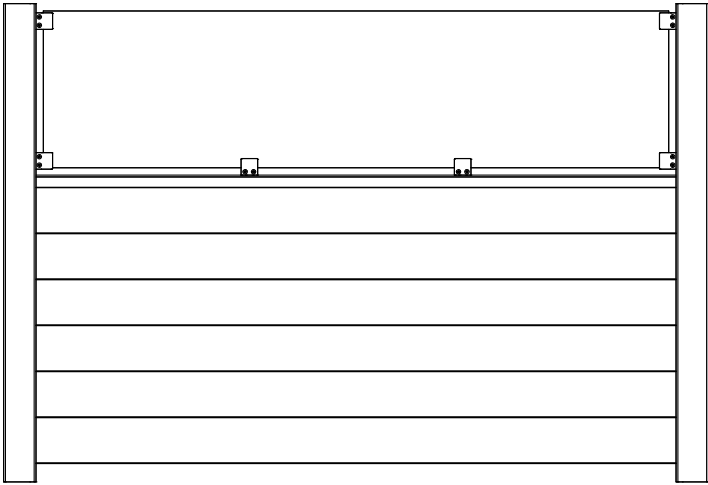

17798-1 / 15

PLUS Plank

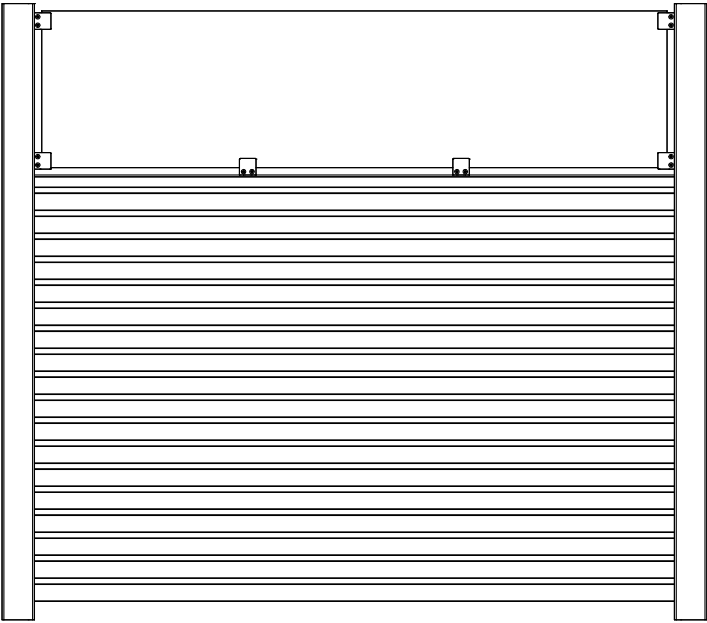

17779-1 / 15

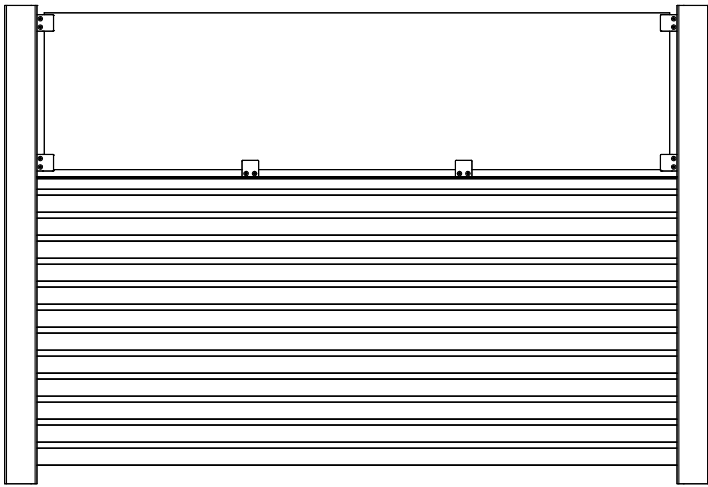

17778-1 / 15

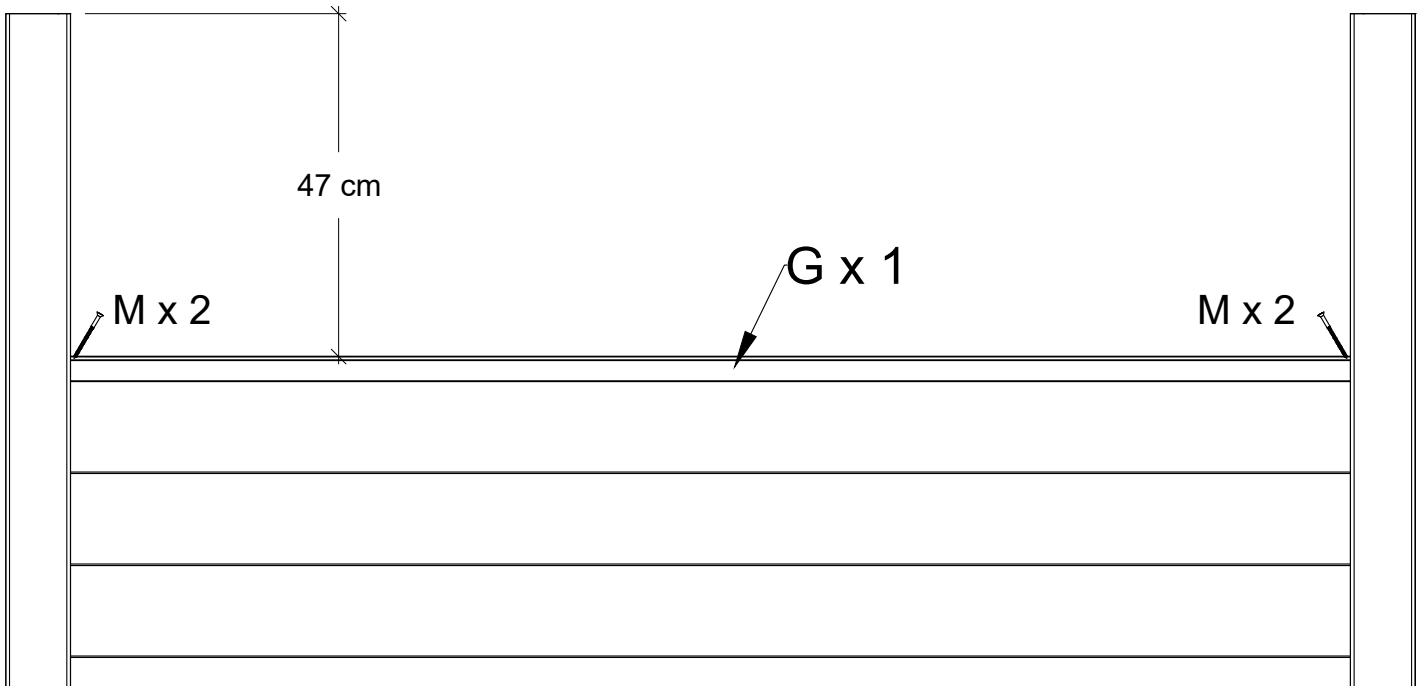
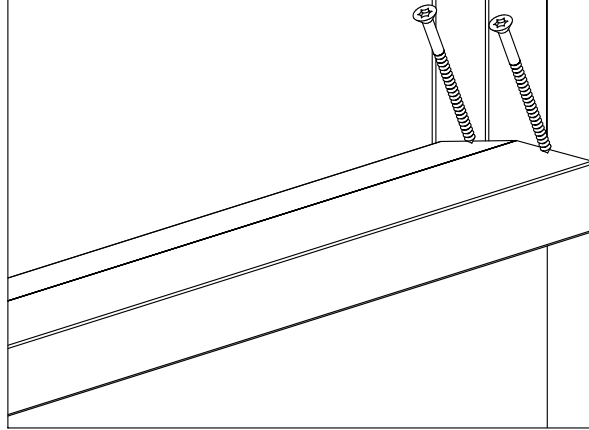
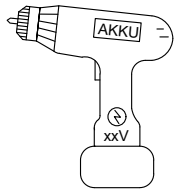
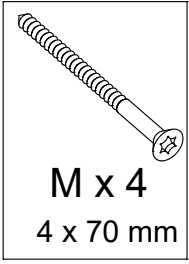

1.

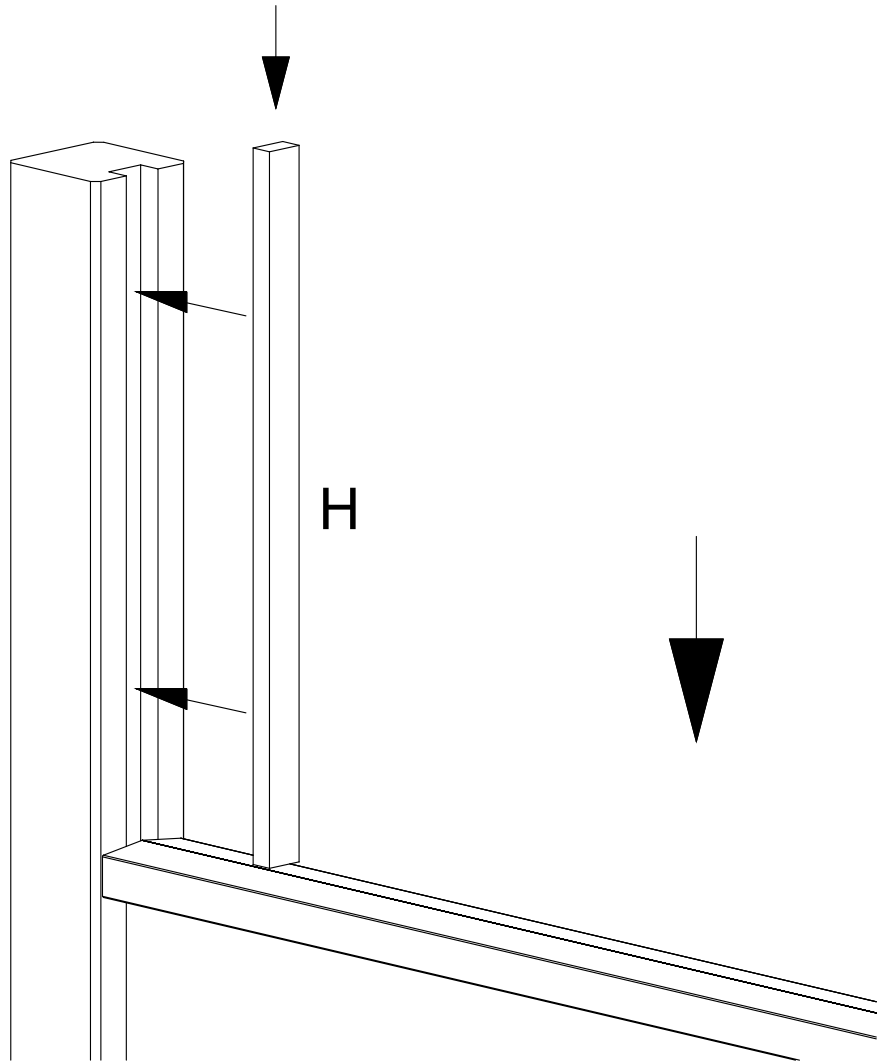

2.

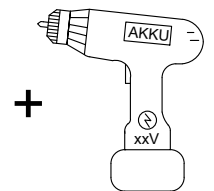
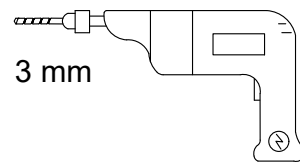
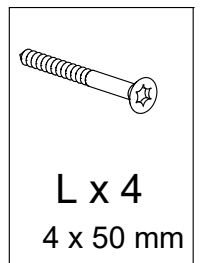
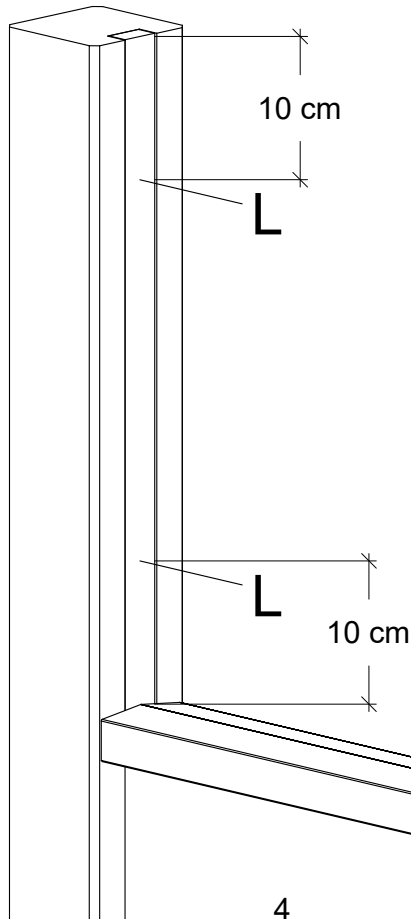

Forbores med 3 mm bor.

Pre-drill with a 3 mm drill.

Vorbohren mit einem
3 mm Bohr.

Drill foret de 3 mm.

Förborra med en 3 mm borrh.

Forbores med et 3 mm bor.

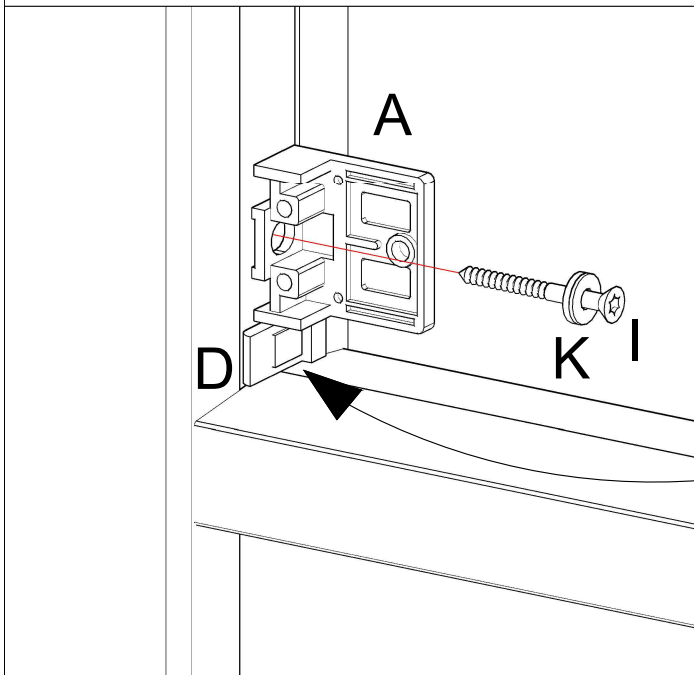
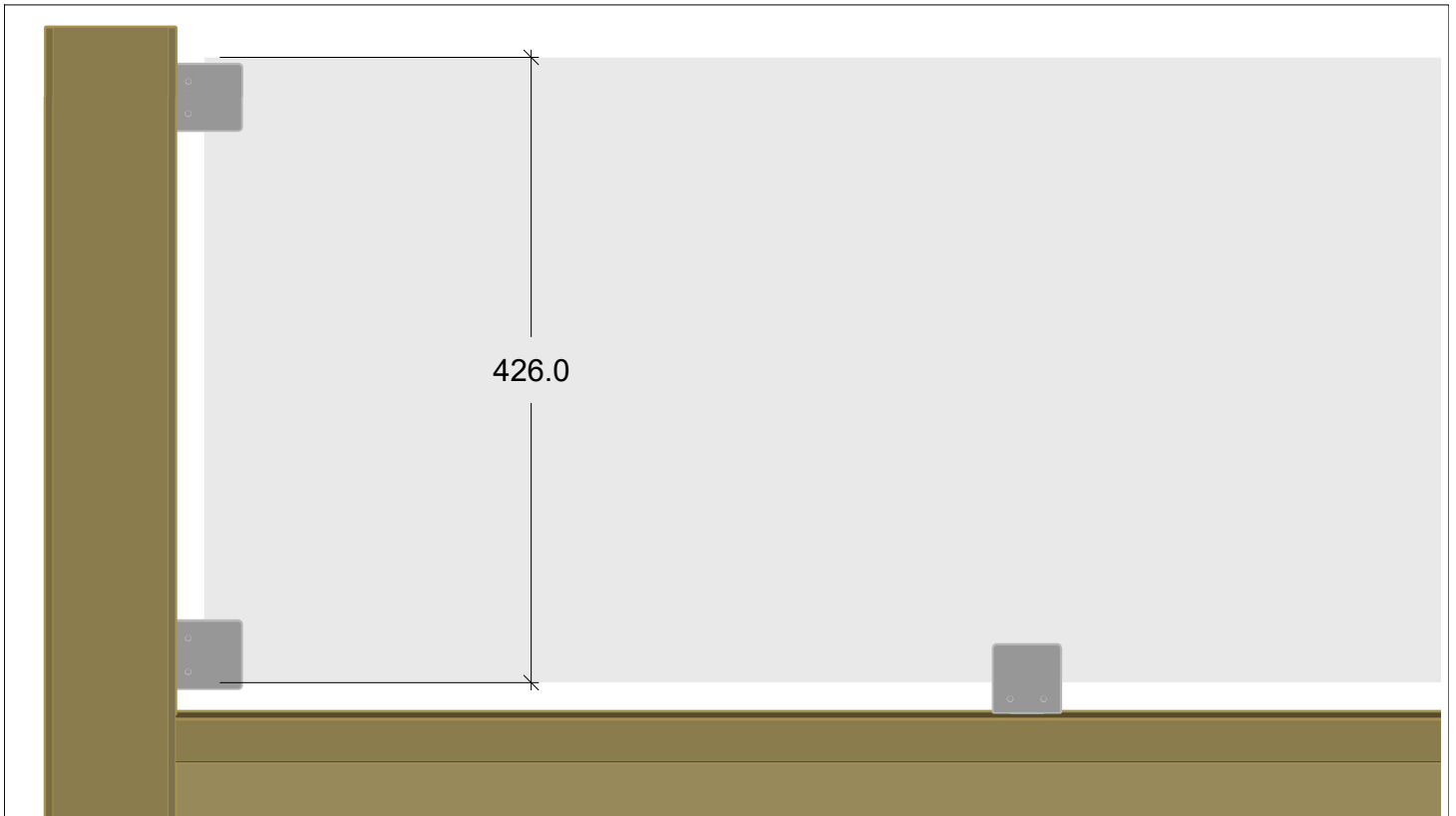

Bundplade
 Base plate
 Grundplatte
 Plaque du fond
 Bottenplatta
 Bunnplade

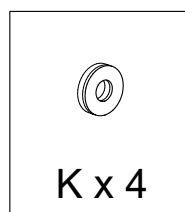
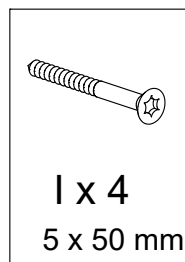
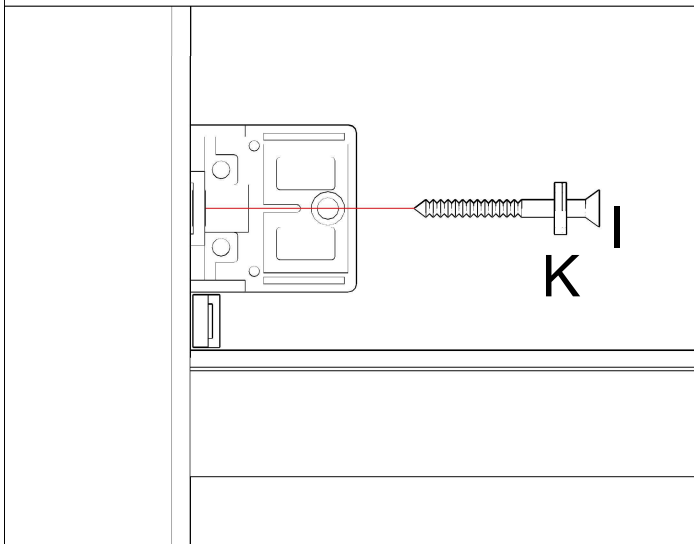
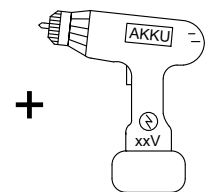
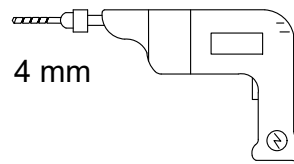
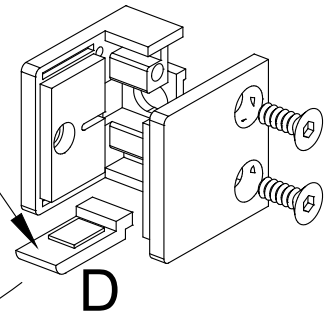

Forbores med 4 mm bor.

Pre-drill with a 4 mm drill.

Vorboren mit einem 4 mm Bohr.

Drill foret de 4 mm.

Förborra med en 4 mm borr.

Forbores med et 4 mm bor.

