

Fig. 2

Fig. 1

Fig. 3

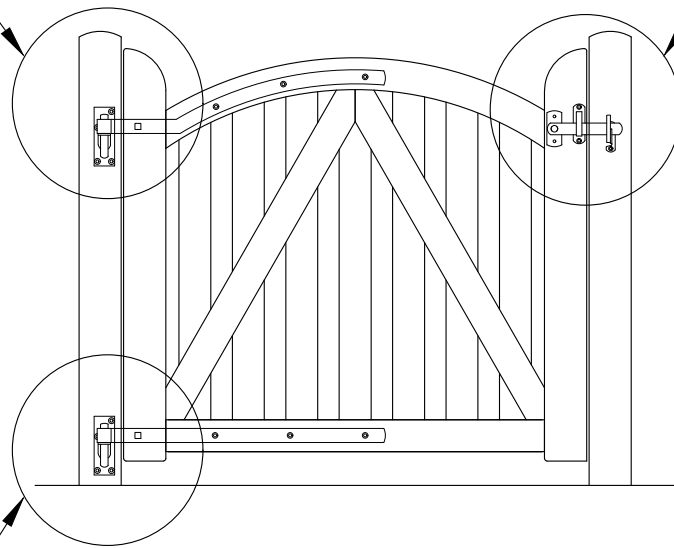

Fig. 2

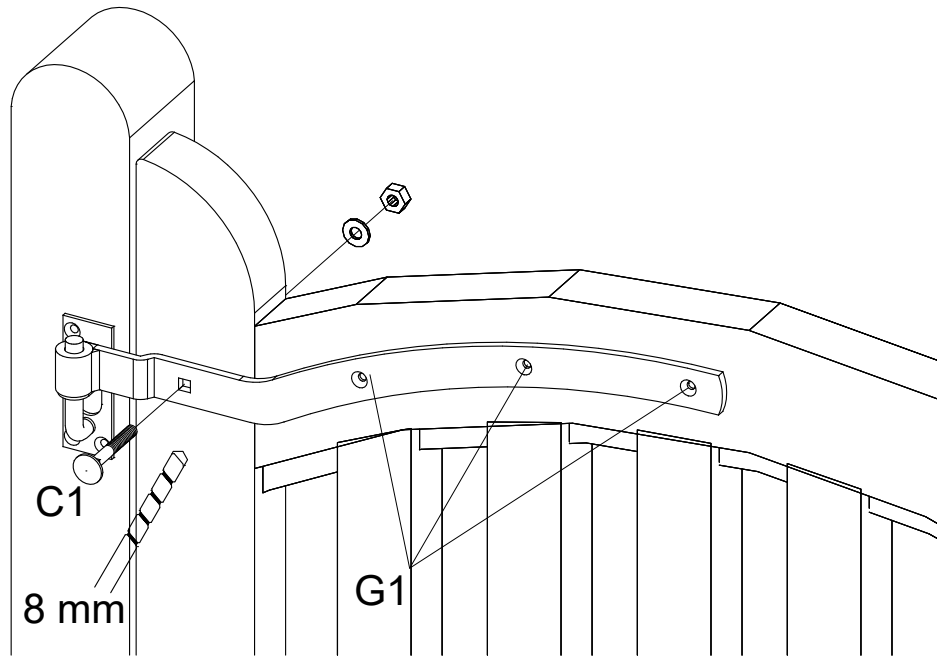

Fig. 3

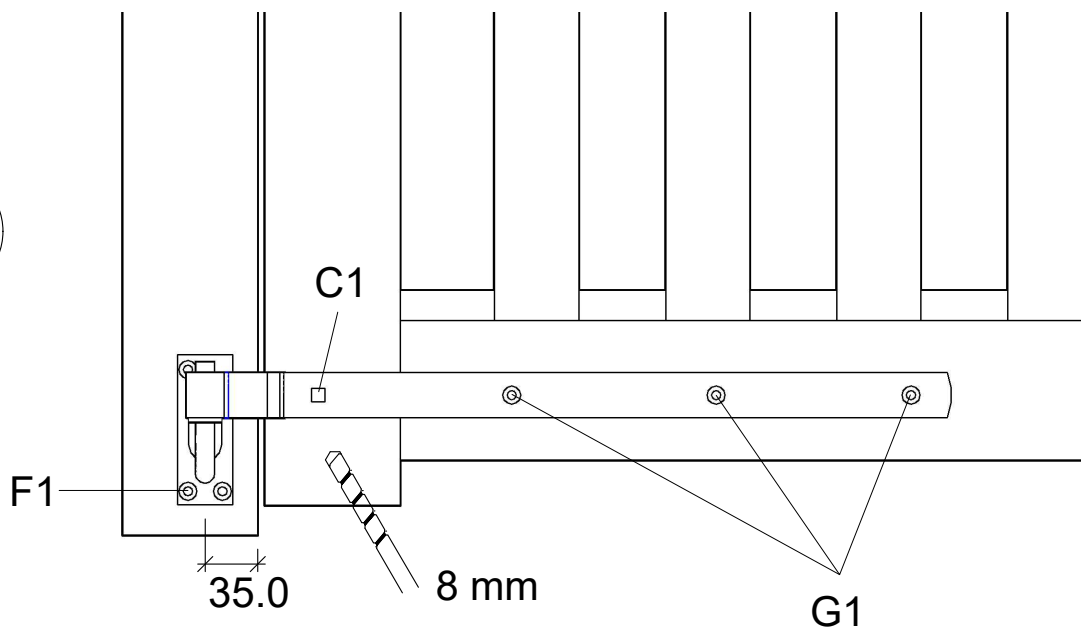

Fig. 2

Fig. 1

Fig. 3

