

## MANUAL TUNNELVÄXTHUS PV-103

















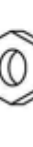

Obs:

1. Följ monteringsanvisningarna noggrant.
2. 2–3 personer krävs för monteringen.
3. För maximal stabilitet för tunnelväxthuset bör ett dike grävas där basen placeras.

## Monteringsinstruktioner

### Komponentlista

#	1	2	3	4	5	6	7	8	9	10	11	12	13	14	15	16	
																	
	8 st	4 st	4 st	5 st	10 st	2 st	2 st	2 st	20 st	2 st	22 st	1 st	1 st	4 st	4 st	1 st	

### Steg 1

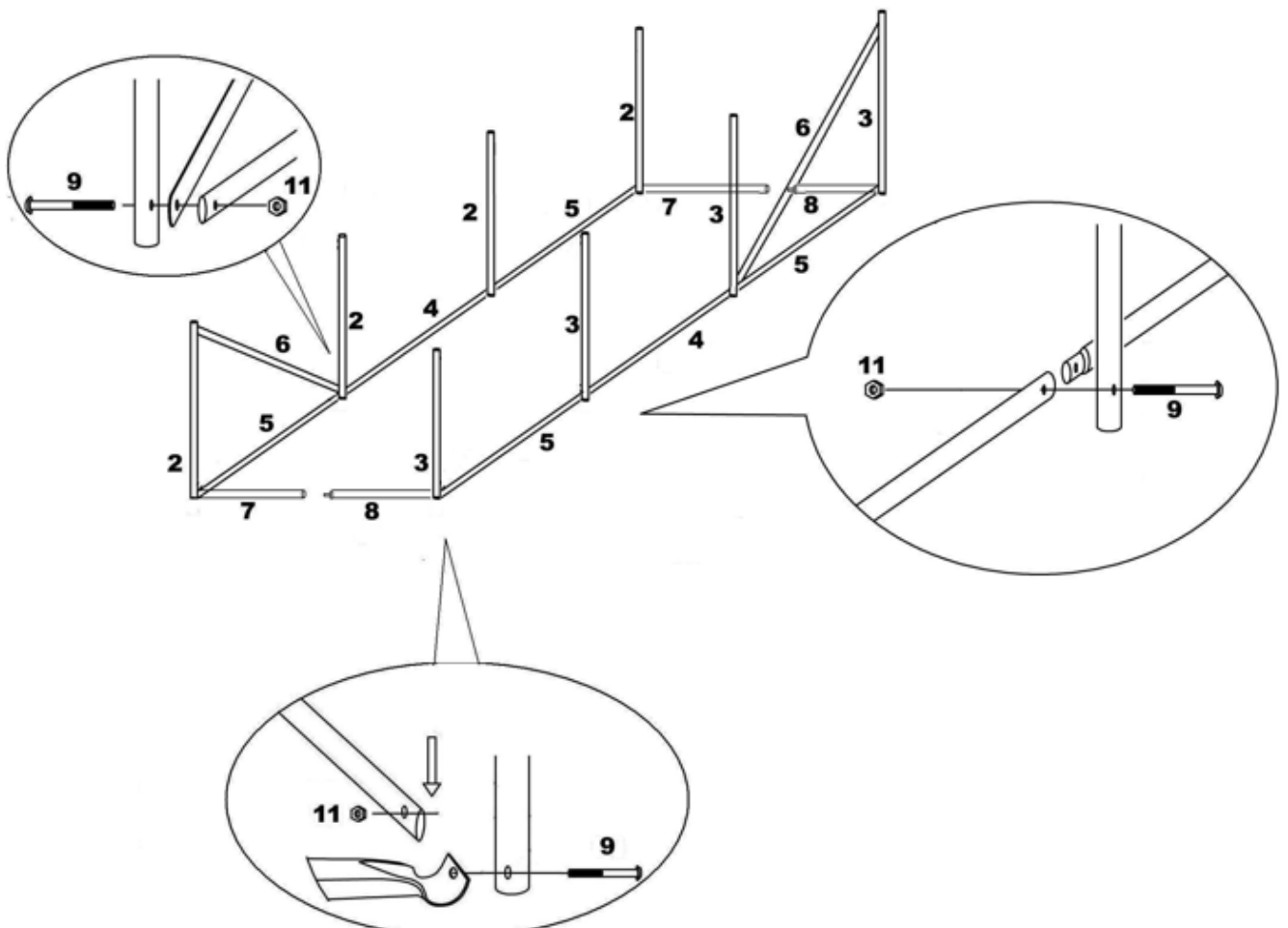

Dra inte åt alla bultar och muttrar ordentligt förrän hela monteringen är klar.

## Steg 2

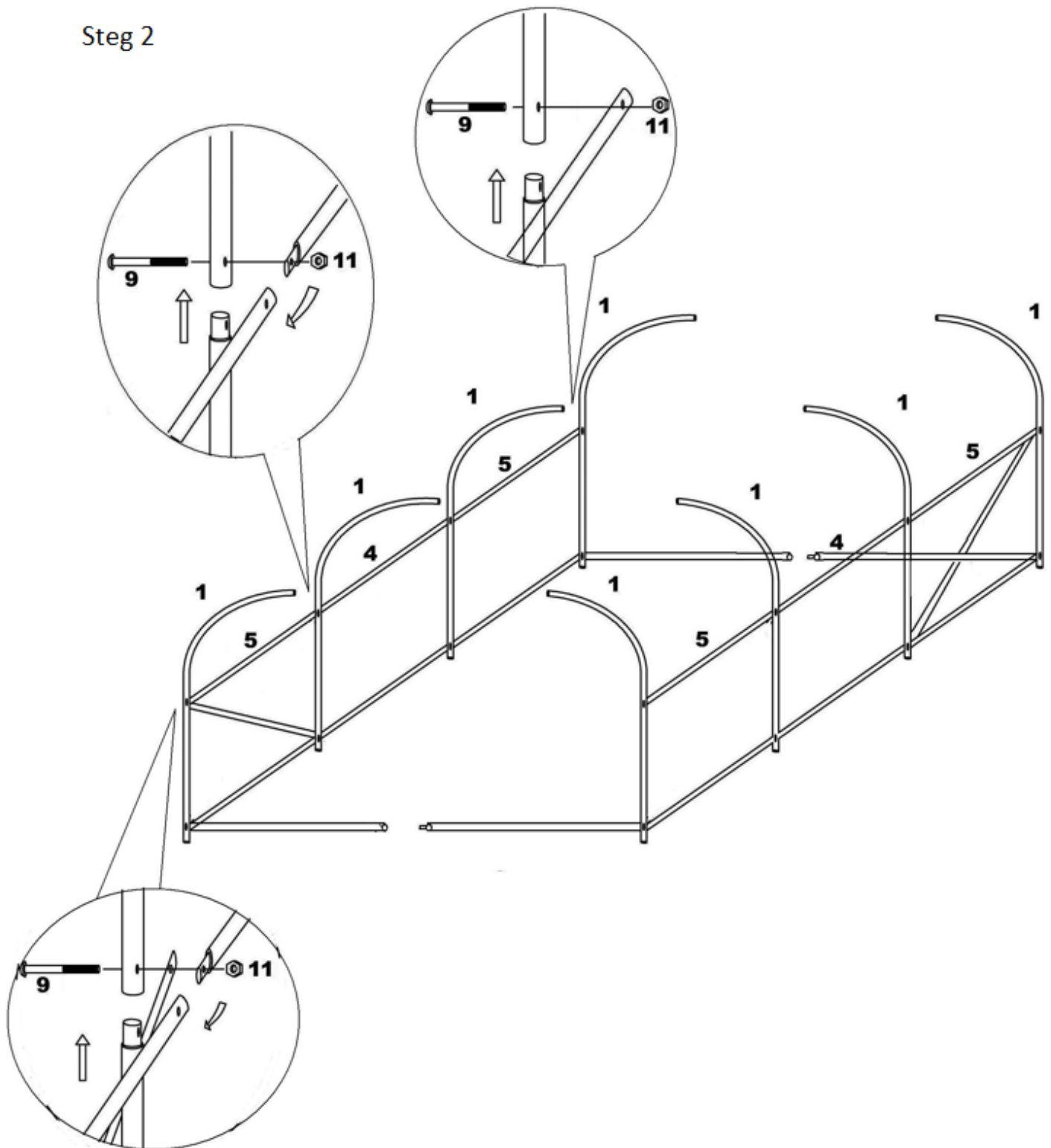

Dra inte åt alla bultar och muttrar ordentligt förrän hela monteringen är klar.

## Steg 3

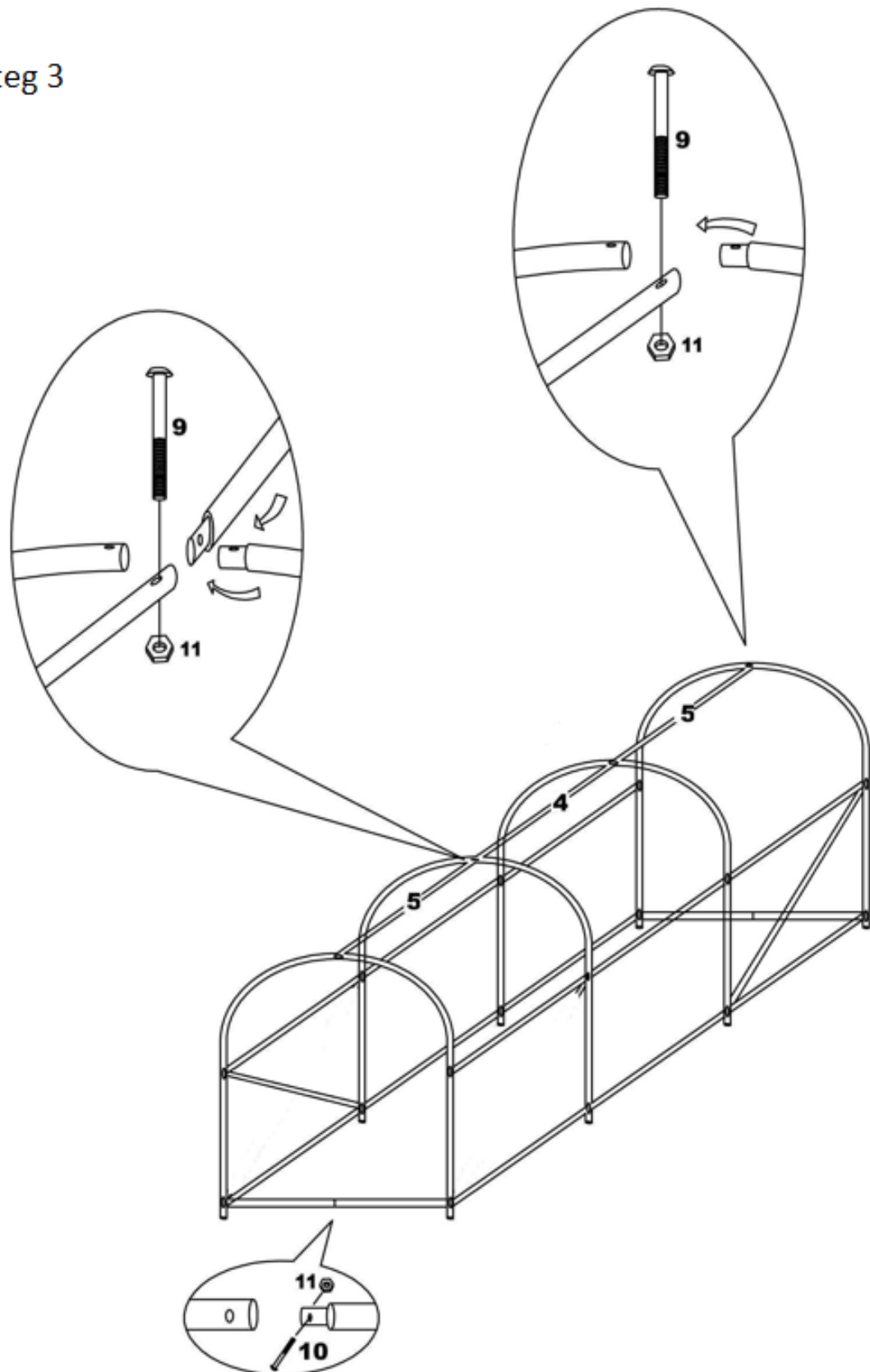

Dra inte åt alla bultar och muttrar ordentligt förrän hela monteringen är klar.

Steg 4

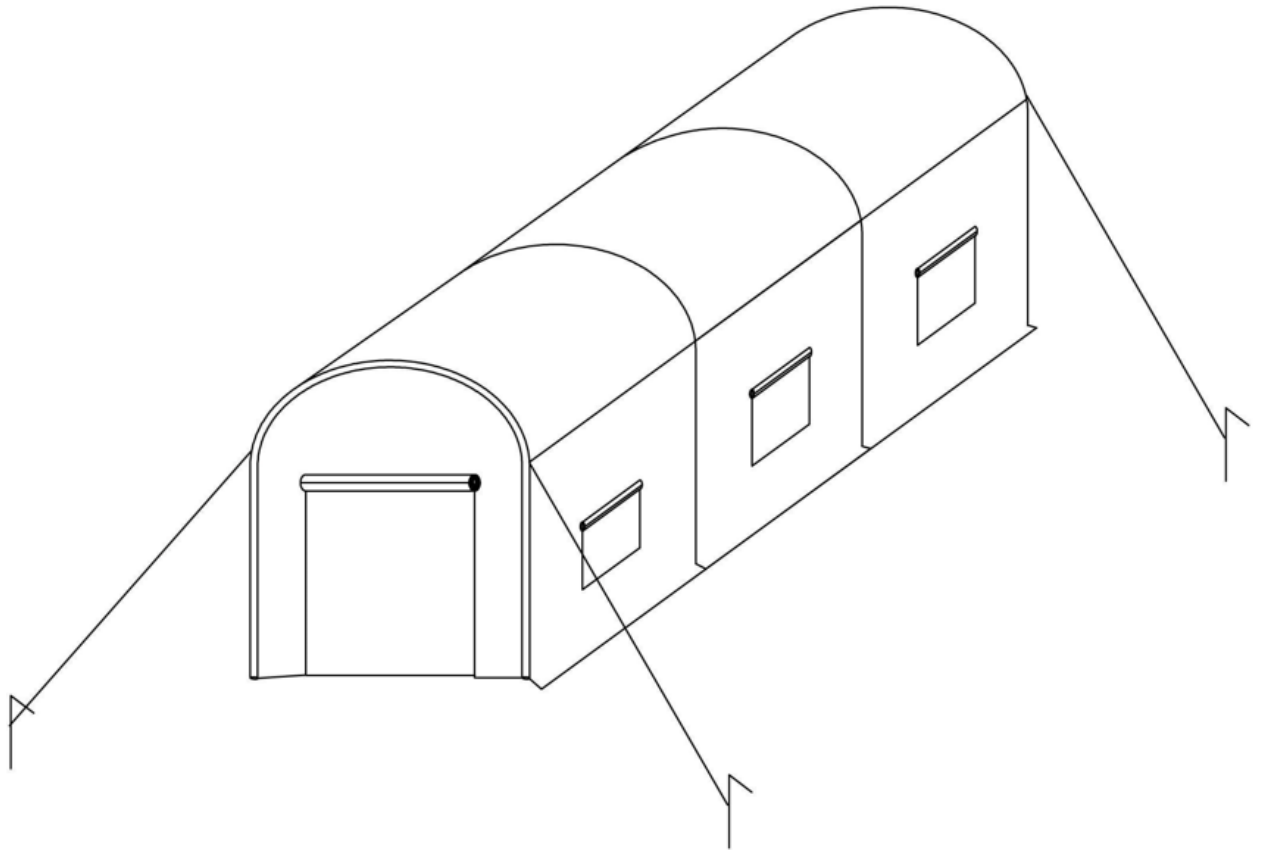

## Konsumentkontakt

Arc E-commerce AB

Box 3124

13603 Haninge

Sverige