

DE	Gebrauchsanleitung / Montageanleitung	2
FR	Mode d'emploi / Instructions de montage	2
EN	Instructions for use / Assembly instructions	3
IT	Istruzioni per l'uso / Istruzioni per Installazione	3
ES	Modo de empleo / Instrucciones de montaje	4
NL	Gebruiksaanwijzing / Handleiding	4
DK	Brugsanvisning / Monteringsvejledning	5
PT	Instruções para uso / Manual de Instalação	5
PL	Instrukcja obsługi / Instrukcja montażu	6
CS	Návod k použití / Montážní návod	6
SK	Návod na použitie / Montážny návod	7
ZH	用户手册 / 组装说明	7
RU	Руководство пользователя / Инструкция по монтажу	8
HU	Használati útmutató / Szerelési útmutató	8
FI	Käyttöohje / Asennusohje	9
SV	Bruksanvisning / Monteringsanvisning	9
LT	Vartotojo instrukcija / Montavimo instrukcijos	10
HR	Upute za uporabu / Uputstva za instalaciju	10
TR	Kullanım kılavuzu / Montaj kılavuzu	11
RO	Manual de utilizare / Instrucțiuni de montare	11
EL	Οδηγίες χρήσης / Οδηγία συναρμολόγησης	12
SL	Navodilo za uporabo / Navodila za montažo	12
ET	Kasutusjuhend / Paigaldusjuhend	13
LV	Lietošanas pamācība / Montāžas instrukcija	13
SR	Uputstvo za upotrebu / Uputstvo za montažu	14
NO	Bruksanvisning / Montasjeveiledning	14
BG	Инструкция за употреба / Ръководство за монтаж	15
SQ	Udhëzuesi i përdorimit / Udhëzime rreth montimit	15
AR	دليل الاستخدام / تعليمات التجميع	16

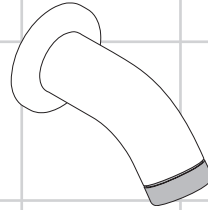

27438XXX

27438XX1

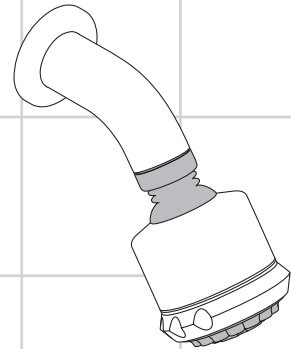

Clubmaster

26606000 / 27475000

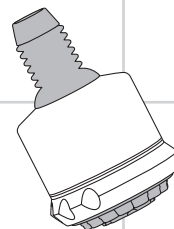





Clubmaster

28496XXX



Sicherheitshinweise

-  Bei der Montage müssen zur Vermeidung von Quetsch- und Schnittverletzungen Handschuhe getragen werden.
-  Der Kontakt der Brausestrahlen mit empfindlichen Körperstellen (z. B. Augen) muss vermieden werden. Es muss ein ausreichender Abstand zwischen Brause und Körper eingehalten werden.
-  Die Brause darf nur zur Bade-, Hygiene- und Körperreinigungszwecke eingesetzt werden.
-  Der Kopfbrausearm ist nur für das Halten der Kopfbrause ausgelegt, er darf nicht mit weiteren Gegenständen belastet werden!

Montagehinweise

Die der Brause beige packte Siebdichtung muss eingebaut werden, um Schmutzeinspülungen aus dem Leitungsnetz zu vermeiden. Schmutzeinspülungen können die Funktion beeinträchtigen und/oder zu Beschädigungen an Funktionsteilen der Brause führen, für hieraus ergebende Schäden haftet Hansgrohe nicht.

Technische Daten

Betriebsdruck:	max. 0,6 MPa
Empfohlener Betriebsdruck: (1 MPa = 10 bar = 147 PSI)	0,2 - 0,4 MPa
Heißwassertemperatur:	max. 60°C
Thermische Desinfektion:	max. 70°C / 4 min

Das Produkt ist ausschließlich für Trinkwasser konzipiert!

Symbolerklärung



Maße (siehe Seite 18)



Durchflussdiagramm
(siehe Seite 18)







Serviceteile (siehe Seite 20)



Reinigung (siehe Seite 19) und beiliegende Broschüre

Consignes de sécurité

-  Lors du montage, porter des gants de protection pour éviter toute blessure par écrasement ou coupure.
-  Éviter le contact du jet de la douchette avec les parties sensibles du corps (telles par ex. que les yeux). Veiller à respecter un écart suffisant entre la douchette et le corps
-  La douchette ne doit servir qu'à se doucher, à se nettoyer et à pratiquer une hygiène corporelle.
-  Le bras de la douchette n'est conçu que pour tenir la douchette et ne doit pas servir à la suspension d'autres objets !

Instructions pour le montage

Le joint à filtre fourni avec la pomme de douche à main doit être installé afin de retenir des impuretés du système de conduites. Ceux-ci pourraient influencer le fonctionnement de ce produit et même endommager des pièces mobiles. Des réclamations à la suite de l'usage de la pomme de douche sans joint-tamis de hansgrohe ne peuvent pas faire partie de notre garantie.

Informations techniques

Pression de service autorisée:	max. 0,6 MPa
Pression de service conseillée: (1 MPa = 10 bar = 147 PSI)	0,2 - 0,4 MPa
Température d'eau chaude:	max. 60°C
Désinfection thermique:	max. 70°C / 4 min

Le produit est exclusivement conçu pour de l'eau potable!

Description du symbole



Dimensions (voir page 18)



Diagramme du débit
(voir page 18)



Pièces détachées (voir page 20)







Nettoyage (voir page 19) et brochure ci-jointe





Safety Notes

-  Gloves should be worn during installation to prevent crushing and cutting injuries.
-  Do not allow the streams of the shower touch sensitive body parts (such as your eyes). An adequate distance must be kept between the shower and you.
-  The shower may only be used for bathing, hygiene and body cleansing purposes.
-  The arm of the shower head is intended only to hold the shower head. Do not load it down with other objects!

Installation Instructions

The mesh washer must be insert to protect the overhead shower against incoming dirt by pipework. Incoming dirt leads to defects or/and can damage parts of the shower; such caused faults voids all liability and guarantee claims.

Technical Data

Operating pressure:	max. 0,6 MPa
Recommended operating pressure:	0,2 - 0,4 MPa
(1 MPa = 10 bar = 147 PSI)	
Hot water temperature:	max. 60 °C
Thermal disinfection:	max. 70 °C / 4 min

The product is exclusively designed for drinking water!

Symbol description



Dimensions (see page 18)



Flow diagram
(see page 18)







Spare parts (see page 20)



Cleaning (see page 19) and enclosed brochure

Indicazioni sulla sicurezza

-  Durante il montaggio, per evitare ferite da schiacciamento e da taglio bisogna indossare guanti protettivi.
-  Bisogna evitare il contatto fra il getto della doccia e parti del corpo delicate (ad es. gli occhi). Fra il soffione ed il corpo va mantenuta una distanza sufficiente.
-  La doccia deve essere impiegata solo per il bagno e utilizzo igienico e pulizia del corpo.
-  Il braccio del soffione della doccia è progettato per sostenere solo quest'ultimo, non va sovraccaricato con altri oggetti!

Istruzioni per il montaggio

Per proteggere la soffione doccia da eventuali impurità provenienti dalle tubazioni dell'acqua, deve essere inserito il filtro nell'impugnatura della doccia stessa. Tali impurità possono infatti causare difetti e/o danneggiare parti della doccia; in questo caso la Hansgrohe non risponde dei danni.

Dati tecnici

Pressione d'uso:	max. 0,6 MPa
Pressione d'uso consigliata:	0,2 - 0,4 MPa
(1 MPa = 10 bar = 147 PSI)	
Temperatura dell'acqua calda:	max. 60 °C
Disinfezione termica:	max. 70 °C / 4 min

Il prodotto è concepito esclusivamente per acqua potabile!

Descrizione simbolo



Ingombri (vedi pagg. 18)



Diagramma flusso
(vedi pagg. 18)



Parti di ricambio (vedi pagg. 20)



Pulitura (vedi pagg. 19) e brochure allegata





Assembly
see page 17



Montaggio
vedi pagg. 17



Indicaciones de seguridad

-  Durante el montaje deben utilizarse guantes para evitar heridas por aplastamiento o corte.
-  Debe evitarse el contacto del chorro del pulverizador con partes sensibles del cuerpo (por ej. ojos). Debe mantenerse una distancia suficiente entre pulverizador y cuerpo.
-  La roseta de ducha solo debe utilizarse para fines de baño, higiene y limpieza corporal.
-  El brazo del pulverizador de ducha solo está previsto para soportar el pulverizador de ducha. No debe cargarse con otros objetos!

Indicaciones para el montaje

La junta de filtración que se suministra con la ducha mural evita que las partículas de suciedad procedentes de las tuberías lleguen a la ducha mural. Debe colocarse entre el flexo y la ducha mural. Infiltraciones de suciedad deterioran el funcionamiento de la ducha mural y pueden causar daños en el interior de la misma que no están cubiertas por la garantía de Hansgrohe.

Datos técnicos

Presión en servicio:	max. 0,6 MPa
Presión recomendada en servicio:	0,2 - 0,4 MPa
(1 MPa = 10 bar = 147 PSI)	
Temperatura del agua caliente:	max. 60°C
Desinfección térmica:	max. 70°C / 4 min

El producto ha sido concebido exclusivamente para agua potable.

Descripción de símbolos



Dimensiones (ver página 18)



Diagrama de circulación
(ver página 18)







Repuestos (ver página 20)



Limpiar (ver página 19) y folleto anexo

Veiligheidsinstructies

-  Bij de montage moeten ter voorkoming van knel- en snijwonden handschoenen worden gedragen.
-  Het contact van de douchestraal met gevoelige lichaamsdelen (bijv. ogen) moet worden voorkomen. Er moet voldoende afstand tussen douche en lichaam aangehouden worden.
-  De douche uitsluitend toepassen in badkamers ten behoeve van lichaamsreiniging.
-  De arm van de hoofddouche is uitsluitend voor het vasthouden van de hoofddouche bedoeld en mag niet met verdere voorwerpen worden belast!

Montage-instructies

Het bij de hoofddouche verpakte zeefje moet worden ingebouwd om vuil uit de waterleiding te weren. Vuil uit de leidingen kan de werking van de hoofddouche negatief beïnvloeden en/of de hoofddouche beschadigen. Voor deze schade is Hansgrohe niet verantwoordelijk.

Technische gegevens

Werkdruk: max.	max. 0,6 MPa
Aanbevolen werkdruk:	0,2 - 0,4 MPa
(1 MPa = 10 bar = 147 PSI)	
Temperatuur warm water:	max. 60°C
Thermische desinfectie:	max. 70°C / 4 min

Het product is uitsluitend ontworpen voor drinkwater!

Symboolbeschrijving



Maten (zie blz. 18)



Doorstroomdiagram
(zie blz. 18)



Service onderdelen (zie blz. 20)







Reinigen (zie blz. 19) en bijgevoegde brochure





Sikkerhedsanvisninger

-  Ved monteringen skal der bruges handsker for at undgå kvæstelser og snitsår.
-  Bruserstrålekontakt med sensitive områder (f.eks. øjne) skal undgås. Der skal være en tilstrækkelig afstand mellem bruseren og kroppen.
-  Bruseren må kun bruges til at bruse, til hygiejne og rengøring af kroppen.
-  Stangen til hovedbruseren er kun beregnet til at holde hovedbruseren. Den må ikke belastes med andre genstande!

Monteringsanvisninger

Den vedlagte smudsfangssi skal indsættes i bruseren for at undgå snavs fra rørsystemet. Indskyllet snavs kan have indflydelse på bruserens funktion og/eller føre til beskadigelser på håndbruserens komponenter.

Tekniske data

Driftstryk:	max. 0,6 MPa
Anbefalet driftstryk: (1 MPa = 10 bar = 147 PSI)	0,2 - 0,4 MPa
Varmtvandstemperatur:	max. 60°C
Termisk desinfektion:	max. 70°C / 4 min

Produktet er udelukkende beregnet til drikkevand!

Symbolbeskrivelse



Målene (se s. 18)



Reserve dele (se s. 20)







Doorstroombiagram
(se s. 18)



Rengøring (se s. 19) og vedlagt brochure

Avisos de segurança

-  Durante a montagem devem ser utilizadas luvas de protecção, de modo a evitar ferimentos resultantes de entalamentos e de cortes.
-  Deve-se evitar o contacto dos jactos de água com partes do corpo sensíveis (p. ex. olhos). É necessário manter uma distância suficiente entre o chuveiro e o corpo.
-  O chuveiro só pode ser utilizado para fins de higiene pessoal.
-  O braço do chuveiro foi concebido apenas para servir de apoio à cabeça do chuveiro, pelo que não pode ser sujeito a cargas de objectos adicionais!

Avisos de montagem

O filtro de rede deve ser colocado para proteger o chuveiro de areias e resíduos provenientes da tubagem. Resíduos e areias podem danificar componentes, ou provocar mau funcionamento do chuveiro; as avarias assim provocadas anulam a nossa responsabilidade e anulam a nossa garantia.

Dados Técnicos

Pressão de funcionamento:	max. 0,6 MPa
Pressão de func. recomendada: (1 MPa = 10 bar = 147 PSI)	0,2 - 0,4 MPa
Temperatura da água quente:	max. 60°C
Desinfecção térmica:	max. 70°C / 4 min

Este produto foi única e exclusivamente concebido para água potável!

Descrição do símbolo



Medidas (ver página 18)



Fluxograma
(ver página 18)



Peças de substituição
(ver página 20)







Limpeza (ver página 19) e brochura em anexo





Wskazówki bezpieczeństwa

-  Aby uniknąć zranień, takich jak zgniecenia czy przecięcia, podczas montażu należy nosić rękawice.
-  Należy unikać kontaktu strumienia wypywającego z głowicy z wrażliwymi częściami ciała (np. oczami). Należy zachowywać odpowiednią odległość pomiędzy głowicą a ciałem.
-  Prysznic może być używany tylko do kąpieli, higieny i czyszczenia ciała.
-  Ramię prysznica jest przystosowane do trzymania głowicy prysznica i nie może być obciążane innymi przedmiotami!

Wskazówki montażowe

Znajdujące się przy prysznicy sitko musi zostać zainstalowane, aby zatrzymać zanieczyszczenia z instalacji. Przedostające się zanieczyszczenia mogą mieć ujemny wpływ na działanie i/lub prowadzić do usterek w działaniu elementów prysznica. Za powstałe z tego tytułu szkody firma Hansgrohe nie ponosi odpowiedzialności.

Dane techniczne

Ciśnienie robocze:	maks. 0,6 MPa
Zalecane ciśnienie robocze:	0,2 - 0,4 MPa
(1 MPa = 10 bary = 147 PSI)	
Temperatura wody gorącej:	maks. 60°C
Dezynfekcja termiczna:	maks. 70°C / 4 min

Produkt stworzono wyłącznie do wody pitnej!

Opis symbolu



Wymiary (patrz strona 18)



Schemat przepływu
(patrz strona 18)







Części serwisowe
(patrz strona 20)



Czyszczenie (patrz strona 19) i dołączona broszura

Bezpečnostní pokyny

-  Pro zabránění řezným zraněním a pohmožděním je nutné při montáži nosit rukavice.
-  Je nutné zabránit kontaktu vodních paprsků sprchy s měkkými částmi těla (např. očima). Je nutné dodržovat dostatečný odstup mezi sprchou a tělem.
-  Sprcha smí být používána pouze za účelem koupání a tělesné hygieny.
-  Držák sprchové hlavice je dimenzován pouze pro držení sprchové hlavice a nesmí se zatěžovat dalšími předměty!

Pokyny k montáži

Do přívodu musí být zabudováno se sprchou dodávané sítko, aby zachycovalo nečistoty vyplavené z vodovodní sítě. Vyplavené nečistoty mohou ovlivnit funkci sprchy a nebo mohou vést i k jejímu poškození. Na takto vzniklé škody se nevztahuje záruka firmy Hansgrohe.

Technické údaje

Provozní tlak:	max. 0,6 MPa
Doporučený provozní tlak:	0,2 - 0,4 MPa
(1 MPa = 10 bar = 147 PSI)	
Teplota horké vody:	max. 60°C
Teplná desinfekce:	max. 70°C / 4 min

Výrobky Hansgrohe jsou vhodné pro přímý kontakt s pitnou vodou.

Popis symbolů



Rozmíry (viz strana 18)



Diagram průtoku
(viz strana 18)



Servisní díly (viz strana 20)



Čištění (viz strana 19) a příložená brožura





! Bezpečnostné pokyny

- △ Pri montáži musíte nosiť rukavice, aby ste predišli pomliaždeninám a rezným poraneniam.
- △ Vyhýbajte sa kontaktu vodného lúča sprchy s citlivými miestami tela (napr. oči). Dodržiavajte dostatočnú vzdialenosť medzi sprchou a telom.
- △ Sprcha sa smie používať len na účely kúpania a telesnej hygieny.
- △ Rameno držiaka hlavice sprchy je určené len na uchytienie hlavice sprchy a nesmie sa zaťažovať inými predmetmi!

Pokyny pre montáž

Do prívodu musí byť zabudované so sprchou dodávané sítko, aby zachytilo nečistoty vyplavené z vodovodnej siete. Vyplavené nečistoty môžu ovplyvniť funkciu sprchy, alebo spôsobiť jej poškodenie. Na takto vzniknuté škody sa nevzťahuje záruka firmy Hansgrohe.

Technické údaje

Prevádzkový tlak:	max. 0,6 MPa
Doporučený prevádzkový tlak: (1 MPa = 10 bar = 147 PSI)	0,2 - 0,4 MPa
Teplota teplej vody:	max. 60°C
Termická dezinfekcia:	max. 70°C / 4 min

Výrobok je koncipovaný výhradne pre pitnú vodu!

Popis symbolov



Rozmery (viď strana 18)



Diagram prietoku
(viď strana 18)



Servisné diely (viď strana 20)



Čistenie (viď strana 19) a priložená brožúra

! 安全技巧

- △ 装配时为避免挤压和切割受伤，必须戴上手套。
- △ 必须避免让身体敏感部位（如眼睛）接触到莲蓬头喷水。必须保持莲蓬头与人头之间有足够的距离。
- △ 该莲蓬头仅允许作淋浴、卫生保健和身体清洁目的使用。
- △ 头顶莲蓬头夹持杆只为夹持头顶莲蓬头而设计，不得让其承载其它物品！

安装提示

必须装上花洒所自带的滤网密封垫，以过滤管道里的杂质污物。杂质污物会影响花洒的功能和/或损坏花洒的功能部件，由此而产生的产品损坏不属于汉斯格雅的保修范围。

技术参数

工作压力:	最大 0,6 MPa
推荐工作压力:	0,2 - 0,4 MPa
(1 MPa = 10 bar = 147 PSI)	
热水温度:	最大 60°C
热力消毒:	最大 70°C / 4 分钟

该产品专为饮用水设计！

符号说明



大小 (参见第 18 页)



流量示意图
(参见第 18 页)



备用零件 (参见第 20 页)



清洗 (参见第 19 页) 并附有小手册





Montáž
viď strana 17



安装
参见第 17 页



Указания по технике безопасности

-  Во время монтажа следует надеть перчатки во избежание прищемления и порезов.
-  Не допускайте попадания струи воды из разбрызгивателя на чувствительные части тела (например, на глаза). Разбрызгиватель следует устанавливать на достаточном расстоянии от тела.
-  Источник разбрызгивания разрешается использовать только в гигиенических целях для принятия ванны и личной гигиены.
-  Кронштейн верхнего душа предназначен только для подсоединения верхнего душа. Запрещается подвешивать на него другие предметы!

Указания по монтажу

Для предотвращения попадания частиц грязи из водопроводной сети необходимо установить фильтр, прилагаемый к ручному душу. Частицы грязи могут нарушить отдельные функции и/или привести к повреждению функциональных деталей ручного душа, Hansgrohe не несет ответственность за повреждения вследствие отсутствия фильтра.

Технические данные

Рабочее давление: не более. 0,6 МПа
 Рекомендуемое рабочее давление: 0,2 - 0,4 МПа
 (1 МПа = 10 bar = 147 PSI)
 Температура горячей воды: не более. 60°C
 Термическая дезинфекция: не более. 70°C / 4 мин

Изделие предназначено исключительно для питьевой воды!

Описание символов



Размеры (см. стр. 18)



Схема потока
(см. стр. 18)







Комплект (см. стр. 20)



Очистка (см. стр. 19) и прилагаемая брошюра

Biztonsági utasítások

-  A szerelésnél a zúzódások és vágási sérülések elkerülése érdekében kesztyűt kell viselni.
-  Kerülni kell a zuhanyugár érintkezését érzékeny testrészekkel (pl. szemek). Be kell tartani a megfelelő távolságot a zuhanyfej és a test között.
-  A zuhanyt csak fürdő- higiéniai- és tisztítási célra szabad használni.
-  A zuhanyfej karja csak a zuhanyfej tartására alkalmas, és nem szabad más tárgyakkal megterhelni!

Szerelési utasítások

A kézi zuhanyhoz csomagolt szűrőtmitést be kell szerelni a vízhálózatból származó szennyeződések kiküszöbölésére. A beáramló szennyeződések akadályozhatják és / vagy teljesen tönkre is tehetik a zuhany funkcióit. Az ezekből adódó károkért a Hansgrohe nem felel.

Műszaki adatok

Üzemi nyomás: max. 0,6 MPa
 Ajánlott üzemi nyomás: 0,2 - 0,4 MPa
 (1 MPa = 10 bar = 147 PSI)
 Forróvíz hőmérséklet: max. 60°C
 Termikus fertőtlenítés: max. 70°C / 4 perc

A terméket kizárólag ivóvízhez tervezték!

Szimbólumok leírása



Méretet (lásd a 18. oldalon)



Átfolyási diagramm
(lásd a 18. oldalon)



Tartozékok (lásd a 20. oldalon)







Tisztítás (lásd a 19. oldalon) és mellékelt brossúrával





Turvallisuusohjeet

-  Asennuksessa on käytettävä käsiineitä puristumien ja viiltojen aiheuttamien tapaturmien estämiseksi.
-  Suihkuveden kontaktia herkkien ruumiinosien (esim. silmien) kanssa on vältettävä. Suihkun ja vartalon välissä on oltava riittävä väli.
-  Suihkua saa käyttää vain kylpy-, hygienia ja kehonpuhdistustarkoituksiin.
-  Pääsuihkun varsi on tarkoitettu vain kannattamaan pääsuihkua. Sitä ei saa kuormittaa muilla esineillä!

Asennusohjeet





Käsisuihkun mukana toimitettu sihtitiiviste on asennettava paikalleen, jotta lian huuhtoutuminen vesijohtoverkostosta käsisuihkuun estyy. Huuhtoutuvat likahiukaset voivat häiritä suihkun toimintaa tai vahingoittaa toimintaosia, Hansgrohe ei vastaa tästä aiheutuneista vahingoista.

Tekniset tiedot

Käyttöpaine:	maks. 0,6 MPa
Suosittelut käyttöpaine:	0,2 - 0,4 MPa
(1 MPa = 10 bar = 147 PSI)	
Kuuman veden lämpötila:	maks. 60°C
Lämpödesinfektio:	maks. 70°C / 4 min

Tuote on suunniteltu käytettäväksi ainoastaan juomaveden kanssa!

Säkerhetsanvisningar

-  Handskar ska bäras under monteringsarbetet så att man kan undvika kläm- och skärskadorgen werden.
-  Undvik att rikta duschstrålarna mot känsliga kroppsdelar (t. ex. ögonen. Det måste finnas ett tillräckligt stort avstånd mellan duschen och kroppen.
-  Duschen får bar användas till dusch-, bad- och personlig hygien.
-  Armen som håller huvudduschen är bara konstruerad för detta; den får inte belastas med andra föremål!

Monteringsanvisningar

Silpackningen som följer med duschen måste monteras för att undvika att smuts från ledningsnätet tränger in. Smuts som spolats in kan påverka funktionerna och/eller leda till skador på funktionsdelar i duschen. Hansgrohe fransäger sig allt ansvar för skador som kan härledas till detta.

Tekniska data

Driftstryck:	max. 0,6 MPa
Rek. driftstryck:	0,2 - 0,4 MPa
(1 MPa = 10 bar = 147 PSI)	
Varmvattentemperatur:	max. 60°C
Termisk desinfektion:	max. 70°C / 4 min

Produkten är enbart avsedd för dricksvatten!

Merkin kuvaus



Mitat (katso sivu 18)



Virtausdiagrammi
(katso sivu 18)



Varaosat (katso sivu 20)



Puhdistus (katso sivu 19) ja oheinen esite

Symbolföklaring



Måtten (se sidan 18)



Flödesschema
(se sidan 18)



Reservdelar (se sidan 20)







Rengöring (se sidan 19) och medföljande broschyr





Saugumo technikos nurodymai

-  Apsaugai nuo užspaudimo ir įsijpavimo montavimo metu mūvėkite pirštines.
-  Būtina vengti dušo vandens srovės kontakto su jautriomis kūno vietomis (pvz., akimis). Todėl būtina laikytis tinkamu atstumu nuo dušo.
-  Dušo galva naudojama tik maudymosi, higieniniais ir kūno švarinimo tikslais.
-  Dušo laikiklis skirtas tik dušo galvutei laikyti, todėl neturi būti apkraunamas kitokiais daiktais!

Montavimo instrukcija

Tinklelis, kuris yra rankų dušas pakuotėje, privalo būti įstatytas, kad būtų apsaugota nuo išorės nešvarumų. Nešvarumai gali pakenkti rankų dušas funkcionalumui ir (arba) sugadinti rankų dušas funkcines dalis. Tokiu atveju „Hansgrohe“ atsakomybės neprisiima.

Techniniai duomenys

Darbinis slėgis: ne daugiau kaip 0,6 MPa
 Rekomenduojamas slėgis: 0,2 - 0,4 MPa
 (1 MPa = 10 barų = 147 PSI)
 Karšto vandens temperatūra: ne daugiau kaip 60°C
 Terminis dezinfekavimas: ne daugiau kaip 70°C / 4 min

Produktas skirtas tik geriamajam vandeniui!

Simbolio aprašymas



Išmatavimai (žr. psl. 18)



Pralaidumo diagrama
(žr. psl. 18)







Atsarginės dalys (žr. psl. 20)



Valymas (žr. psl. 19) ir pridėama brošiūra

Sigurnosne upute

-  Prilikom montaže se radi sprječavanja prignječenja i posjekotina moraju nositi rukavice.
-  Mora se izbjegavati kontakt mlaza iz tuša s osjetljivim dijelovima tijela (npr. očima). Tijelo korisnika mora biti dovoljno udaljeno od tuša.
-  Tuš se smije primjenjivati samo za kupanje, tuširanje i osobnu higijenu.
-  Nosač tuša iznad glave je dimenzioniran samo za držanje danog tuša i ne smije se opterećivati drugim predmetima!

Upute za montažu

Filter potrebno je ugraditi kako bi se regulirao protok vode i smanjio dotok prljavštine. Za eventualna oštećenja uzrokovana prljavštinom proizvođač Hansgrohe nije odgovoran.

Tehnički podaci

Najveći dopušteni tlak: tlak 0,6 MPa
 Preporučeni tlak: 0,2 - 0,4 MPa
 (1 MPa = 10 bar = 147 PSI)
 Temperatura vruće vode: tlak 60°C
 Termička dezinfekcija: tlak 70°C / 4 min

Proizvod je koncipiran isključivo za pitku vodu!

Opis simbola



Mjere (pogledaj stranicu 18)



Dijagram protoka
(pogledaj stranicu 18)



Rezervni djelovi (pogledaj stranicu 20)



Čišćenje (pogledaj stranicu 19) i priložena brošura





! Güvenlik uyarıları

- ! Montaj esnasında ezilme ve kesilme gibi yaralanmaları önlemek için eldiven kullanılmalıdır.
- ! Püskürtme başlıklarının hassas organlara teması (örn. gözler) önlenmelidir. Püskürtücü ile beden arasında yeterli mesafe bırakılmalıdır.
- ! Su püskürtücü yalnızca banyo, hijyen ve yıkanma amaçları için kullanılabilir.
- ! Başlıklı püskürtücü kolu yalnızca başlıklı püskürtücünün tutulması için tasarlanmıştır, başka nesnelere üzerine yük bindirilmemelidir!

Montaj açıklamaları

El duşu kafasına eklenmiş olan süzgeç contası, boru şebekesinden sızan kirlerin önüne geçmek için, yerine monte edilmelidir. İçeri sızan bu kirler duşun fonksiyonunu sekteleyebilir ve/veya duşun fonksiyon parçaları üzerinde hasarlara sebep olabilir, bu yüzden meydana gelen hasarlardan Hansgrohe sorumlu tutulamaz.

Teknik bilgiler

İşletme basıncı:	azami 0,6 MPa
Tavsiye edilen işletme basıncı:	0,2 - 0,4 MPa
(1 MPa = 10 bar = 147 PSI)	
Sıcak su sıcaklığı:	azami 60 °C
Termik dezenfeksiyon:	azami 70 °C / 4 dak

Ürün sadece şebeke suyu için tasarlanmıştır!

! Instrucțiuni de siguranță

- ! La montare utilizați mănuși pentru evitarea contuziunilor și tăierii mâinilor.
- ! Evitați contactul jetului de apă cu părțile de corp sensibile (de ex. ochii). Țineți dușul la o distanță corespunzătoare de corp.
- ! Dușul poate fi utilizat doar în scopuri de spălare, igienizare și de întreținere a igienei corporale.
- ! Brațul parei de duș este destinat doar pentru a susține para, acesta nu poate fi prevăzut cu alte obiecte.

Instrucțiuni de montare

Montați garnitura de filtru livrată împreună cu capătul de duș de mână pentru evitarea pătrunderii impurităților din rețeaua de alimentare. Impuritățile pătrunse pot influența funcționarea aparatului și/sau provoca deteriorarea capătului de duș. Garanția nu acoperă aceste daune.

Date tehnice

Presiune de funcționare:	max. 0,6 MPa
Presiune de funcționare recomandată:	0,2 - 0,4 MPa
(1 MPa = 10 bar = 147 PSI)	
Temperatura apei calde:	max. 60 °C
Dezinfecție termică:	max. 70 °C / 4 min

Produsul este destinat exclusiv pentru apă potabilă.

Simge açıklaması



Ölçüleri (Bakınız sayfa 18)



Akış diyagramı
(Bakınız sayfa 18)



Yedek Parçalar (Bakınız sayfa 20)



Temizleme (Bakınız sayfa 19) ve birlikte verilen broşür

Descrierea simbolurilor



Dimensiuni (vezi pag. 18)



Diagrama de debit
(vezi pag. 18)



Piese de schimb (vezi pag. 20)



Curățare (vezi pag. 19) și broșura alăturată

Montajı
Bakınız sayfa 17



Montare
vezi pag. 17

**⚠ Υποδειξεις ασφαλείας**

- ⚠ Για να αποφύγετε τραυματισμούς κατά τη συναρμολόγηση πρέπει να φοράτε γάντια.
- ⚠ Η επαφή δέσμης νερού του ντους με ευαίσθητες περιοχές του σώματος (π.χ. μάτια) πρέπει να αποφεύγεται. Διατηρείτε επαρκή απόσταση ανάμεσα στο ντους και το σώμα.
- ⚠ Το ντους επιτρέπεται να χρησιμοποιείται μόνο για το μπάνιο, τον καθαρισμό και την υγιεινή του σώματος.
- ⚠ Ο βραχιόνος του ντους κεφαλιού έχει μελετηθεί μόνο για να κρατά το ντους κεφαλιού, δεν επιτρέπεται να φορτίζεται με άλλα αντικείμενα!

Οδηγίες συναρμολόγησης

Πρέπει να εγκατασταθεί το παρέμβυσμα φίλτρου που συνοδεύει τον καταιονιστήρα κατά τέτοιο τρόπο, ώστε να αποφεύγονται ρύποι που προέρχονται από το δίκτυο ύδρευσης. Οι ρύποι από το δίκτυο ύδρευσης μπορούν να επηρεάσουν αρνητικά και/ή να προξενήσουν ζημία στα λειτουργικά τμήματα του καταιονιστήρα (ντους). Τέτοιου είδους ζημιές δεν καλύπτονται από την εγγύηση Hansgrohe.

Τεχνικά Χαρακτηριστικά

Λειτουργία πίεσης:	έως 0,6 MPa
Συνιστώμενη λειτουργία πίεσης:	0,2 - 0,4 MPa
(1 MPa = 10 bar = 147 PSI)	
Θερμοκρασία ζεστού νερού:	έως 60°C
Θερμική απολύμανση:	έως 70°C / 4 min

Το προϊόν έχει σχεδιαστεί αποκλειστικά για πόσιμο νερό!

Περιγραφή συμβόλων**Διαστάσεις** (βλ. σελίδα 18)**Διάγραμμα ροής**
(βλ. σελίδα 18)**Ανταλλακτικά** (βλ. σελίδα 20)**Καθαρισμός** (βλ. σελίδα 19) και
συνημμένο φυλλάδιο**⚠ Varnostna opozorila**

- ⚠ Pri montaži je treba nositi rokavice, da se prepreči poškodbe zaradi zmečkanja ali urezov.
- ⚠ Éviter le contact du jet de la douchette avec les parties sensibles du corps (telles par ex. que les yeux). Veiller à respecter un écart suffisant entre la douchette et le corps
- ⚠ Prha se sme uporabljati le z namenom vzdrževanja higiene oziroma umivanja kopalnice in telesa.
- ⚠ Nosilna roka naglavne prhe je konstruirana le za nošenje prhe in je ne smete obremeniti z drugimi predmeti!

Navodila za montažo

Filter, ki je priložen ročni prhi, je potrebno vgraditi, da prho zaščitimo pred umazanijo iz vodovodne napeljave. Umazanija lahko okvari ali poškoduje dele ročne prhe. Za tako nastalo škodo Hansgrohe ne odgovarja.

Tehnični podatki





Delovni tlak:	maks. 0,6 MPa
Priporočeni delovni tlak:	0,2 - 0,4 MPa
(1 MPa = 10 bar = 147 PSI)	
Temperatura tople vode:	maks. 60°C
Termična dezinfekcija:	maks. 70°C / 4 min

Proizvod je zasnovan izključno za sanitarno vodo!

Opis simbola**Mere** (glejte stran 18)**Diagram pretoka**
(glejte stran 18)**Rezervni deli** (Glejte stran 20.)**Čiščenje** (glejte stran 19) in priložena brošura



Ohutusjuhised

-  Kandke paigaldamisel muljumis- ja löikevigastuste vältimiseks kindaid.
-  Duši veejoad ei tohi kokku puutuda tundlike kehaosadega (nt silmad). Jätke duši ja keha vahele piisav vahe.
-  Dušši tohib kasutada ainult vanniskäimiseks, hügieeniks ja keha pesemiseks.
-  Dušipea hoidik on mõeldud ainult dušipea hoidmiseks ja seda ei tohi muude esemetega koormata!

Paigaldamisjuhised





Kaitsmaks dušši torust tuleva mustuse eest, on vaja paigaldada dušiga kaasasolev mustusesõel. Sissetulev mustus võib funktsioneerimist kahjustada ja/või rikkuda dušši detaile. Sellest tulenevate kahjude eest Hansgrohe ei vastuta.

Tehnilised andmed

Töörõhk	maks. 0,6 MPa
Soovitatav töörõhk:	0,2 - 0,4 MPa
(1 MPa = 10 baari = 147 PSI)	
Kuuma vee temperatuur:	maks. 60°C
Termiline desinfitatsioon:	maks. 70°C / 4 min

Toode on ette nähtud eranditult joogivee jaoks!

Drošības norādes

-  Montāžas laikā, lai izvairītos no saspiedumiem un iegriezumiem, nepieciešams nēsāt cimdus.
-  Nepieciešams izvairīties no dušas strūkļas tieša kontakta ar jutīgām ķermeņa daļām (piem., acīm). Nepieciešams ievērot pietiekošu attālumu starp dušu un ķermeni.
-  Dušu drīkst izmantot vienīgi vannošānās, higiēnas un ķermeņa tīrīšanas nolūkiem.
-  Galvas dušas statīvs paredzēts vienīgi galvas dušas atbalsīšanai, to nedrīkst noslogot ar citiem priekšmetiem!

Norādījumi montāžai

Jāiemontē dušas komplektā esošais filtrs, lai novērstu neīrūmu ieplūšanu no ūdens vada. Ieskalotie neīrūmi var traucēt dušas funkciju un / vai arī izraisīt rokas dušas daļu bojājumus, par kuriem Hansgrohe neenes atbildību.

Tehniskie dati

Darba spiediens:	maks. 0,6 MPa
Ieteicamais darba spiediens:	0,2 - 0,4 MPa
(1 MPa = 10 bar = 147 PSI)	
Karstā ūdens temperatūra:	maks. 60°C
Termiskā dezinfekcija:	maks. 70°C / 4 min

Izstrādājums ir paredzēts tikai dzeramajam ūdenim!

Sūmbolite kirjeldus



Mõõtude (vt lk 18)



Läbivooludiagramm
(vt lk 18)



Varuosad (vt lk 20)



Puhastamine (vt lk 19) ja kaasasolev brošüür

Simbolu nozīme



Izmērus (skat. 18. lpp.)



Caurplūdes diagramma
(skat. 18. lpp.)



Rezerves daļas (skat. 20. lpp.)







Tīrīšana (skat. 19. lpp.) un klāt pievienotais buklets





Sigurnosne napomene

-  Prilikom montaže se radi sprečavanja prignječanja i posekotina moraju nositi rukavice.
-  Mora se izbegavati kontakt mlaza iz tuša sa osetljivim delovima tela (npr. očima). Telo korisnika mora biti na dovoljnom odstojanju od tuša.
-  Tuš sme da se koristi samo za kupanje, tuširanje i ličnu higijenu.
-  Nosač tuša iznad glave je dimenzioniran samo za držanje datog tuša i ne sme se opterećivati drugim predmetima!

Instrukcije za montažu

Obavezno ugradite mrežicu upakovanu s tušem, čime sprečavate ulazak prljavštine iz vodovoda. Prljavština može dovesti do delimičnog ili potpunog oštećenja delova tuša. Za eventualna oštećenja uzrokovana prljavštinom proizvođač Hansgrohe nije odgovoran.

Tehnički podaci

Radni pritisak:	maks. 0,6 MPa
Preporučeni radni pritisak:	0,2 - 0,4 MPa
(1 MPa = 10 bar = 147 PSI)	
Temperatura vruće vode:	maks. 60°C
Termička dezinfekcija:	maks. 70°C / 4 min

Proizvod je koncipiran isključivo za pijaću vodu!

Opis simbola



Mere (vidi stranu 18)



Dijagram protoka
(vidi stranu 18)







Rezervni delovi (vidi stranu 20)



Čišćenje (vidi stranu 19) i
priložena brošura

Ispitni znak (vidi stranu _1i)

Sikkerhetshenvisninger

-  Bruk hansker under montasjonen for å unngå klem- og kuttskader.
-  Dusjstrålen skal ikke komme i kontakt med ømfintlige kroppsdeler (f.eks. øynene). Overhold en tilstrekkelig avstand mellom dusjen og kroppen.
-  Dusjen skal kun brukes for bading, til hygieneformål og til kroppssrengjøring
-  Armen til hodedusjen er kun laget for å holde hodedusjen. Den må ikke belastes med andre gjenstander!

Montagehenvisninger

Silpakningen som er levert med dusjen skal bygges inn for å forhindre at smuss spyles inn fra ledningsnett. Innspylt smuss kan påvirke funksjonen negativt og/eller kan medføre skader på hånddusjens funksjonsdeler. Hansgrohe påtar seg inget ansvar for skader som resulteres av dette.

Tekniske data

Driftstrykk	maks. 0,6 MPa
Anbefalt driftstrykk:	0,2 - 0,4 MPa
(1 MPa = 10 bar = 147 PSI)	
Varmtvannstemperatur	maks. 60°C
Termisk desinfisering:	maks. 70°C / 4 min

Produktet er utelukkende designet for drikkevann!

Symbolbeskrivelse



Mål (se side 18)



Service-deler (se side 20)



Gjennomstrømningsdiagram
(se side 18)







Rengjøring (se side 19) og
vedlagt brosjyre

Prøvermerke (se side _1i)





Указания за безопасност

-  При монтажа трябва да се носят ръкавици, за да се избегнат наранявания поради притискане или порязване.
-  Трябва да се избягва контакта на струите на разпръсквателя с чувствителни части на тялото (напр. очите). Между разпръсквателя и тялото трябва да се спазва достатъчно разстояние.
-  Позволено е използването на разпръсквателя само за къпане, хигиена и цели на почистване на тялото.
-  Рамото на разпръсквателя за главата е разработена само, за да държи разпръсквателя за главата, то не бива да се натоварва с други предмети!

Указания за монтаж

Опакованото заедно с разпръсквателя уплътнение с цедка трябва да се монтира, за да се избегне натрупване на замърсявания от водопроводната мрежа. Натрупването на замърсявания може да наруши функцията и/или да доведе до увреждания на функционалните части на разпръсквателя, Hansgrohe не носи отговорност за получените се по този начин щети.

Технически данни

Работно налягане: макс. 0,6 МПа
 Препоръчително работно налягане: 0,2 - 0,4 МПа
 (1 МПа = 10 bar = 147 PSI)
 Температура на горещата вода: макс. 60°C
 Термична дезинфекция: макс. 70°C / 4 мин

Продуктът е разработен само за питейна вода!

Описание на символите



Размери (вижте стр. 18)



Диаграма на потока
(вижте стр. 18)







Сервизни части (вижте стр. 20)



Почистване (вижте стр. 19) и приложена брошура

Контролен знак (вижте стр. _1i)

Udhëzime sigurie

-  Për të evituar lëndimet e pickimeve ose të prerjeve gjatë procesit të montimit duhet që të vishni doreza.
-  Kontakti i valëve të dushit me pjesët e ndjeshme të trupit (p.sh. me sytë) duhet që të shmanget. Midis dushit dhe trupit duhet që të mbahet një distancë e mjaftueshme.
-  Dushi duhet të përdoret vetëm për qëllimet e banjave, të higjienës dhe të larjes së trupit.
-  Mbatësjja e kokës së dushit është projektuar vetëm për mbajtjen e kokës së dushit dhe nuk duhet që të rëndohet me objekte të tjera!

Udhëzime për montimin

Sita që i kemi bashkëngjitur spërkatëses duhet përdorur për të evituar thithjen e papastërtive nga rrjeti i ujësllësit. Ndotjet mund të dëmtojnë pjesë funksionale të spërkatëses. Hansgrohe nuk merr përgjegjësinë për dëmet e shkaktuara në këtë mënyrë.

Të dhëna teknike

Presioni gjatë punës maks. 0,6 МПа
 Presioni i rekomanduar: 0,2 - 0,4 МПа
 (1 МПа = 10 bar = 147 PSI)
 Temperatura e ujit të ngrohtë maks. 60°C
 Dezinfirmim Termik: maks. 70°C / 4 min

Produkti është projektuar ekskluzivisht për ujë të pijshëm!

Përshkrimi i simbolit



Përmasat (shih faqen 18)



Diagrami i qarkullimit
(shih faqen 18)



Pjesët e servisit (shih faqen 20)



Pastrimi (shih faqen 19) dhe broshura bashkëngjitur

Shenja e kontrollit (shih faqen _1i)





تنبيهات الأمان

- ⚠ يجب إرتداء قفازات لليد أثناء التركيب لتجنب حدوث أخطار الإنحشار أو الجروح.
- ⚠ يجب تجنب حدوث إتصال مباشر بين الماء الخارج من رأس الدش وبين أجزاء الجسم الحساسة (مثل العينين). يجب وجود مسافة كافية بين رأس الدش والجسم.
- ⚠ يسمح باستخدام الدش فقط لأغراض الإستحمام، والأغراض الصحية، وتتنظيف الجسم.
- ⚠ وظيفة ذراع دش الرأس هي فقط الإمساك بدش الرأس، ولذلك يجب عدم التحميل عليه بأشياء أخرى.

تعليمات التركيب

يجب إدخال الحلقة الشبكية لحماية الدش اليدوي من الأوساخ التي تحملها شبكة المواسير. حيث تؤدي الأوساخ الواردة إلى حدوث أعطال أو / وقد تتسبب في تلف أجزاء من من الدش، ومثل هذه الأعطال تلغي كافة المطالبات الخاصة بالمسؤولية أو الضمان.

المواصفات الفنية

- ضغط التشغيل:
- الحد الأقصى 0,6 ميجاباسكال
- ضغط التشغيل الموصى به:
- 0,2 - 0,4 ميجاباسكال
- (1 ميجاباسكال = 10 بار = 147 PSI)
- درجة حرارة الماء الساخن:
- الحد الأقصى 60°C
- تعقيم حراري:
- الحد الأقصى 70°C / 4 الدقيقة
- المنتج مخصص فقط لماء الشرب!

وصف الرمز

أبعاد (راجع صفحة 18)



رسم للصرف

(راجع صفحة 18)



قطع الغيار (راجع صفحة 20)



التنظيف (راجع صفحة 19) والكتيب المرفق



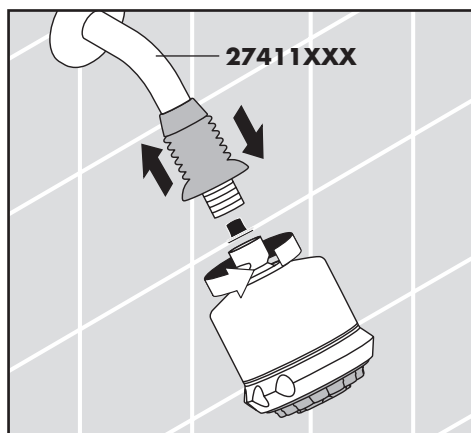
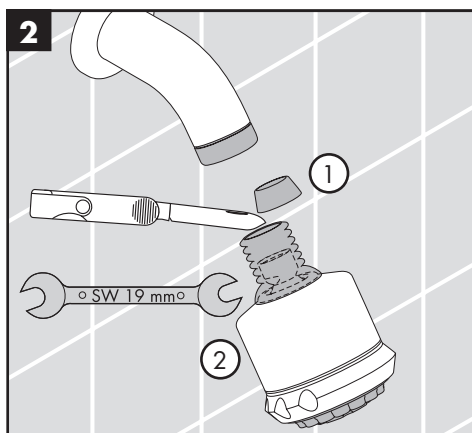
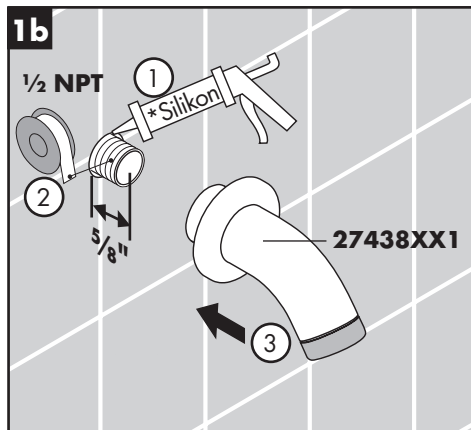
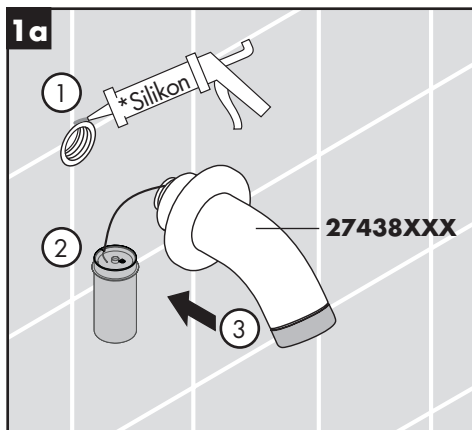

- * Silikon (essigsäurefrei!)
 Silicone (sans acide acétique!)
 Silicone (free from acetic acid!)
 Silicone (esente da acido acetico!)
 Silicona (¡libre de ácido acético!)
 Silicone (azijnzuurvrij!)
 Silikone (eddikesyre-fri)
 Silicone (sem ácido acético)
 Silikon (neutralny)
 Silikon (bez kyseliny octové!)
 Silikon (bez kyseliny octovej!)
 硅胶 (不含醋酸)
 Силикон (не содержит уксусной кислоты!)
 Szilikon (ecetsavmentes!)

- Silikonas (be acto rūgšties!)
 Silikon (ne sadrži kiseline)
 Silikon (asetik asit içermeyen)
 Silicon (fără acid acetic!)
 Σιλικόνη (δίχως οξικό οξύ!)
 Silikon (brez ocetne kisline)
 Silikoon (äädikhappeta!)
 Silikons (etiškābi nesaturošis!)
 Silikon (ne sadrži sirćetnu kiselinu!)
 Silikon (uten eddiksyre)
 Силикон (без оцетна киселина!)
 Silikon (pa acid uthulle!)

سيليكون (خالى من حمض الخليك!)



26606000 / 27475000 / 27438XXX

28496XXX

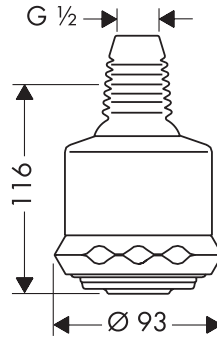
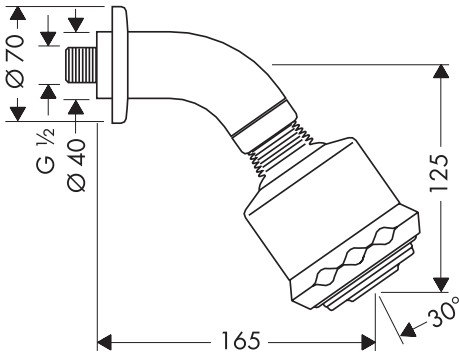

27438XX1

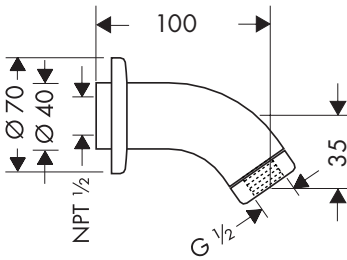

27475000 / 28496XXX

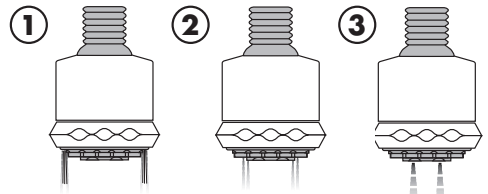
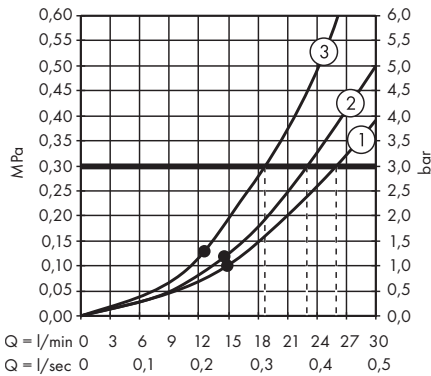



26606000

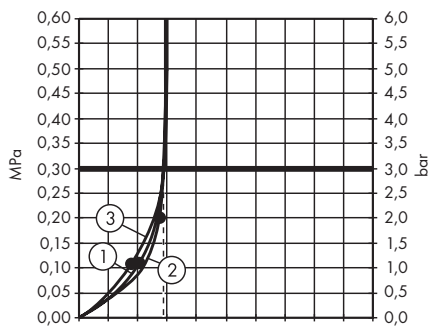

Q = l/min 0 3 6 9 12 15 18 21 24 27 30

Q = l/sec 0 0,1 0,2 0,3 0,4 0,5

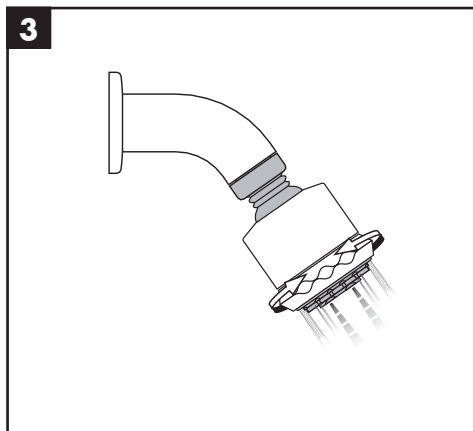
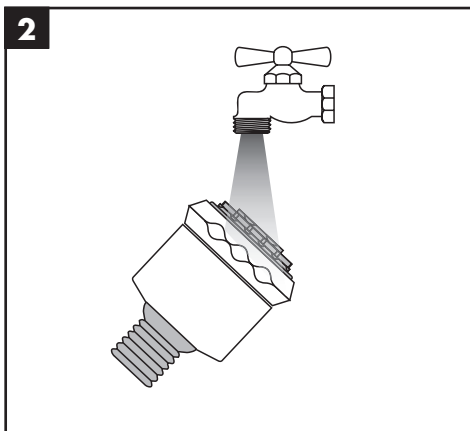
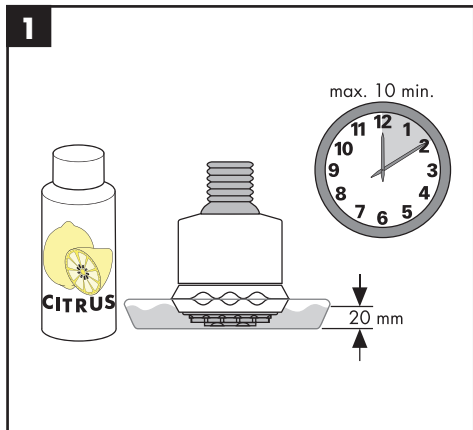
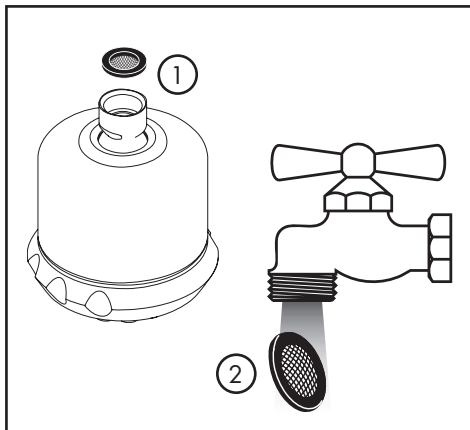
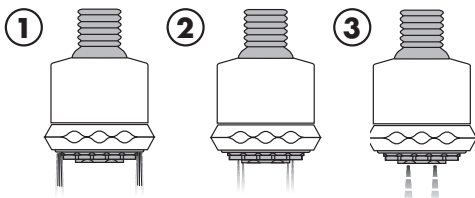

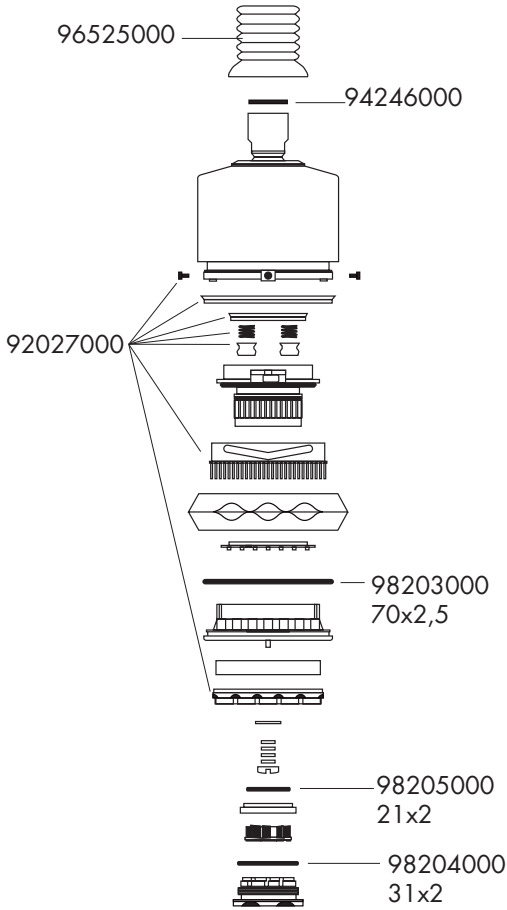

hansgrohe

Hansgrohe · Austraße 5 · 9 · D-77761 Schiltach · Telefon +49 (0) 78 36/51-1282 · Telefax +49 (0) 7836/511440
E-Mail: info@hansgrohe.com · Internet: www.hansgrohe.com

7/2016
9.07115.04