

8	9	10	11	12	13
1376	1548	1720	1892	2064	2236
-	-	-	-	-	-
1872	2106	2340	2574	2808	3000

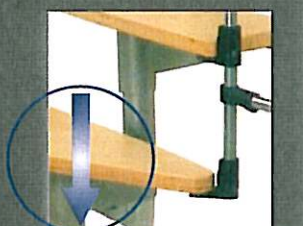

⊖ 172-233 mm

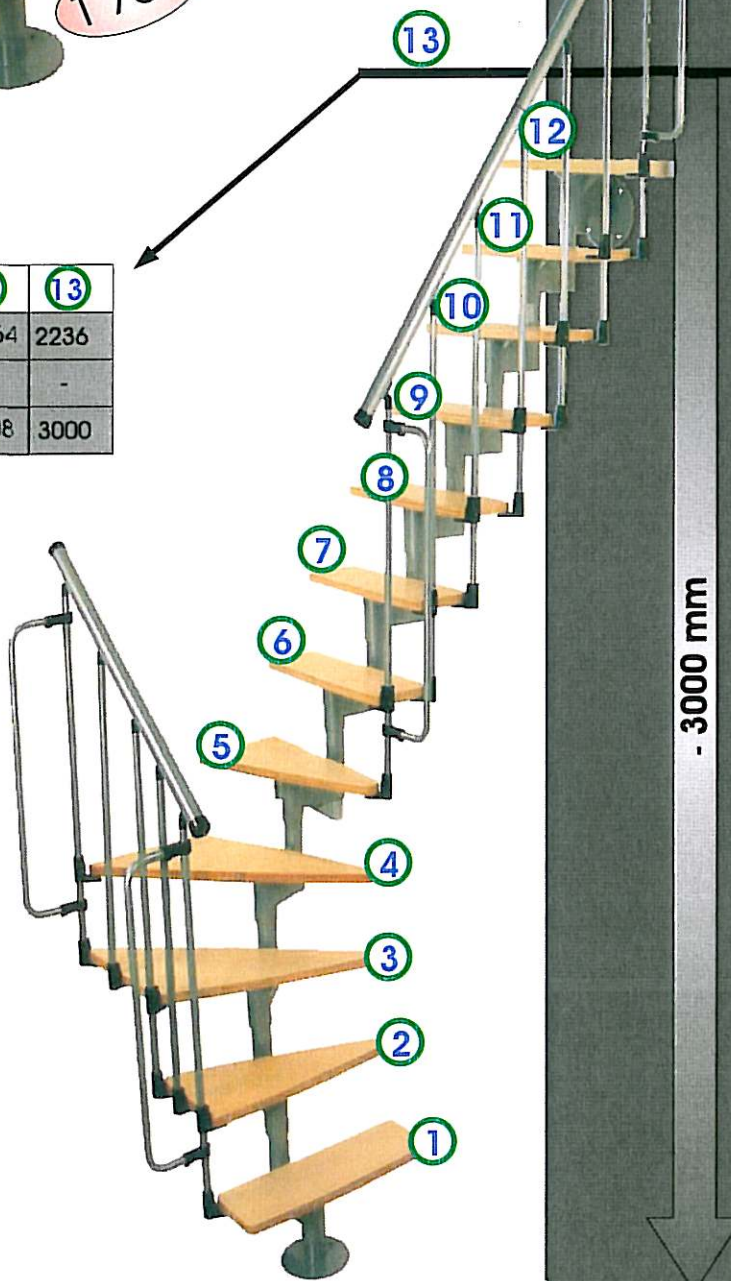

⊖ 200 kg 

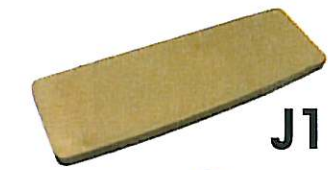

J1

12 x - 930034

12 x - 932053

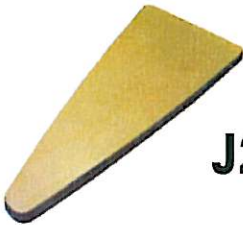

J2

2 x - 932035

2 x - 932054

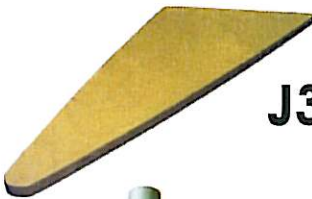

J3

2 x - 932036

2 x - 932055



J4

11 x - 921012



J5

1 x - 921013



J6

1 x - 920487



J7

1 x - 920485

Ø 22 x 995mm

J8

17 x - 932039



J9

4 x - 932037



J10

1 x - 921006

1 x - 921008



J11

1 x - 921007



J12

M8 x 1000 mm

3 x - 930706



J13

Ø50 x 952 mm

3 x - 932038

3 x - 931261



J14

Ø22 mm

17 x - 930631



J15

Ø35 mm

4 x - 932138



J16

Ø60 mm

11 x - 930851



J17

17 x - 932031



J18

34 x - 932032



J19

17 x - 913217



J20

5 x - 932137



J21

8 x - 930623

M10 x 70mm DIN 933



J22

2 x - 931060

M8 x 70mm DIN933



J23

15 x - 931735

M8 x 55mm DIN933



J24

2 x - 930656

M5 x 20mm DIN7991



J25

17 x - 930676

M10 x 8mm DIN914



J26

24 x - 931062

M6 x 6mm DIN914



J27

50 x - 930632

Ø5 x 30mm



J28

102 x - 930200

Ø5 x 25mm



J29

72 x - 931063

Ø3,9 x 16mm DIN7504P



J30

34 x - 931221

M8 x 55mm



J31

15 x - 931733

M6 DIN562



J32

50 x - 930633

M5 DIN934



J33

17 x - 930727

M8 DIN934



J34

6 x - 930233

M8 DIN6334



J35

2 x - 930679

M10 DIN1587



J36

2 x - 931879

Ø 30mm M10 DIN9021A



J37

8 x - 930600

Ø16mm M8 DIN125A



J38

19 x - 931078

Ø19mm M10 DIN125A



J39

2 x - 931061

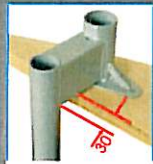
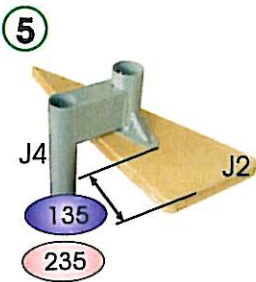
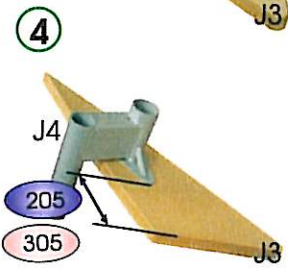
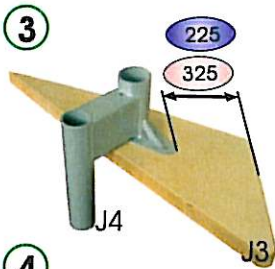
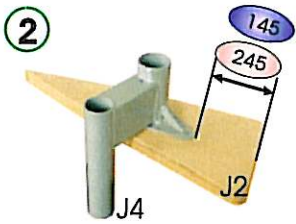
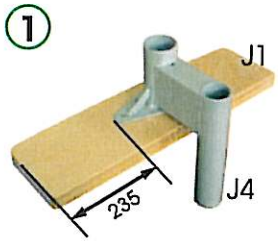

② 30 mm



③ 6 x J29

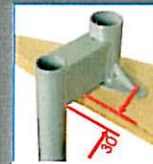
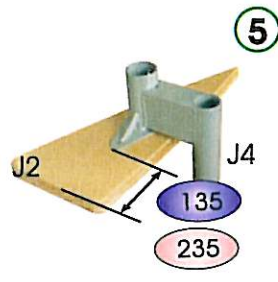
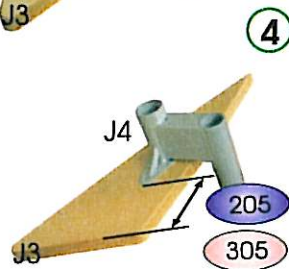
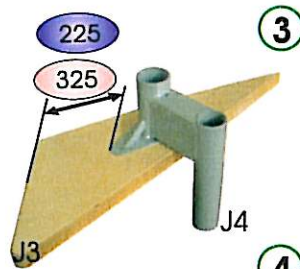
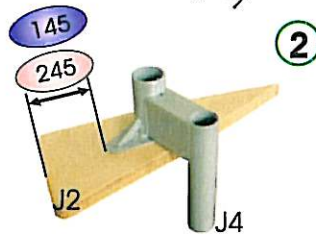
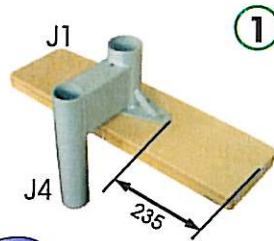

② 30 mm



③ 6 x J29

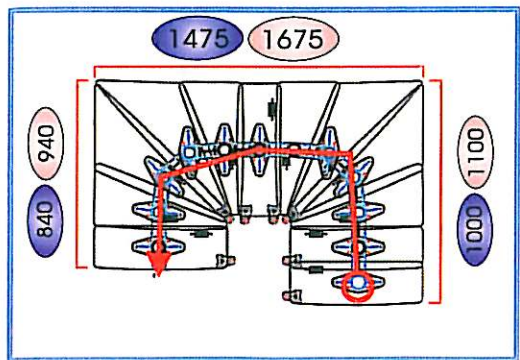
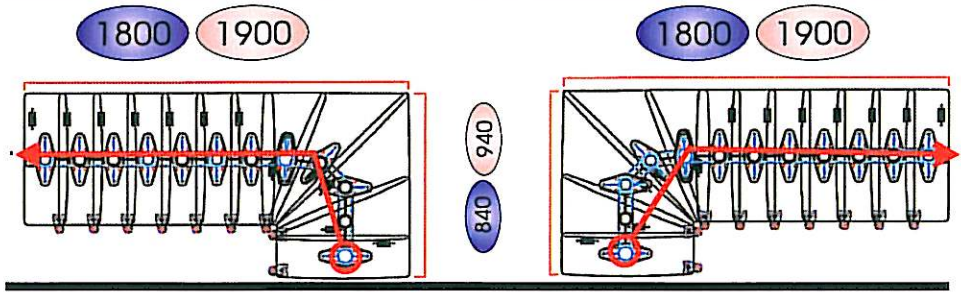
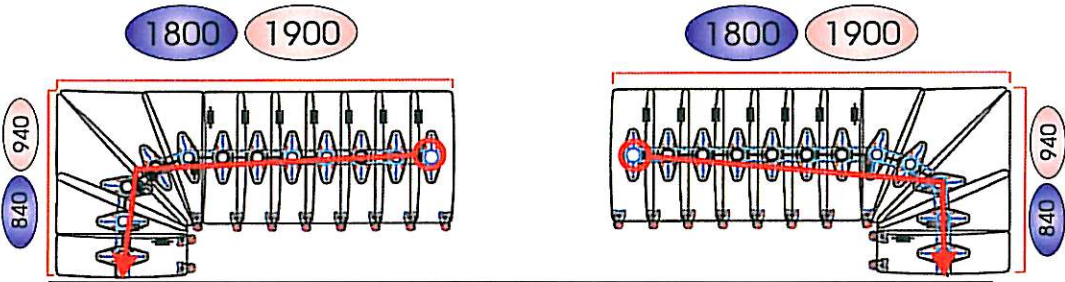
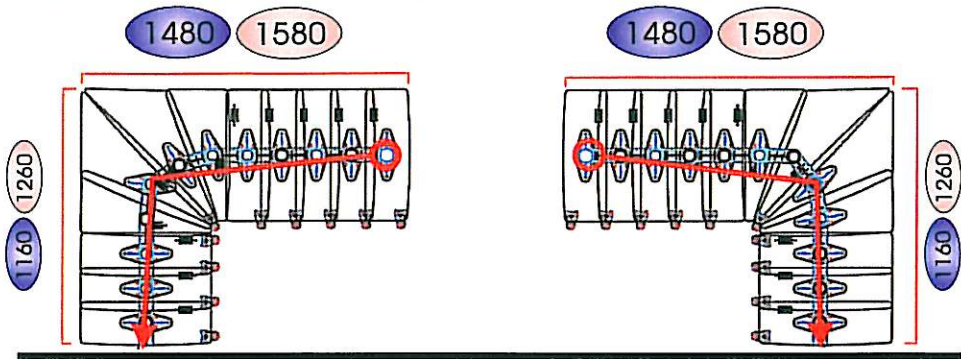
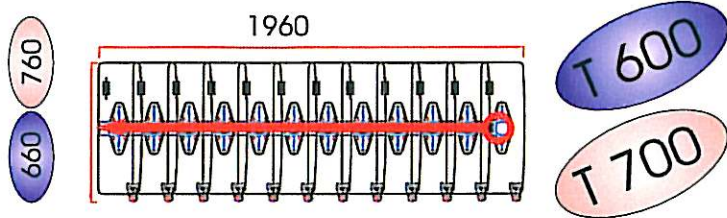

1

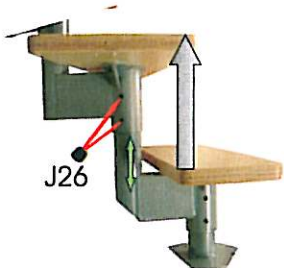

4 172 - 233 mm

5 2 x J26



6 J26

7 $\varnothing 12$ mm

8 13

9 0° / 180°

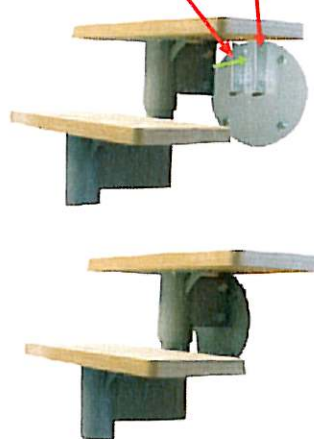
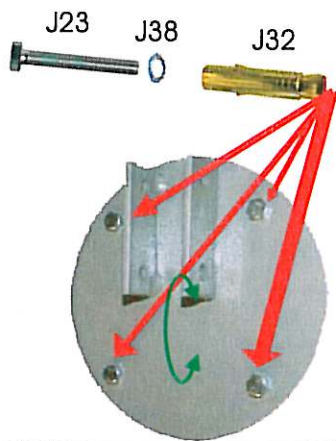

10 17

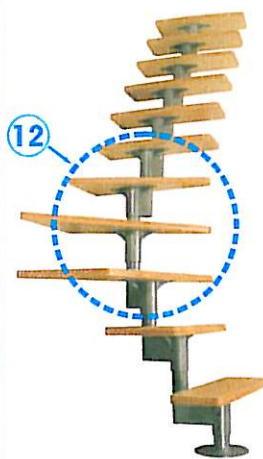

11 -

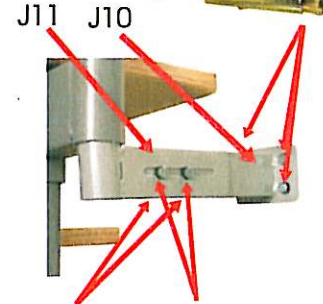

12 $\varnothing 12$ mm



13 13

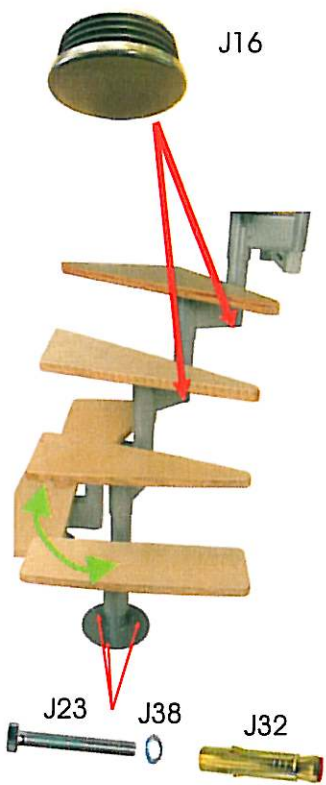

14 172 - 233 mm

15 Ø 12 mm

16 172 - 233 mm

17 13



18 -

19 3 x J28

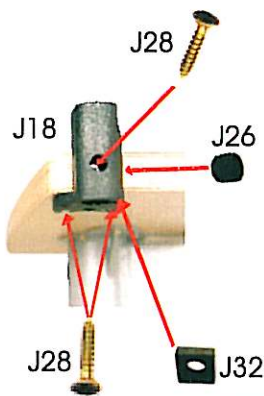

20 J32 - J26

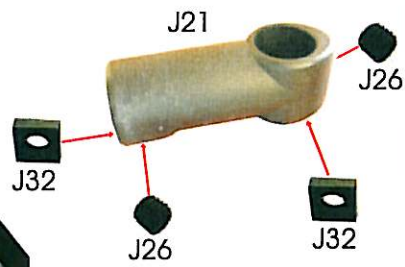

21 J32 - J26

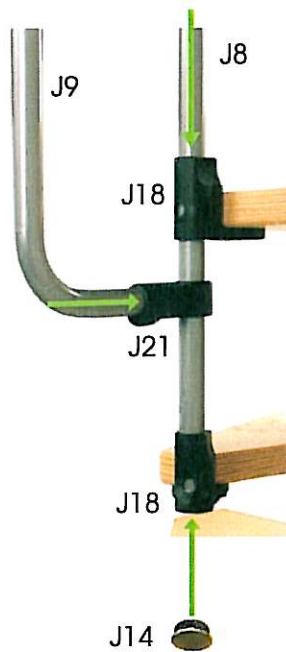

22 J32 - J26

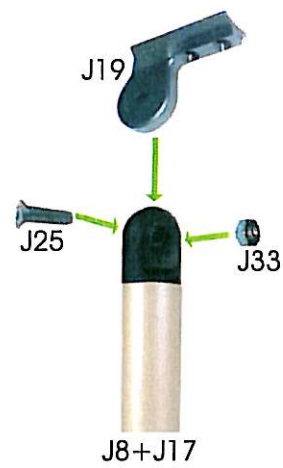

23 J25 - J33

