

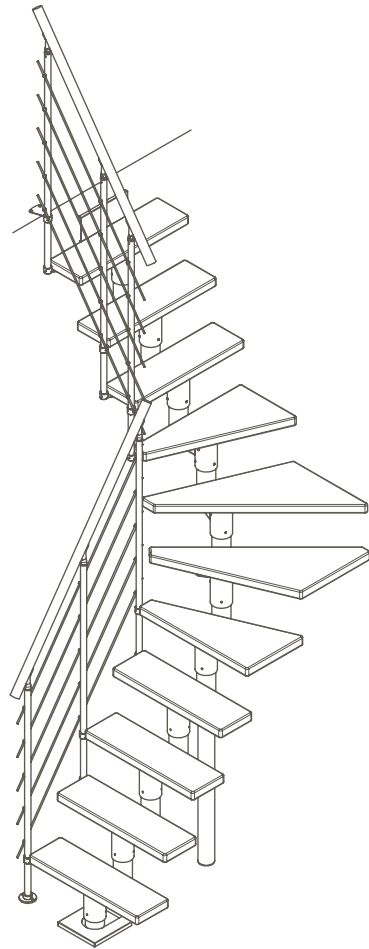

# DUBLIN

## DIMENSION

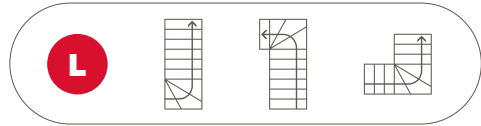
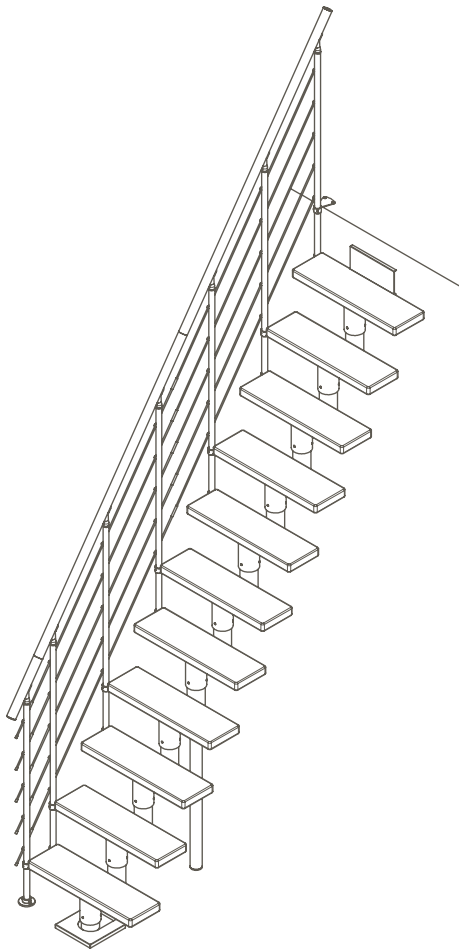
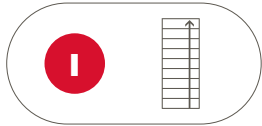

 Video: [www.dolle.com/dublin](http://www.dolle.com/dublin)

**Width 61 cm**

NO. OF TREADS	PAGE
11 treads . . . . .	7
12 treads . . . . .	9
13 treads . . . . .	11
14 treads . . . . .	15
15 treads . . . . .	19

**Width 71 cm**

NO. OF TREADS	PAGE
11 treads . . . . .	24
12 treads . . . . .	26
13 treads . . . . .	28
14 treads . . . . .	32
15 treads . . . . .	36

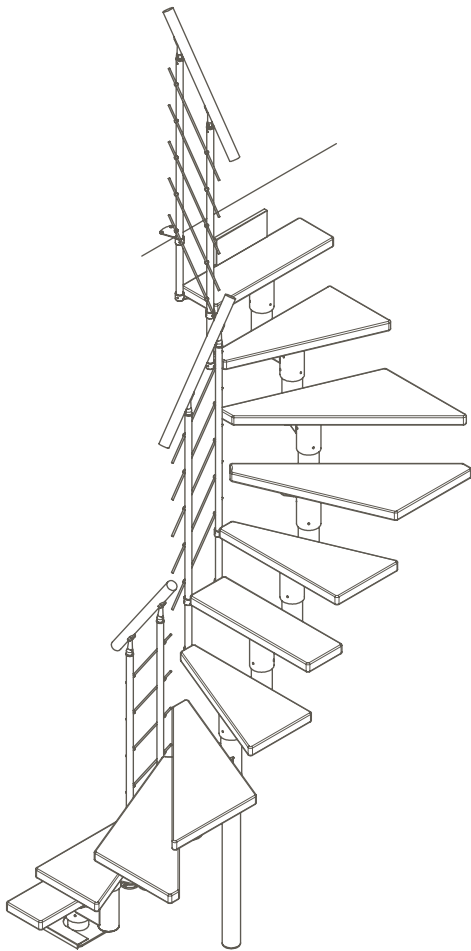
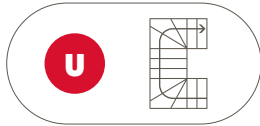

 Video: [www.dolle.com/dublin](http://www.dolle.com/dublin)

**Width 61 cm**

NO. OF TREADS	PAGE
11 treads . . . . .	7
12 treads . . . . .	9
13 treads . . . . .	11
14 treads . . . . .	15
15 treads . . . . .	19

**Width 71 cm**

NO. OF TREADS	PAGE
11 treads . . . . .	24
12 treads . . . . .	26
13 treads . . . . .	28
14 treads . . . . .	32
15 treads . . . . .	36

# STAIRCASE TERMINOLOGY





C1

E

G

H

M

	Staircase width w. 1 banister	Headroom	Going (of tread)	Height floor-to-floor	Upper floor opening length - min.
	Escalier à 1 rampe	Echappée	Giron	Hauteur sol-sol	Longueur de trémie min.
	Trappe bredde m. 1 gelænder	Frihøjde	Grund	Etagehøjde	Hulmål længde min.
	Trappbredd med 1 räcke	Frihöjd	Grund	Golv till golv höjd	Hålmått längd min.
	Treppenbreite inkl. 1 Geländer	Kopffreiheit	Auftrittsbreite	Geschosshöhe	Öffnungsgröße länge min.





N

O

P

R

R1

	Upper floor opening width - min.	Clear width	Pitch	Total going length	Total going width
	Largeur de trémie min.	Largeur de passage	Pente de l'escalier	Recul total - longueur	Recul total - largeur
	Hulmål bredde min.	Fri bredde	Stjghed/hældning	Udladning længde	Udladning bredde
	Hålmått bredd min.	Fri bredd	Hällning	Trapplängd	Trappbredd
	Öffnungsgröße breite min.	Durchgangsmaß	Winkel	Ausladung länge	Ausladung breite

S

T

V

W

X

	Rise height	Number of treads	Tread depth	Tread width	Tread thickness
	Hauteur de marche	Nombre de marches	Profondeur de marche	Largeur de marche	Epaisseur de marche
	Stigningshøjde	Antal trin	Trin dybde	Trin bredde	Trin tykkelse
	Steghöjd	Antal steg	Stegdjup	Stegbredd	Stegjocklek
	Steigungshöhe	Anzahl Stufen	Stufen tiefe	Stufen breite	Stufen Stärke

Z

	Deck thickness
	Epaisseur de dalle
	Dæk tykkelse
	Bjälklagstjocklek
	Deckenstärke

# DIMENSIONS

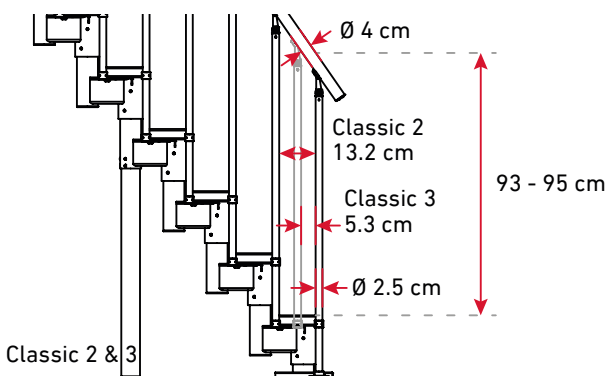
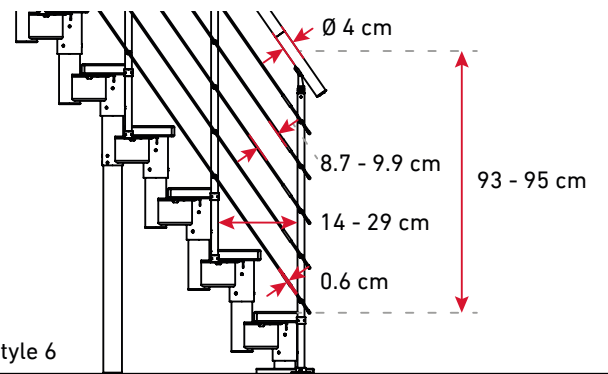
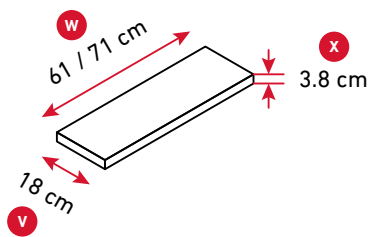
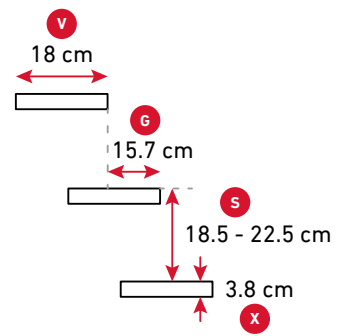
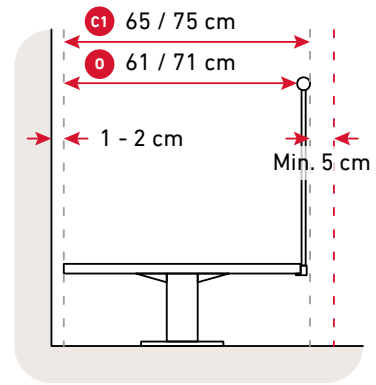
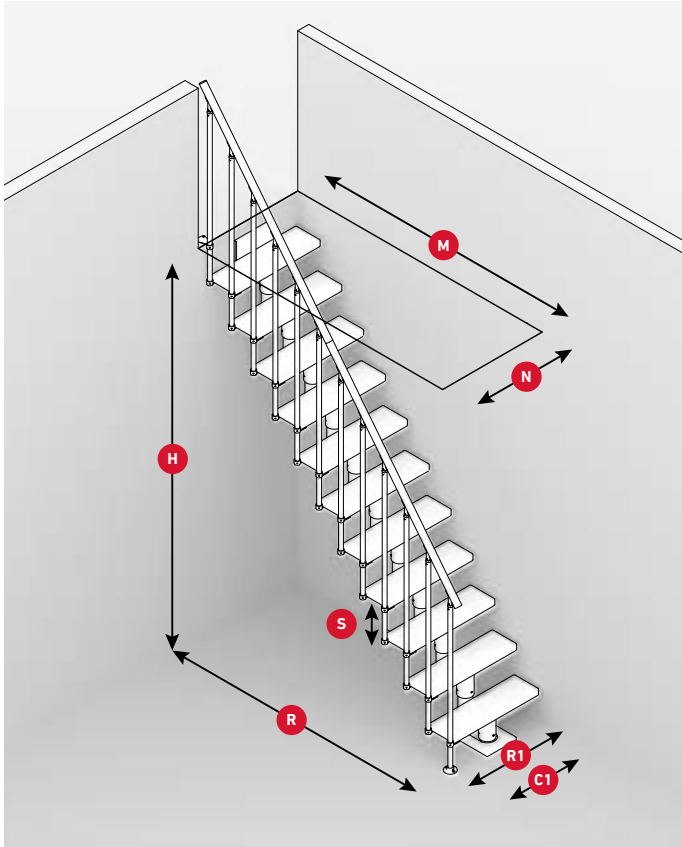

# DIMENSIONS

- H** (15T) 296 - 360 cm
- (14T) 277.5 - 337.5 cm
- (13T) 259 - 315 cm
- (12T) 240.5 - 292.5 cm
- (11T) 222 - 270 cm
- (10T) 203.5 - 247.5 cm
- (9T) 185 - 225 cm

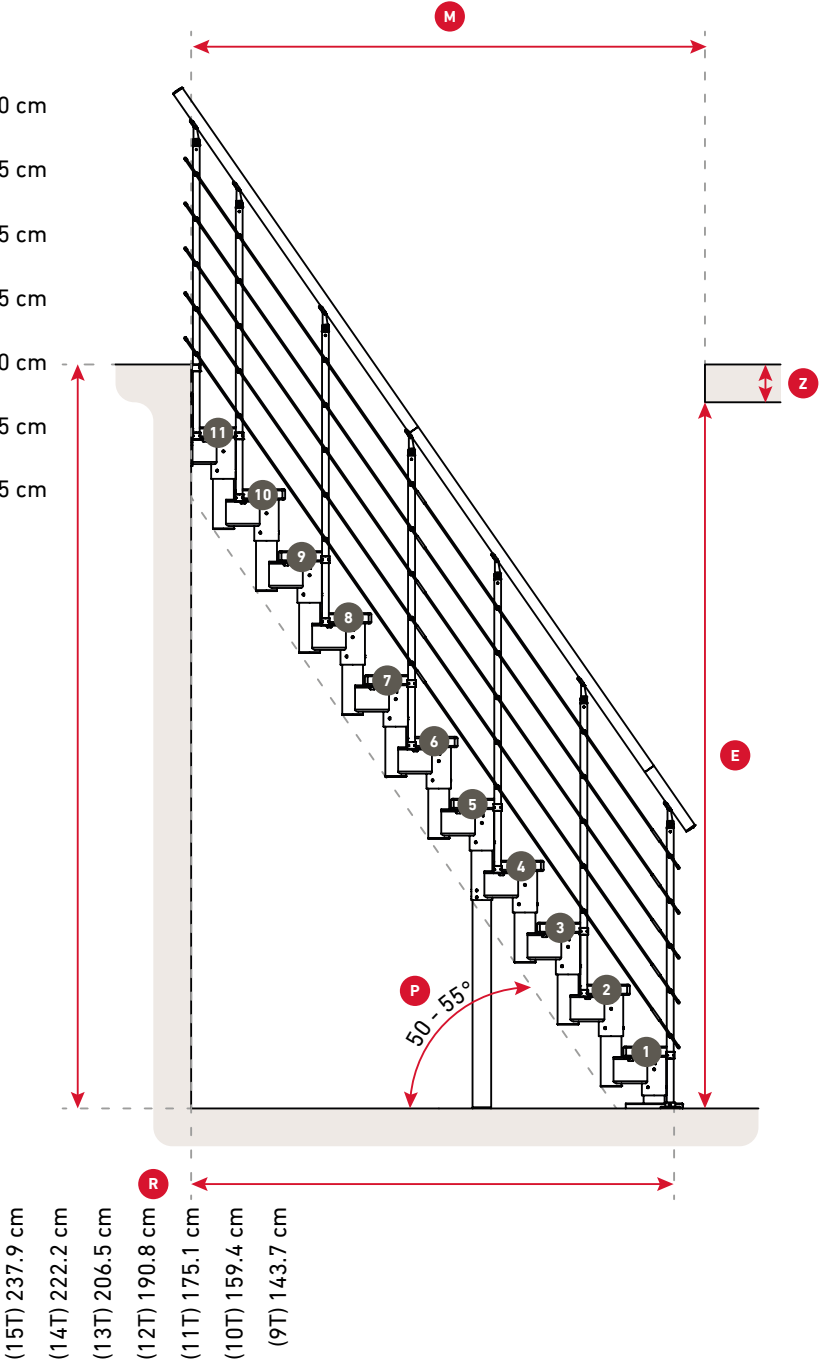

# DUBLIN 11 TREADS - WIDTH 61 CM

H 220 - 270 cm

— Staircase dimensions incl. handrail on 1 side

- - Floor opening size is defined based on 2 cm space to wall, 5 cm space for hand, 19 cm rise height, 25 cm deck thickness, 203 cm headspace.

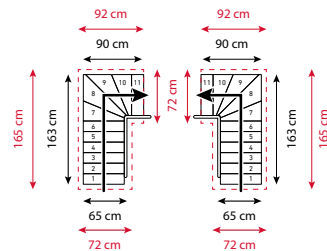
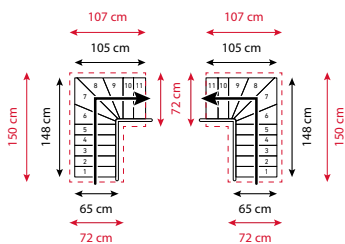
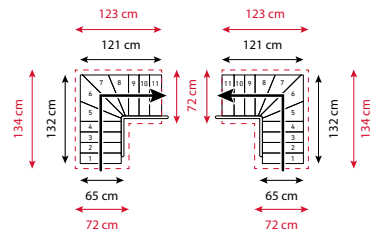
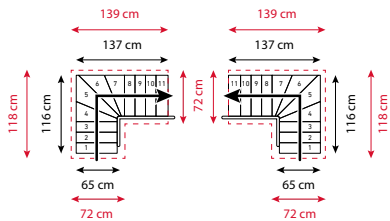
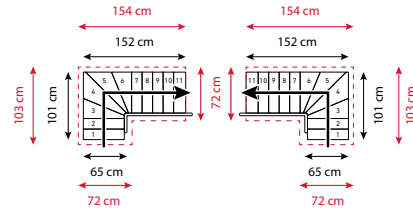
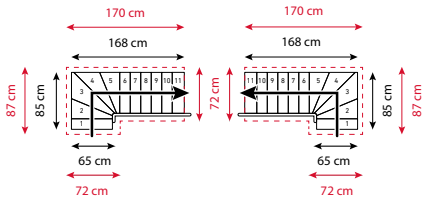
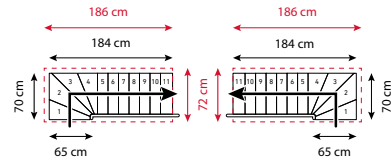
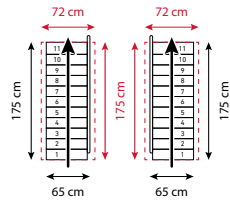

# DUBLIN 11 TREADS - WIDTH 61 CM

**H** 220 - 270 cm — Staircase dimensions incl. handrail on 1 side

--- Floor opening size is defined based on 2 cm space to wall, 5 cm space for hand, 19 cm rise height, 25 cm deck thickness, 203 cm headspace.

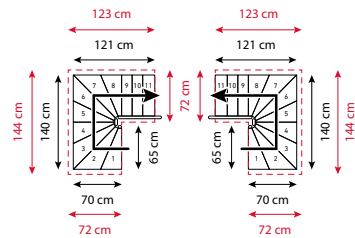
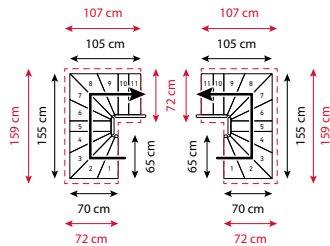
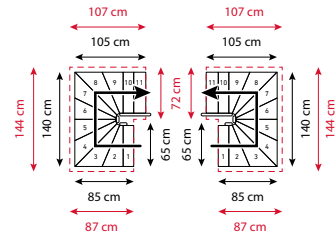
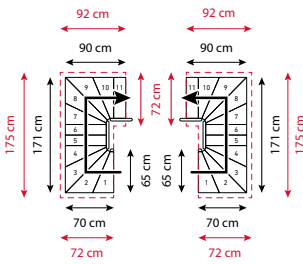
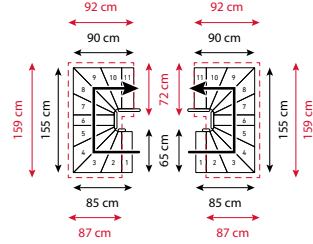
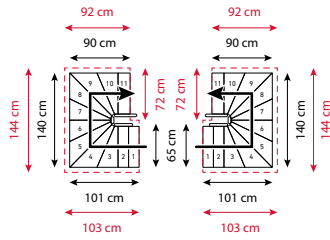



# DUBLIN 12 TREADS - WIDTH 61 CM

**H** 240.5 - 292.5 cm

— Staircase dimensions incl. handrail on 1 side

- - Floor opening size is defined based on 2 cm space to wall, 5 cm space for hand, 19 cm rise height, 25 cm deck thickness, 203 cm headspace.

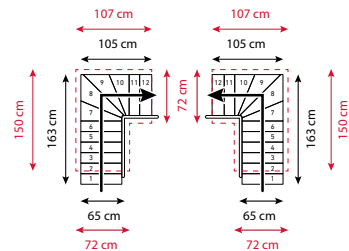
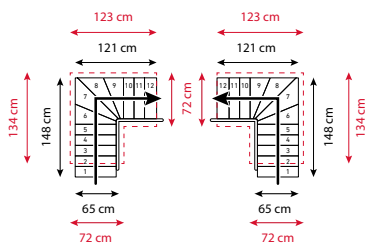
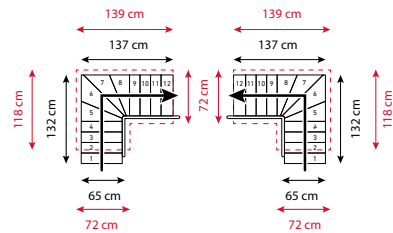
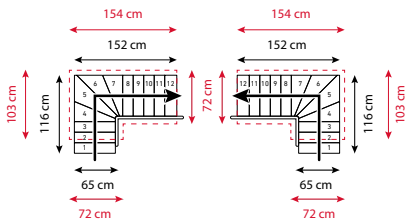
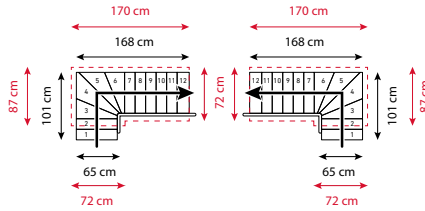
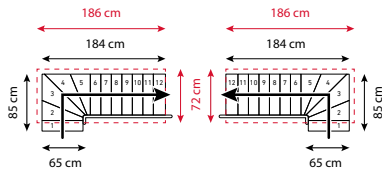
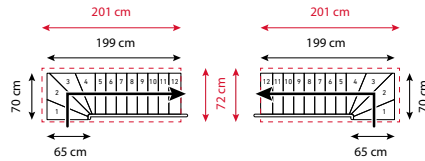
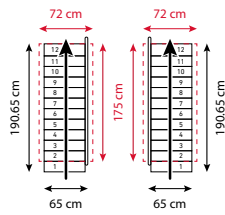

# DUBLIN 12 TREADS - WIDTH 61 CM

H 240.5 - 292.5 cm

— Staircase dimensions incl. handrail on 1 side

- - Floor opening size is defined based on 2 cm space to wall, 5 cm space for hand, 19 cm rise height, 25 cm deck thickness, 203 cm headspace.

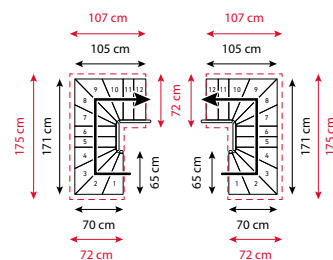
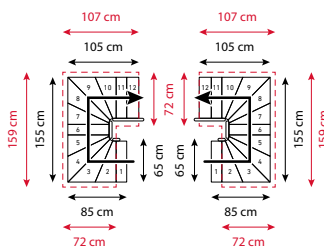
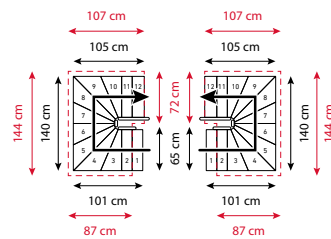
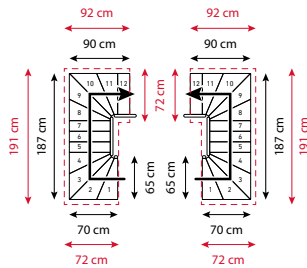
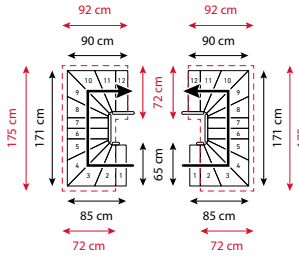
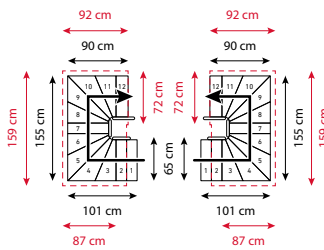
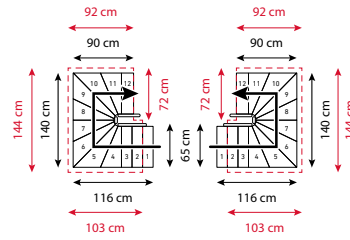
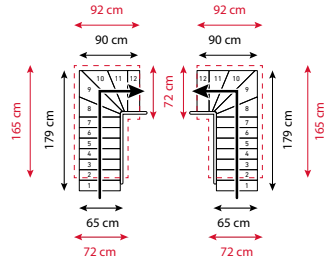

# DUBLIN 12 TREADS - WIDTH 61 CM

**H** 240.5 - 292.5 cm — Staircase dimensions incl. handrail on 1 side — Floor opening size is defined based on 2 cm space to wall, 5 cm space for hand, 19 cm rise height, 25 cm deck thickness, 203 cm headspace.

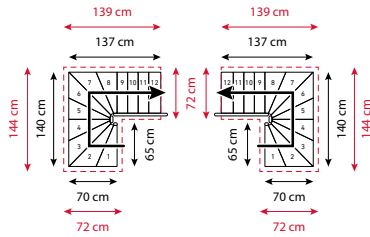
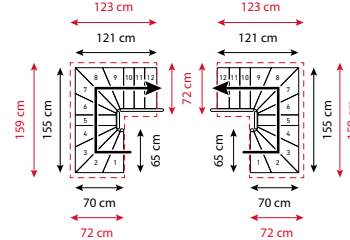
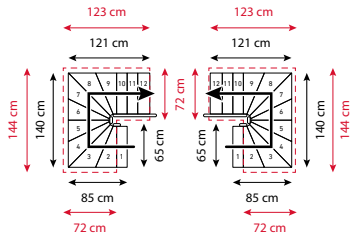

# DUBLIN 13 TREADS - WIDTH 61 CM

**H** 259 - 315 cm — Staircase dimensions incl. handrail on 1 side — Floor opening size is defined based on 2 cm space to wall, 5 cm space for hand, 19 cm rise height, 25 cm deck thickness, 203 cm headspace.

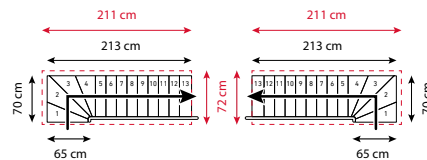
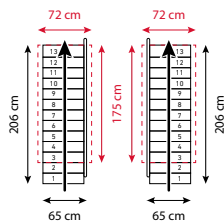

# DUBLIN 13 TREADS - WIDTH 61 CM

H 259 - 315 cm

— Staircase dimensions incl. handrail on 1 side

- - - Floor opening size is defined based on 2 cm space to wall, 5 cm space for hand, 19 cm rise height, 25 cm deck thickness, 203 cm headspace.

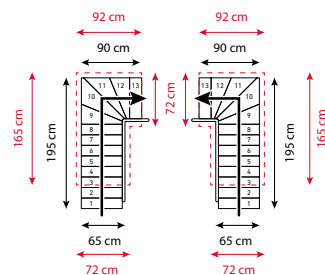
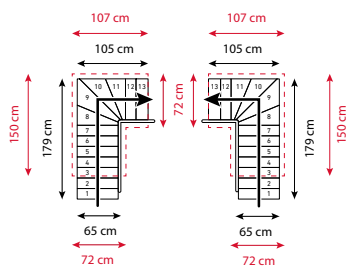
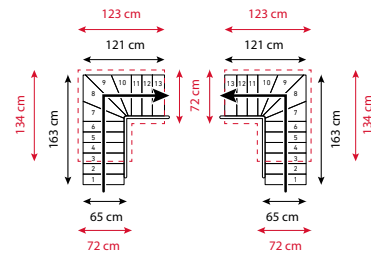
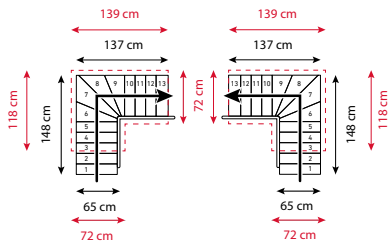
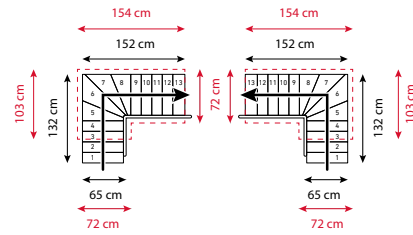
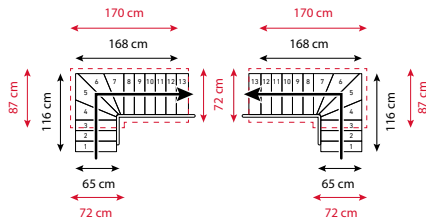
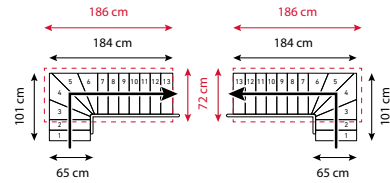
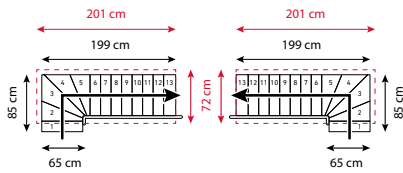

# DUBLIN 13 TREADS - WIDTH 61 CM

H 259 - 315 cm

— Staircase dimensions incl. handrail on 1 side

- - - Floor opening size is defined based on 2 cm space to wall, 5 cm space for hand, 19 cm rise height, 25 cm deck thickness, 203 cm headspace.

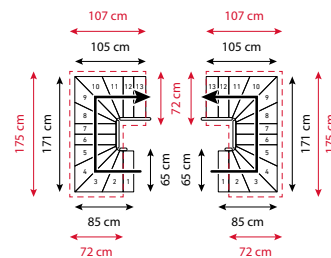
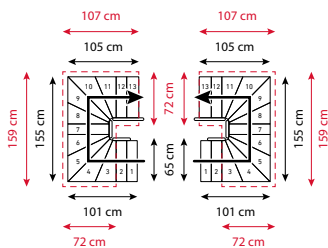
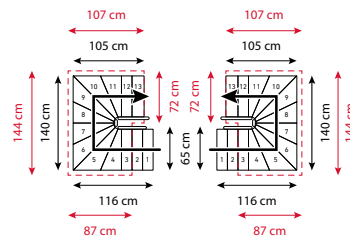
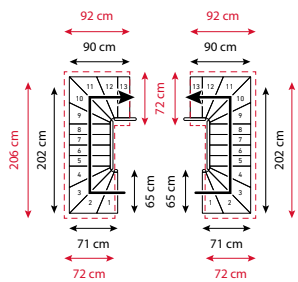
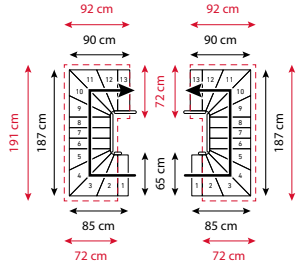
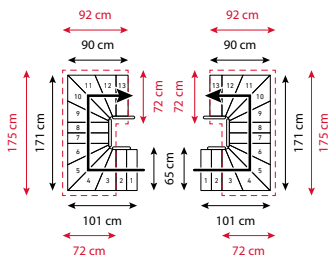
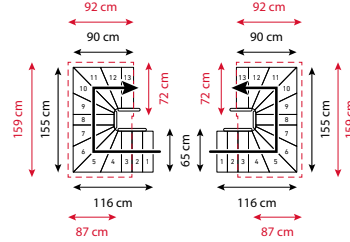
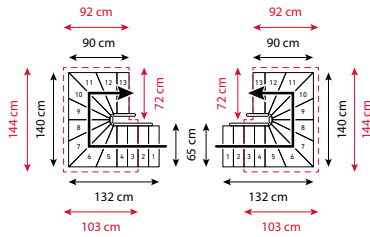

# DUBLIN 13 TREADS - WIDTH 61 CM

H 259 - 315 cm

— Staircase dimensions incl. handrail on 1 side

- - - Floor opening size is defined based on 2 cm space to wall, 5 cm space for hand, 19 cm rise height, 25 cm deck thickness, 203 cm headspace.

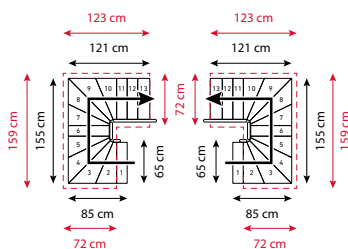
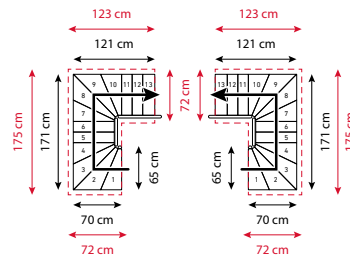
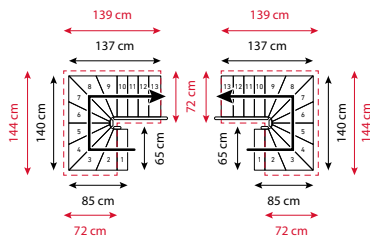
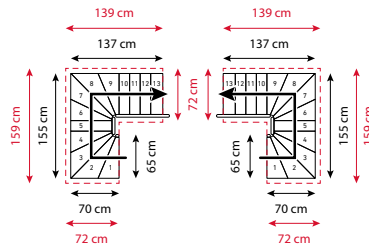
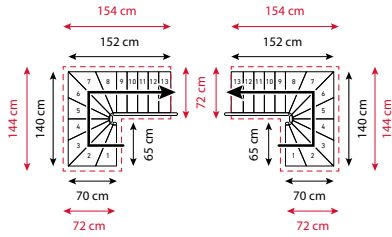
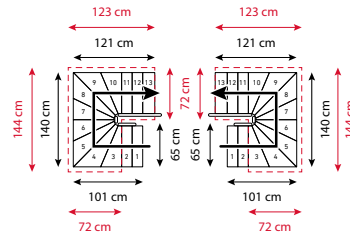
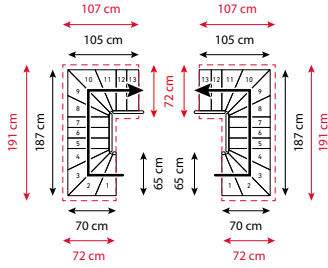

# DUBLIN 14 TREADS - WIDTH 61 CM

H 277.5 - 337.5 cm

— Staircase dimensions incl. handrail on 1 side

- - Floor opening size is defined based on 2 cm space to wall, 5 cm space for hand, 19 cm rise height, 25 cm deck thickness, 203 cm headspace.

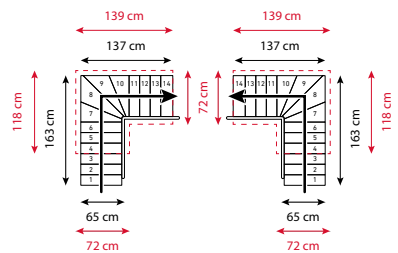
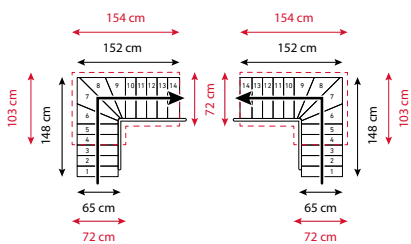
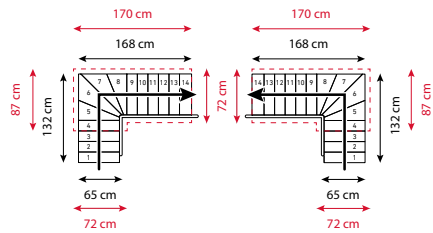
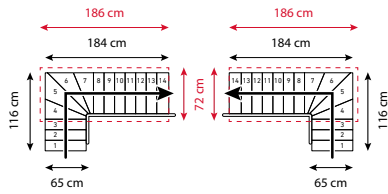
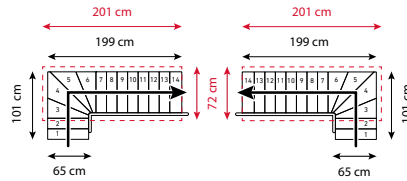
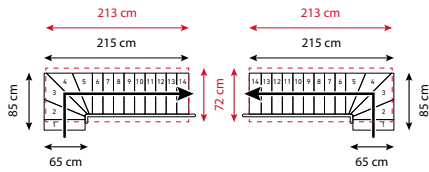
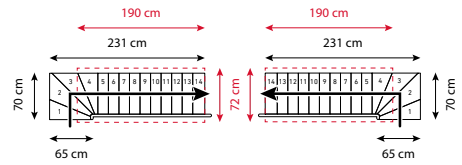
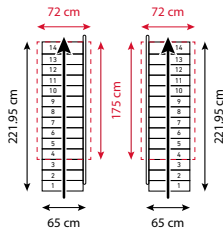

# DUBLIN 14 TREADS - WIDTH 61 CM

H 277.5 - 337.5 cm

— Staircase dimensions incl. handrail on 1 side

- - Floor opening size is defined based on 2 cm space to wall, 5 cm space for hand, 19 cm rise height, 25 cm deck thickness, 203 cm headspace.





# DUBLIN 14 TREADS - WIDTH 61 CM

H 277.5 - 337.5 cm

— Staircase dimensions incl. handrail on 1 side

- - Floor opening size is defined based on 2 cm space to wall, 5 cm space for hand, 19 cm rise height, 25 cm deck thickness, 203 cm headspace.

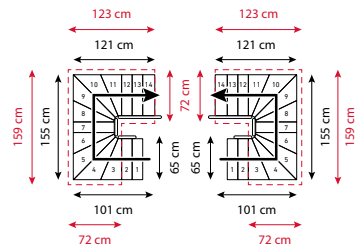
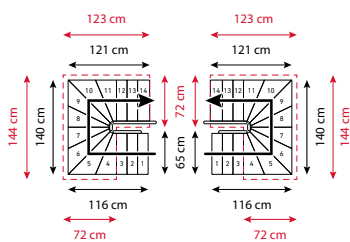
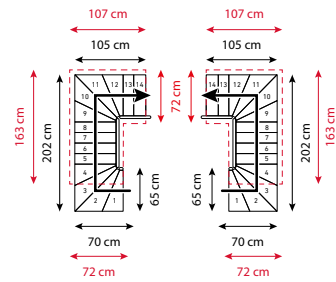
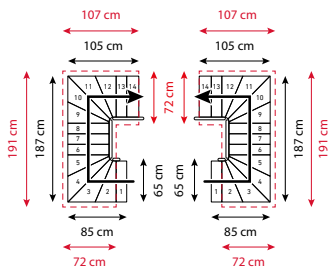
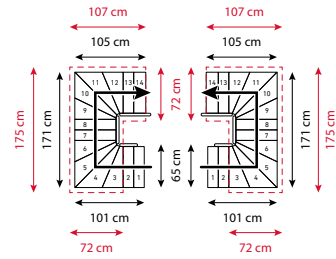
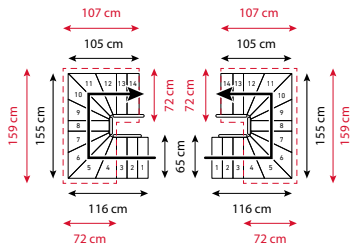
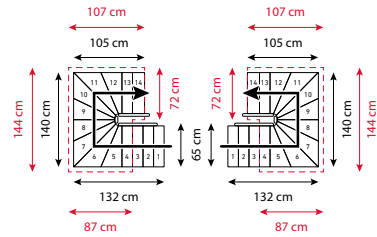
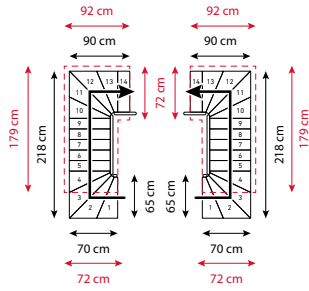

# DUBLIN 14 TREADS - WIDTH 61 CM

H 277.5 - 337.5 cm

— Staircase dimensions incl. handrail on 1 side

- - Floor opening size is defined based on 2 cm space to wall, 5 cm space for hand, 19 cm rise height, 25 cm deck thickness, 203 cm headspace.

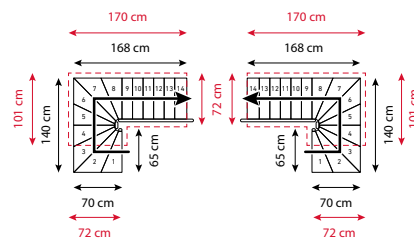
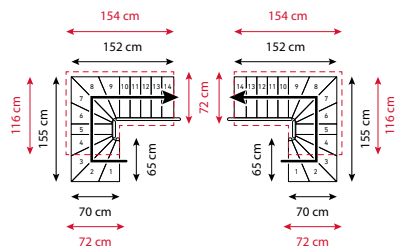
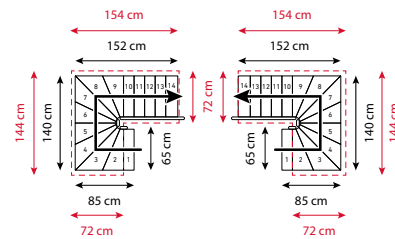
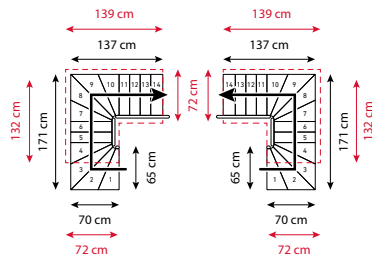
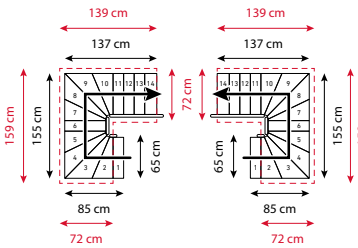
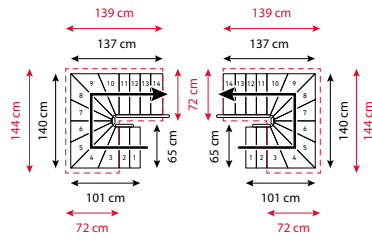
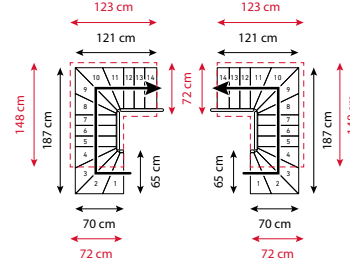
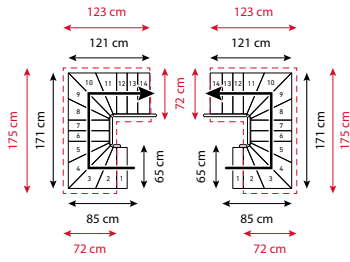

# DUBLIN 15 TREADS - WIDTH 61 CM

**H** 296 - 360 cm — Staircase dimensions incl. handrail on 1 side

--- Floor opening size is defined based on 2 cm space to wall, 5 cm space for hand, 19 cm rise height, 25 cm deck thickness, 203 cm headspace.

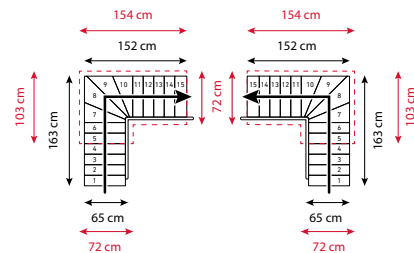
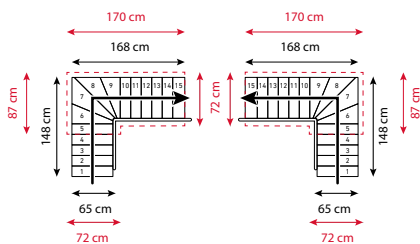
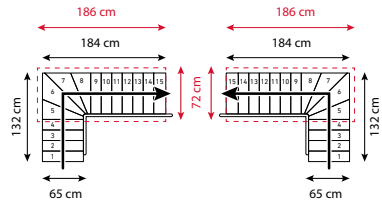
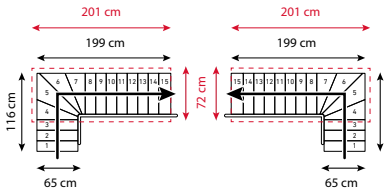
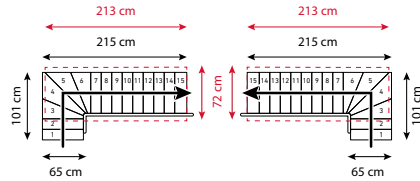
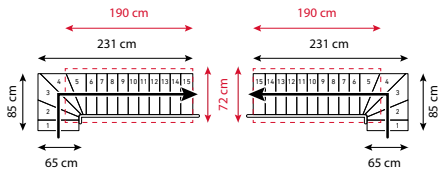
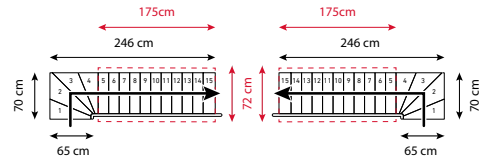
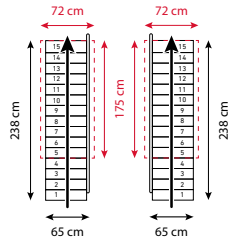

# DUBLIN 15 TREADS - WIDTH 61 CM

H 296 - 360 cm

— Staircase dimensions incl. handrail on 1 side

- - - Floor opening size is defined based on 2 cm space to wall, 5 cm space for hand, 19 cm rise height, 25 cm deck thickness, 203 cm headspace.

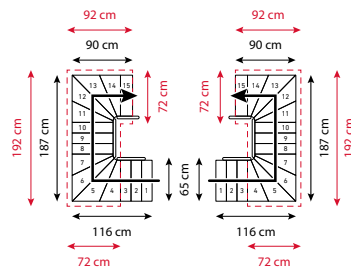
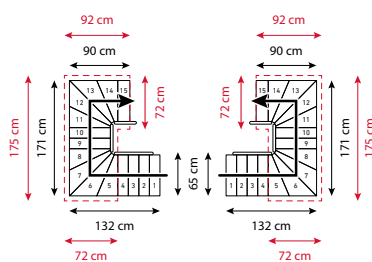
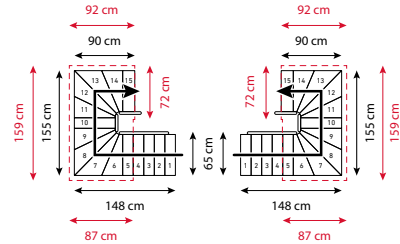
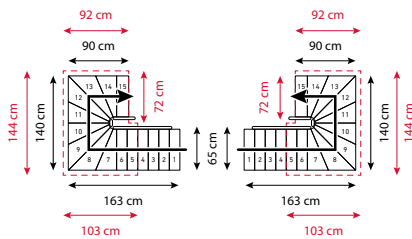
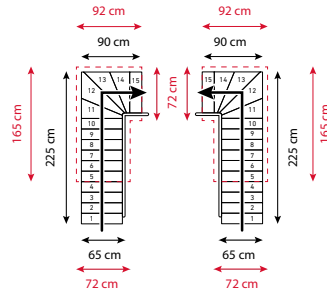
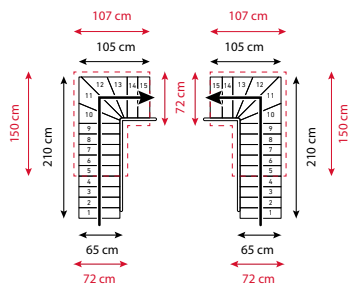
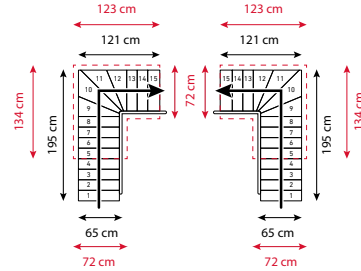
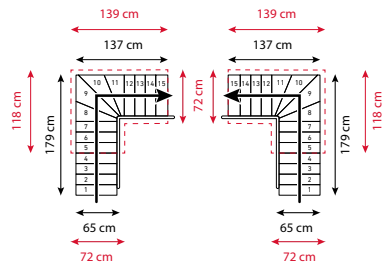

# DUBLIN 15 TREADS - WIDTH 61 CM

H 296 - 360 cm

— Staircase dimensions incl. handrail on 1 side

- - - Floor opening size is defined based on 2 cm space to wall, 5 cm space for hand, 19 cm rise height, 25 cm deck thickness, 203 cm headspace.

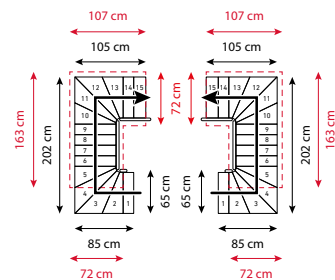
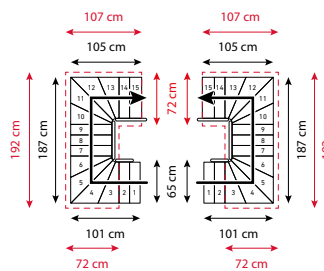
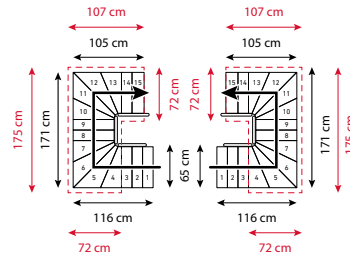
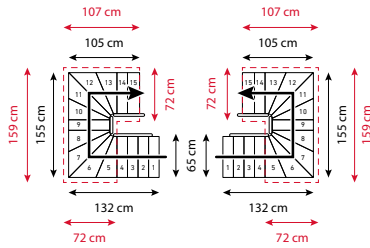
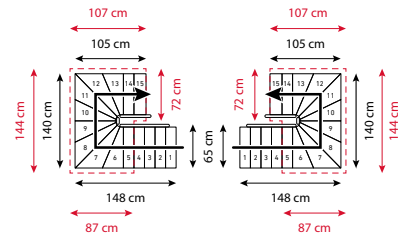
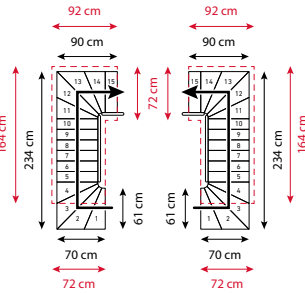
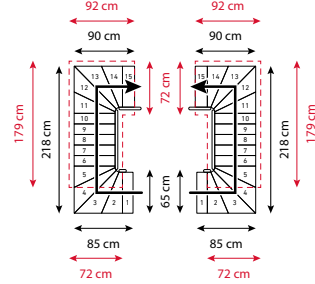
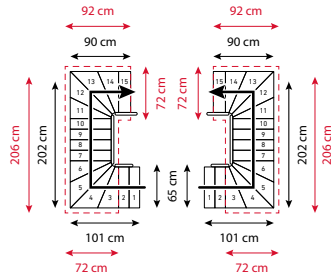

# DUBLIN 15 TREADS - WIDTH 61 CM

H 296 - 360 cm

— Staircase dimensions incl. handrail on 1 side

- - - Floor opening size is defined based on 2 cm space to wall, 5 cm space for hand, 19 cm rise height, 25 cm deck thickness, 203 cm headspace.

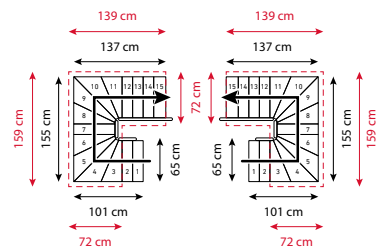
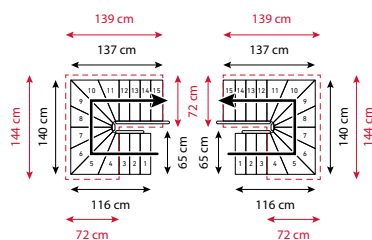
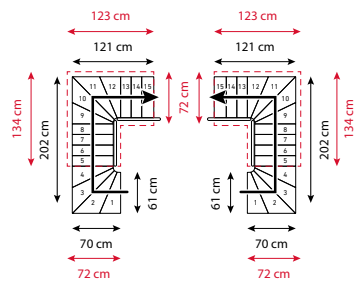
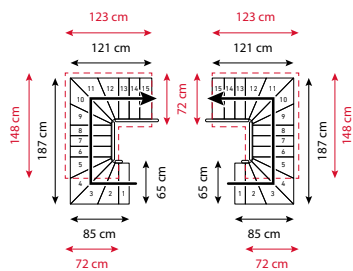
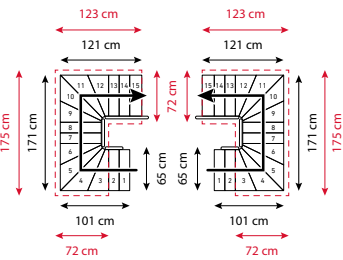
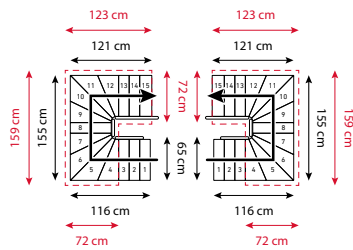
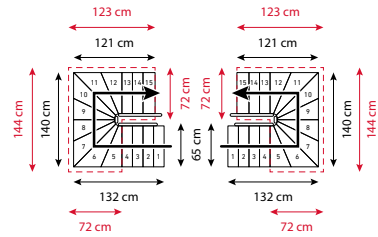
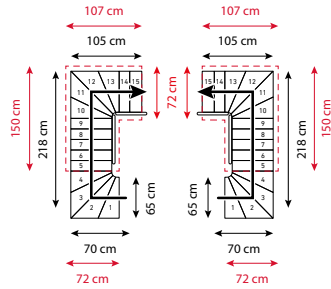

# DUBLIN 15 TREADS - WIDTH 61 CM

H 296 - 360 cm

— Staircase dimensions incl. handrail on 1 side

- - Floor opening size is defined based on 2 cm space to wall, 5 cm space for hand, 19 cm rise height, 25 cm deck thickness, 203 cm headspace.

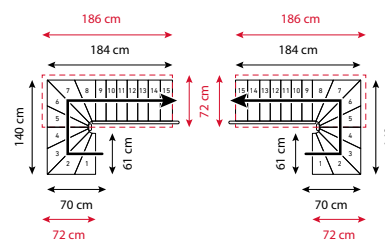
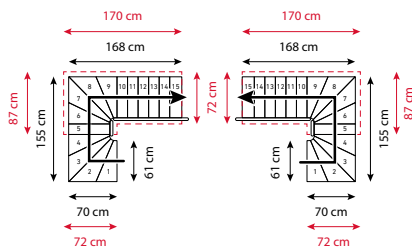
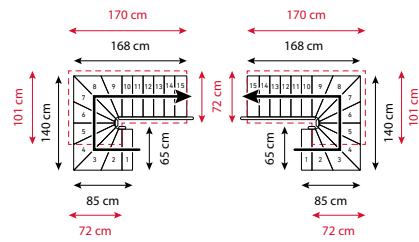
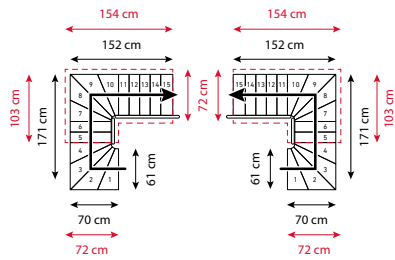
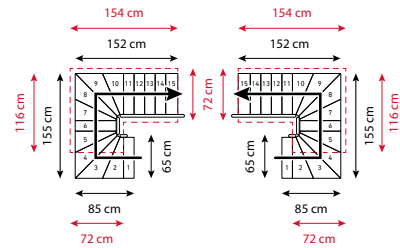
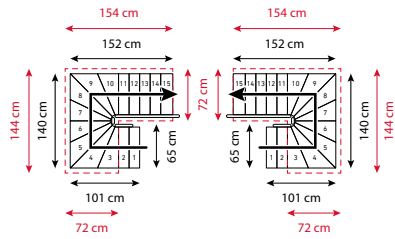
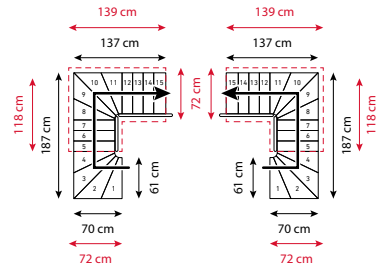
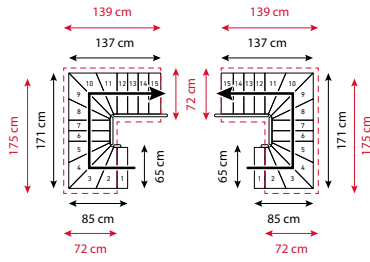

# DUBLIN 11 TREADS - WIDTH 71 CM

**H** 222 - 270 cm — Staircase dimensions incl. handrail on 1 side

--- Floor opening size is defined based on 2 cm space to wall, 5 cm space for hand, 19 cm rise height, 25 cm deck thickness, 203 cm headspace.

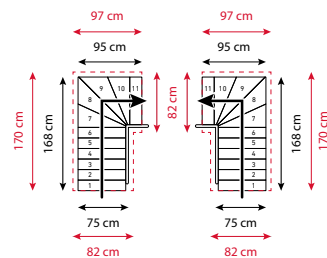
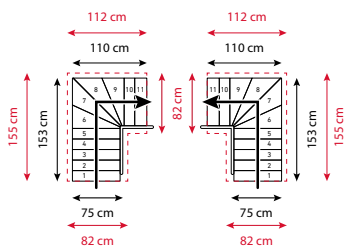
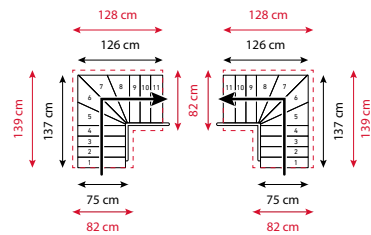
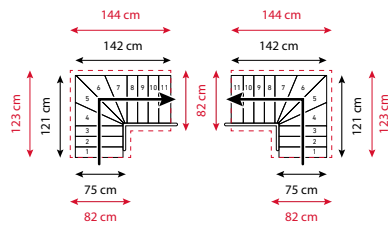
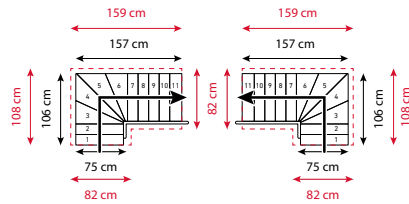
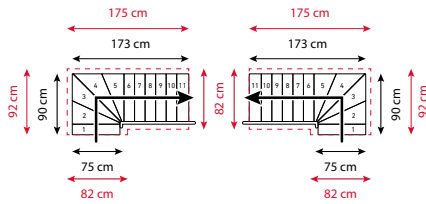
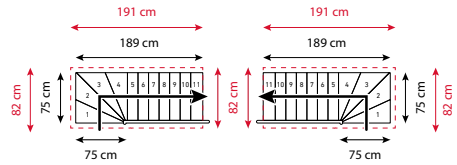
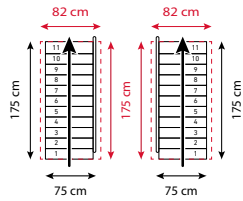



# DUBLIN 11 TREADS - WIDTH 71 CM

H 222 - 270 cm

— Staircase dimensions incl. handrail on 1 side

- - - Floor opening size is defined based on 2 cm space to wall, 5 cm space for hand, 19 cm rise height, 25 cm deck thickness, 203 cm headspace.

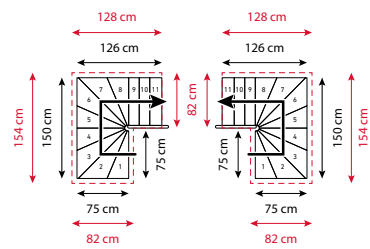
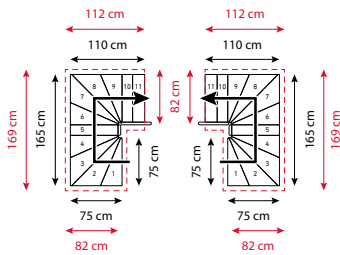
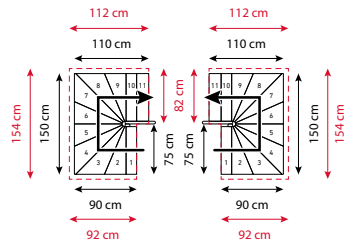
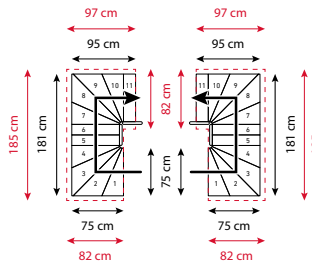
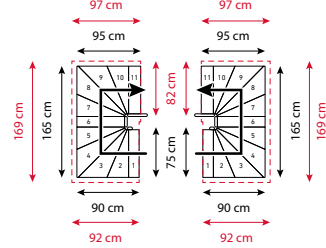
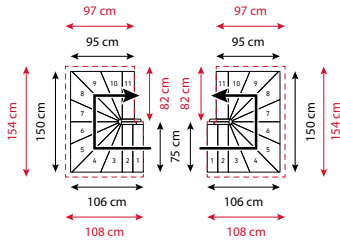

# DUBLIN 12 TREADS - WIDTH 71 CM

H 240.5 - 292.5 cm

— Staircase dimensions incl. handrail on 1 side

- - Floor opening size is defined based on 2 cm space to wall, 5 cm space for hand, 19 cm rise height, 25 cm deck thickness, 203 cm headspace.

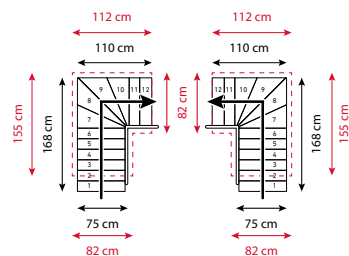
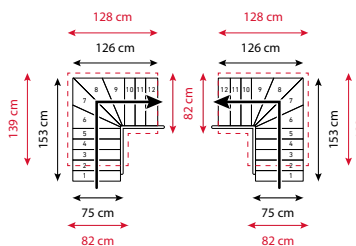
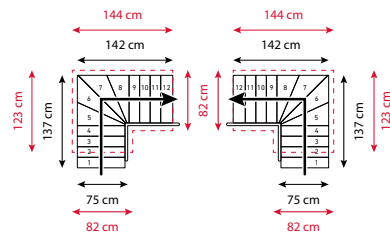
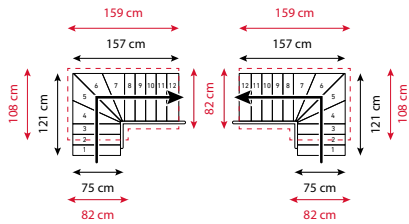
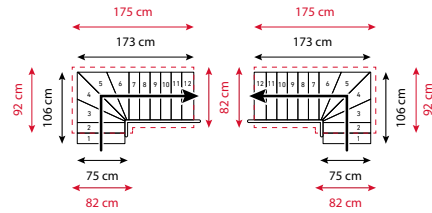
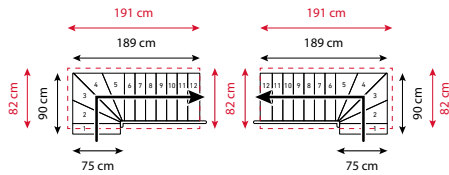
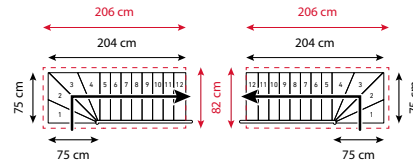
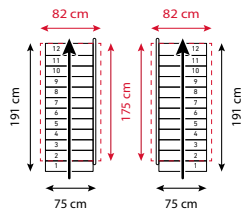

# DUBLIN 12 TREADS - WIDTH 71 CM

H 240.5 - 292.5 cm

— Staircase dimensions incl. handrail on 1 side

- - Floor opening size is defined based on 2 cm space to wall, 5 cm space for hand, 19 cm rise height, 25 cm deck thickness, 203 cm headspace.



# DUBLIN 12 TREADS - WIDTH 71 CM

**H** 240.5 - 292.5 cm — Staircase dimensions incl. handrail on 1 side

--- Floor opening size is defined based on 2 cm space to wall, 5 cm space for hand, 19 cm rise height, 25 cm deck thickness, 203 cm headspace.

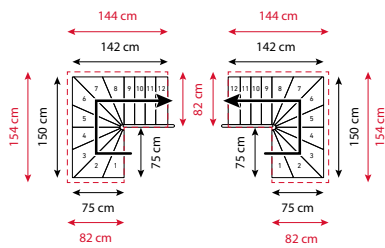
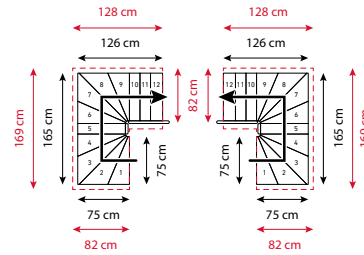
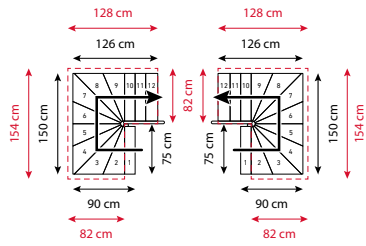

# DUBLIN 13 TREADS - WIDTH 71 CM

**H** 259 - 315 cm — Staircase dimensions incl. handrail on 1 side

--- Floor opening size is defined based on 2 cm space to wall, 5 cm space for hand, 19 cm rise height, 25 cm deck thickness, 203 cm headspace.

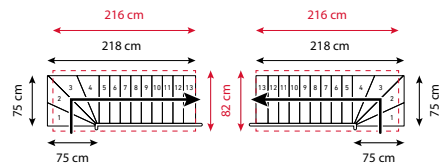
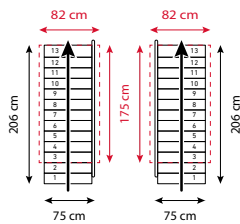

# DUBLIN 13 TREADS - WIDTH 71 CM

H 259 - 315 cm

— Staircase dimensions incl. handrail on 1 side

- - - Floor opening size is defined based on 2 cm space to wall, 5 cm space for hand, 19 cm rise height, 25 cm deck thickness, 203 cm headspace.

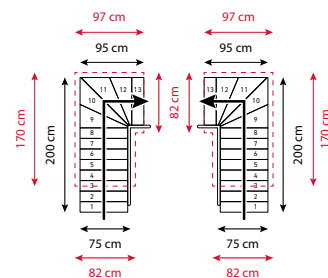
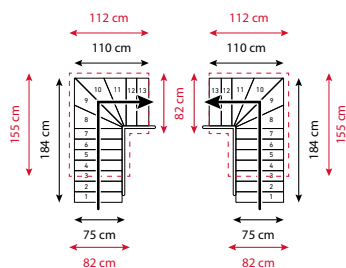
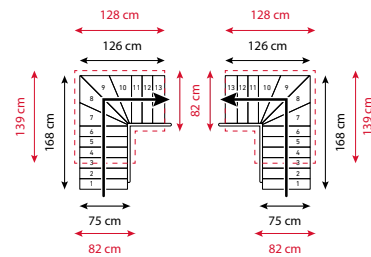
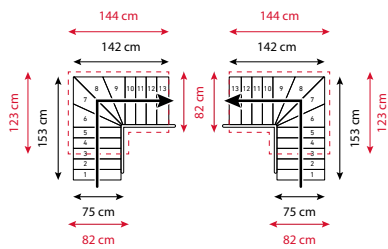
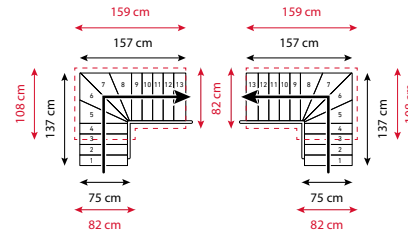
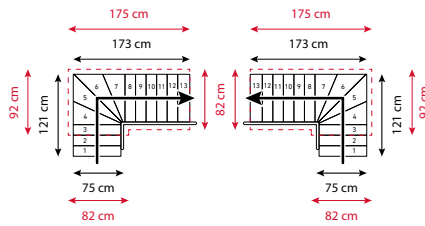
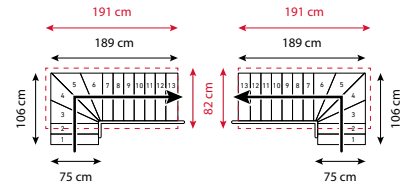
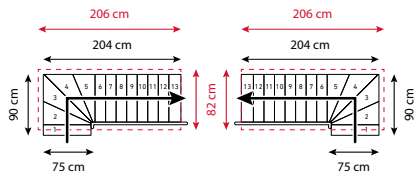

# DUBLIN 13 TREADS - WIDTH 71 CM

H 259 - 315 cm

— Staircase dimensions incl. handrail on 1 side

- - - Floor opening size is defined based on 2 cm space to wall, 5 cm space for hand, 19 cm rise height, 25 cm deck thickness, 203 cm headspace.

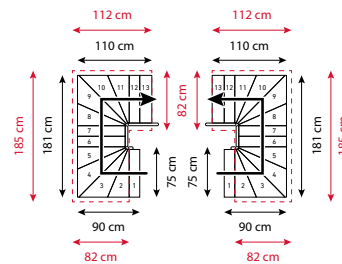
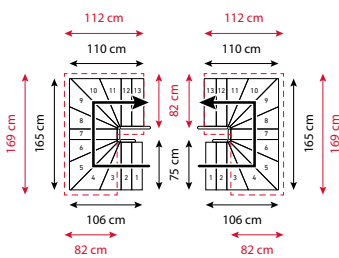
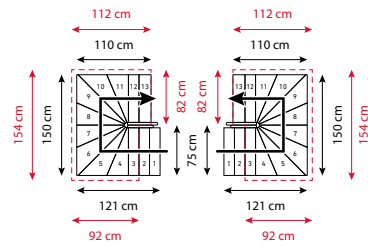
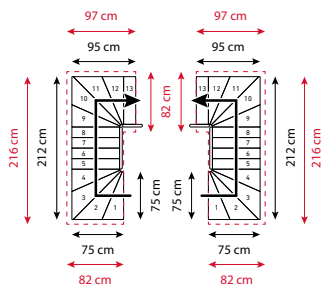
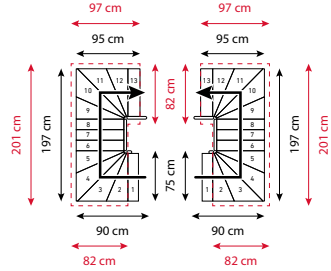
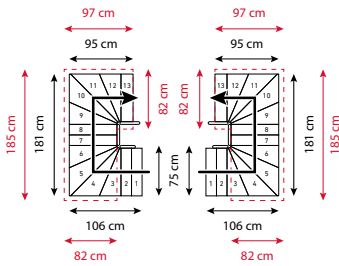
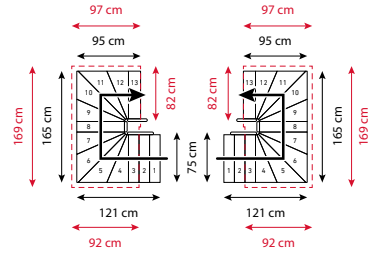
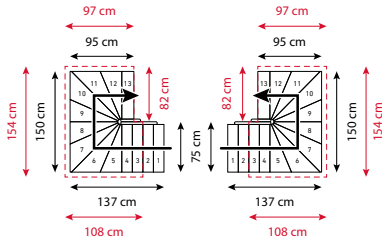

# DUBLIN 13 TREADS - WIDTH 71 CM

H 259 - 315 cm

— Staircase dimensions incl. handrail on 1 side

- - - Floor opening size is defined based on 2 cm space to wall, 5 cm space for hand, 19 cm rise height, 25 cm deck thickness, 203 cm headspace.

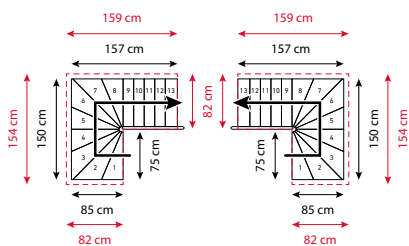
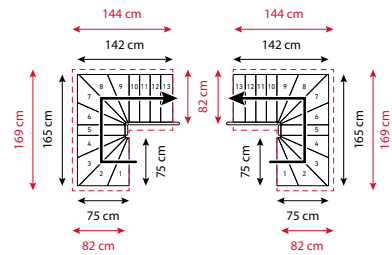
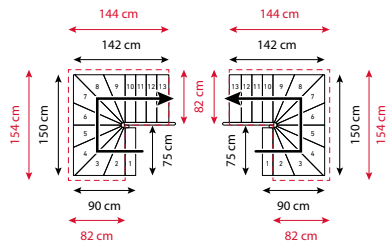
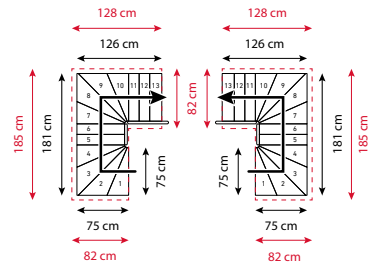
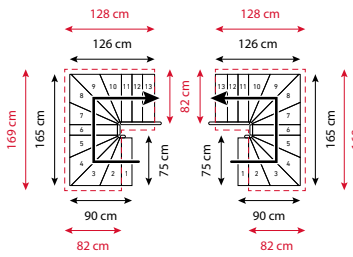
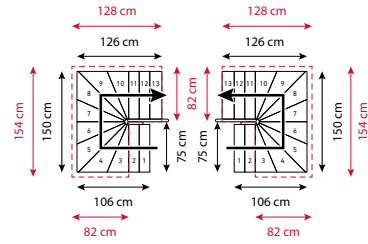
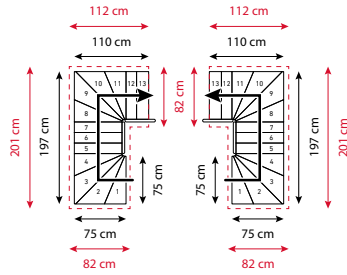

# DUBLIN 14 TREADS - WIDTH 71 CM

H 277.5 - 337.5 cm

— Staircase dimensions incl. handrail on 1 side

- - Floor opening size is defined based on 2 cm space to wall, 5 cm space for hand, 19 cm rise height, 25 cm deck thickness, 203 cm headspace.

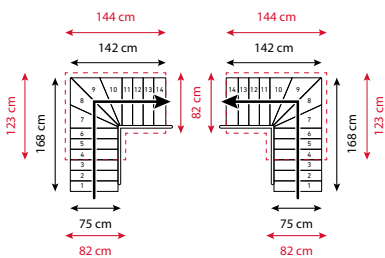
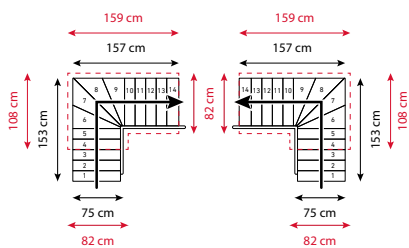
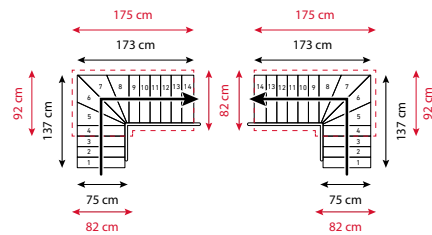
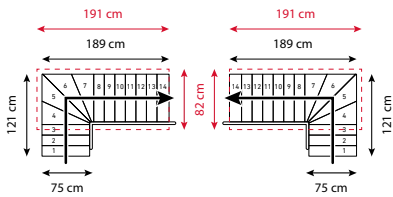
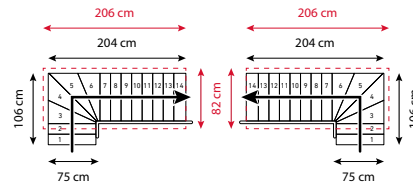
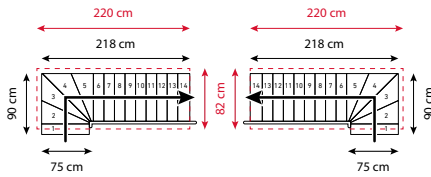
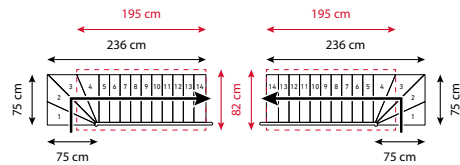
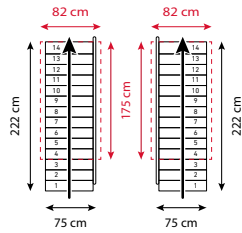



# DUBLIN 14 TREADS - WIDTH 71 CM

**H** 277.5 - 337.5 cm

— Staircase dimensions incl. handrail on 1 side

- - Floor opening size is defined based on 2 cm space to wall, 5 cm space for hand, 19 cm rise height, 25 cm deck thickness, 203 cm headspace.

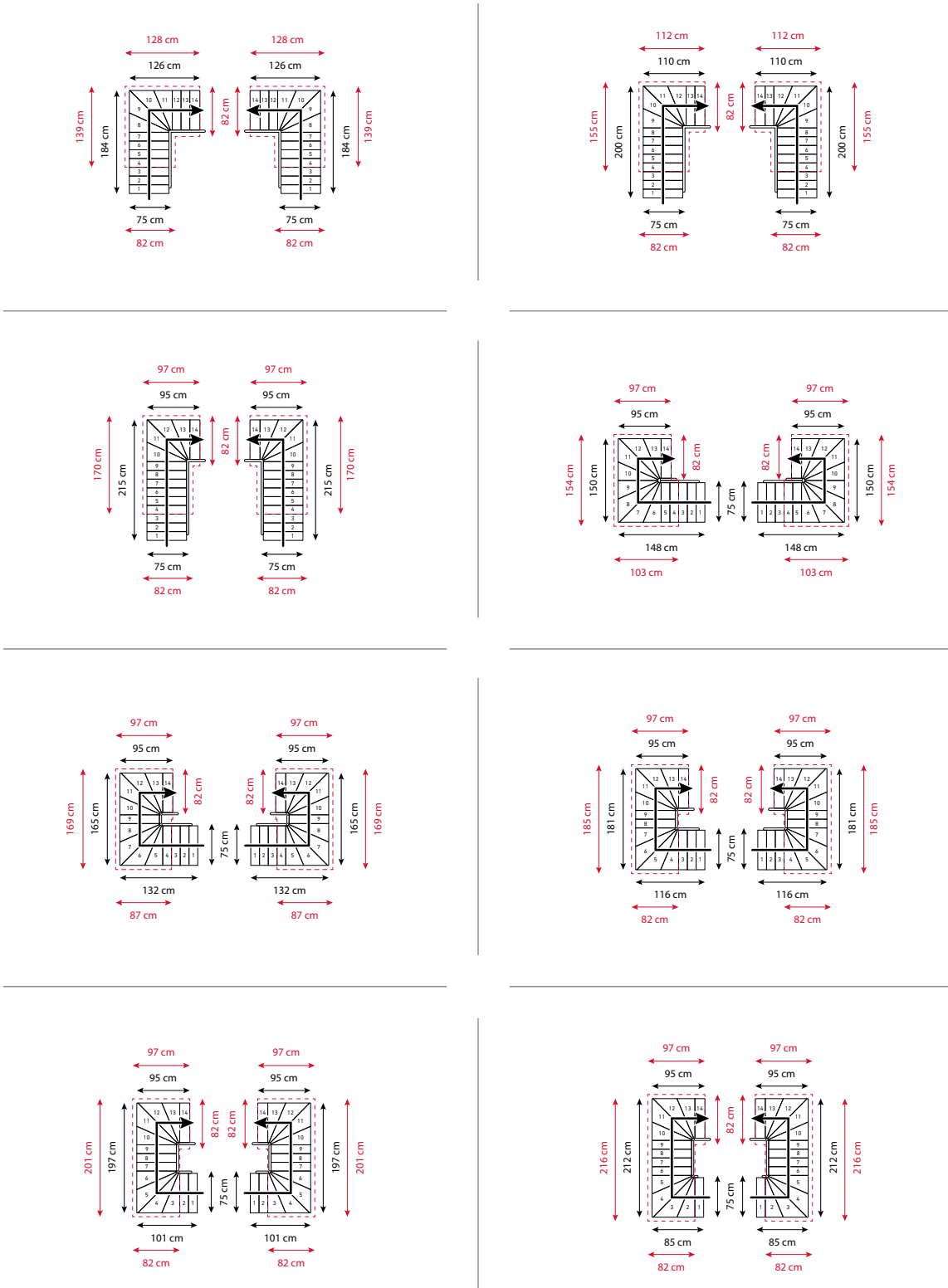

# DUBLIN 14 TREADS - WIDTH 71 CM

H 277.5 - 337.5 cm

— Staircase dimensions incl. handrail on 1 side

--- Floor opening size is defined based on 2 cm space to wall, 5 cm space for hand, 19 cm rise height, 25 cm deck thickness, 203 cm headspace.

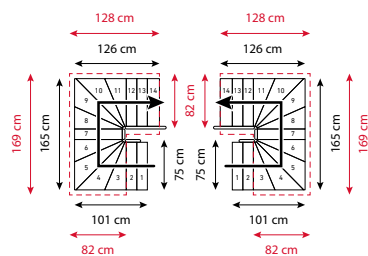
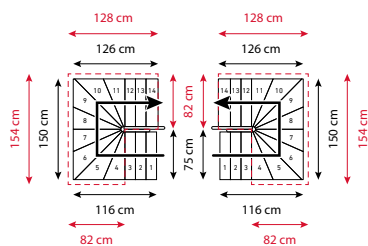
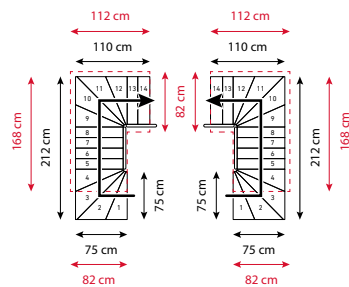
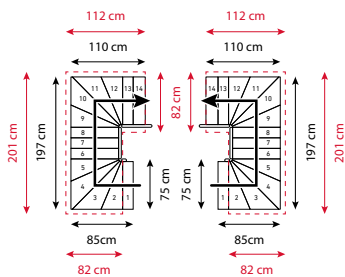
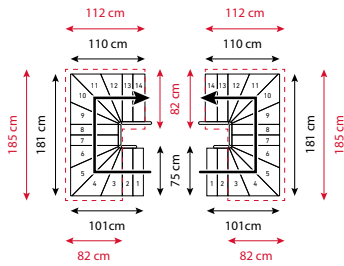
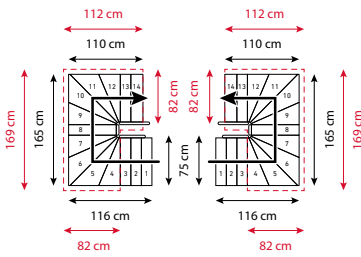
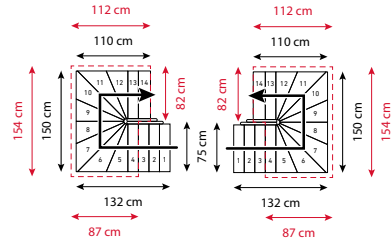
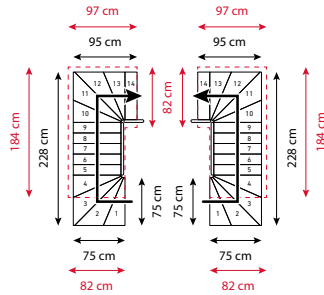

# DUBLIN 14 TREADS - WIDTH 71 CM

H 277.5 - 337.5 cm

— Staircase dimensions incl. handrail on 1 side

- - Floor opening size is defined based on 2 cm space to wall, 5 cm space for hand, 19 cm rise height, 25 cm deck thickness, 203 cm headspace.

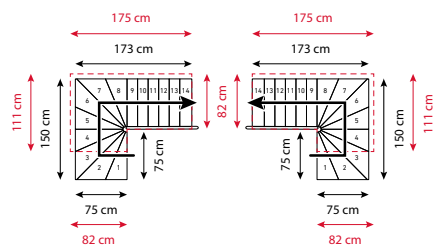
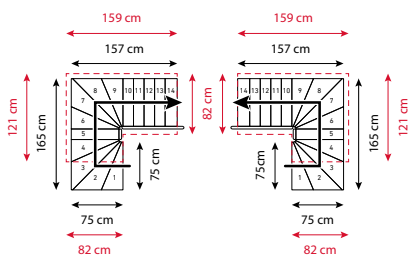
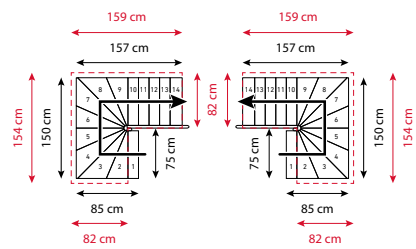
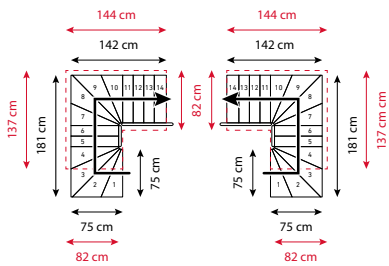
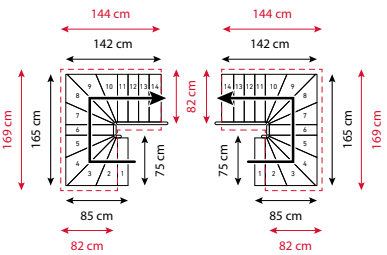
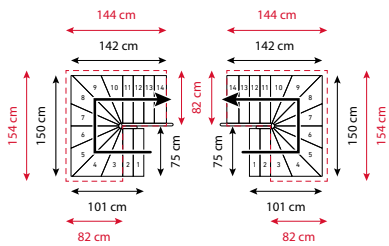
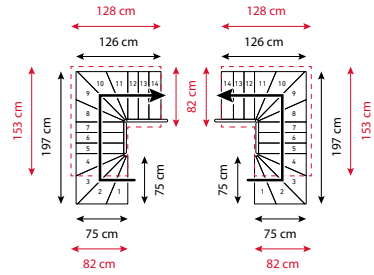
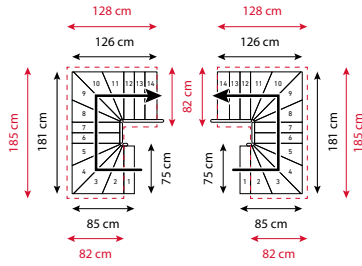

# DUBLIN 15 TREADS - WIDTH 71 CM

**H** 296 - 360 cm — Staircase dimensions incl. handrail on 1 side

--- Floor opening size is defined based on 2 cm space to wall, 5 cm space for hand, 19 cm rise height, 25 cm deck thickness, 203 cm headspace.

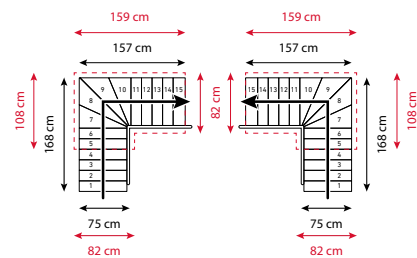
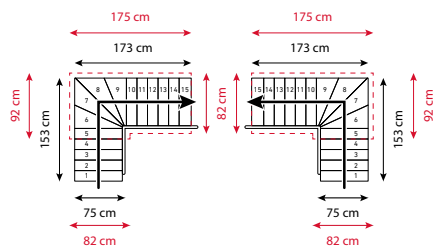
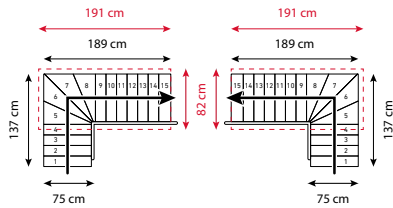
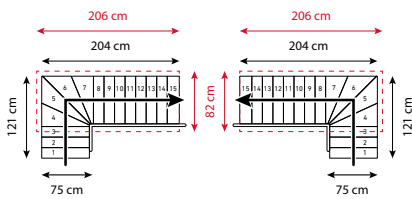
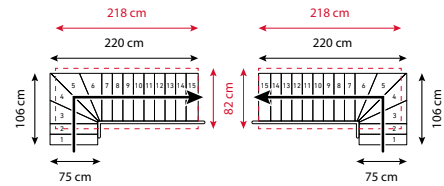
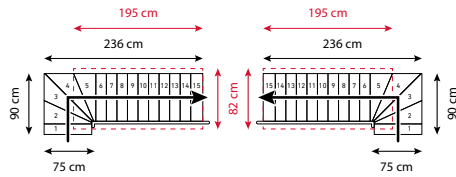
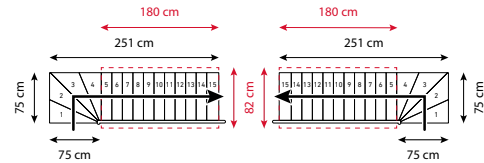
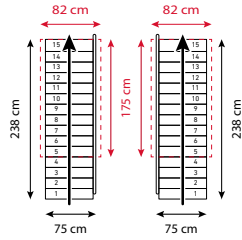

# DUBLIN 15 TREADS - WIDTH 71 CM

H 296 - 360 cm

— Staircase dimensions incl. handrail on 1 side

- - - Floor opening size is defined based on 2 cm space to wall, 5 cm space for hand, 19 cm rise height, 25 cm deck thickness, 203 cm headspace.

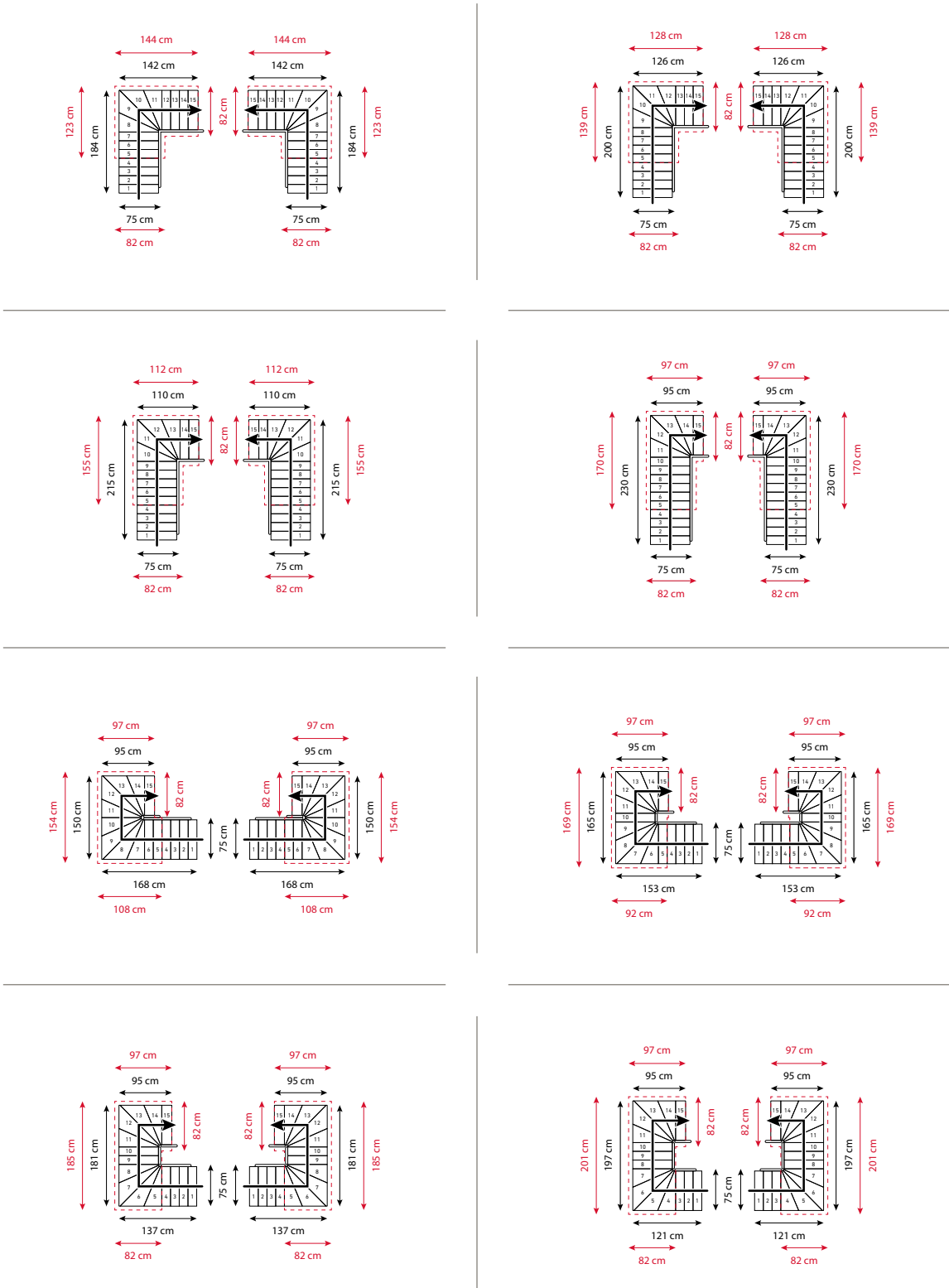

# DUBLIN 15 TREADS - WIDTH 71 CM

H 296 - 360 cm

— Staircase dimensions incl. handrail on 1 side

- - - Floor opening size is defined based on 2 cm space to wall, 5 cm space for hand, 19 cm rise height, 25 cm deck thickness, 203 cm headspace.

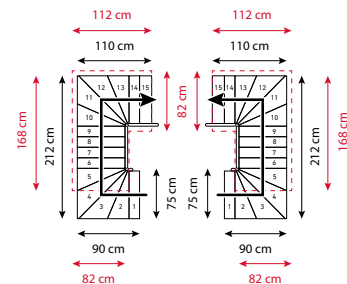
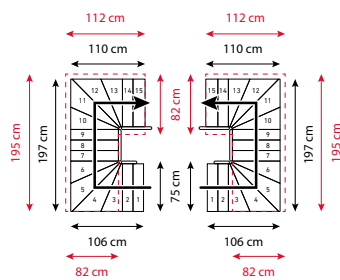
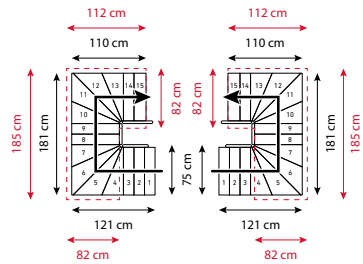
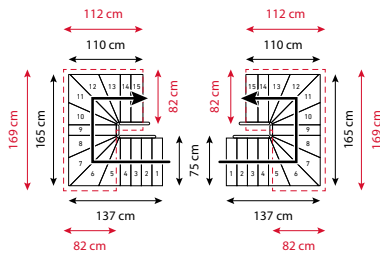
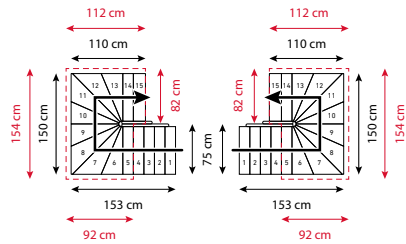
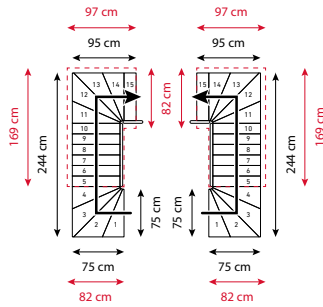
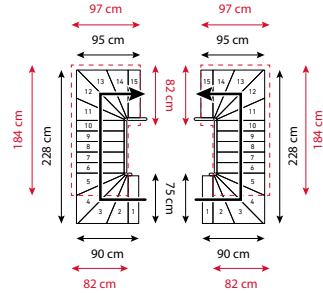
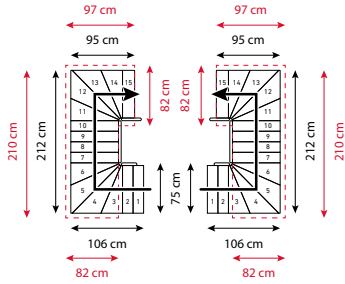

# DUBLIN 15 TREADS - WIDTH 71 CM

H 296 - 360 cm

— Staircase dimensions incl. handrail on 1 side

- - - Floor opening size is defined based on 2 cm space to wall, 5 cm space for hand, 19 cm rise height, 25 cm deck thickness, 203 cm headspace.

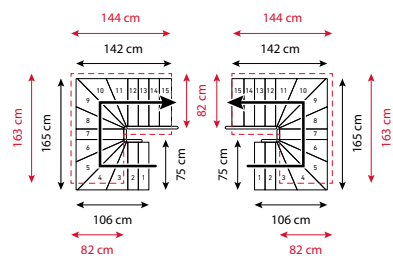
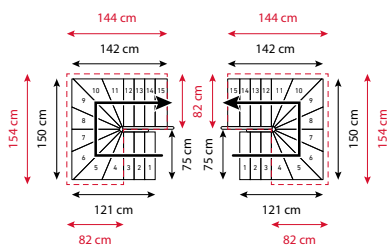
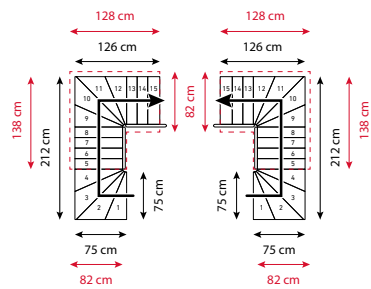
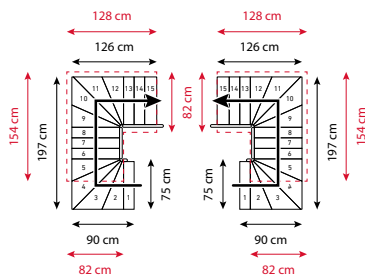
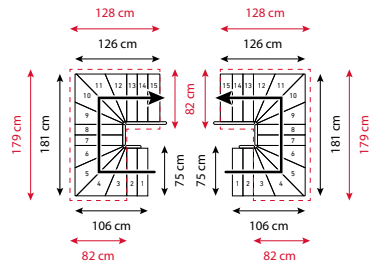
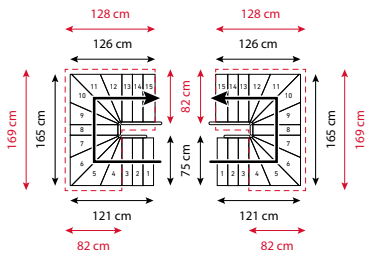
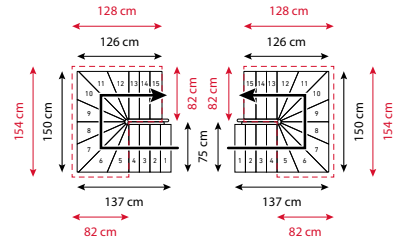
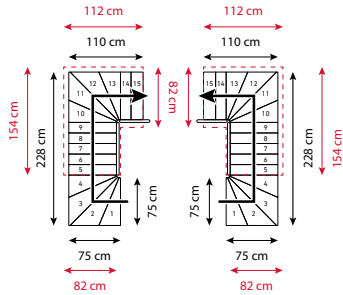

# DUBLIN 15 TREADS - WIDTH 71 CM

H 296 - 360 cm

— Staircase dimensions incl. handrail on 1 side

- - - Floor opening size is defined based on 2 cm space to wall, 5 cm space for hand, 19 cm rise height, 25 cm deck thickness, 203 cm headspace.

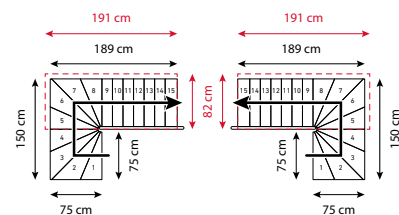
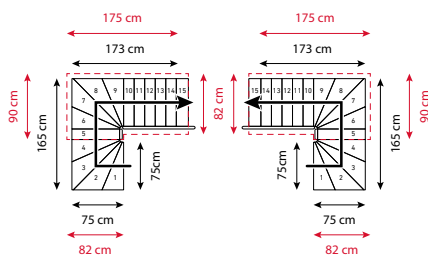
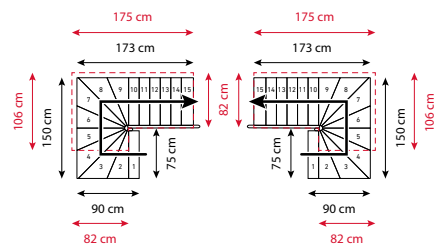
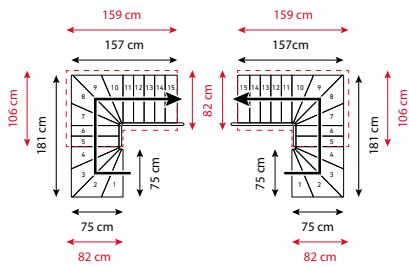
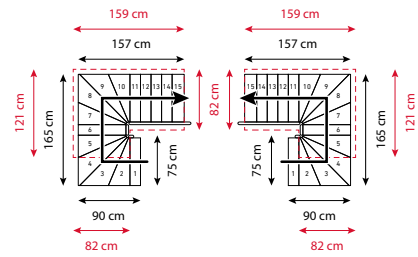
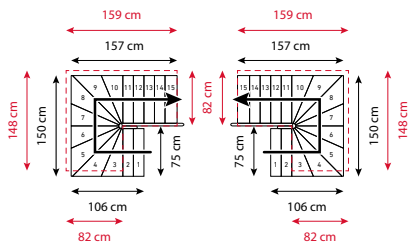
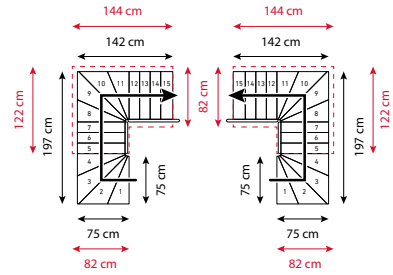
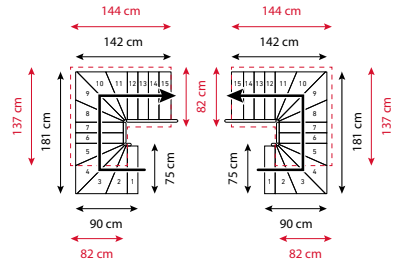



# DUBLIN QUATERTURN

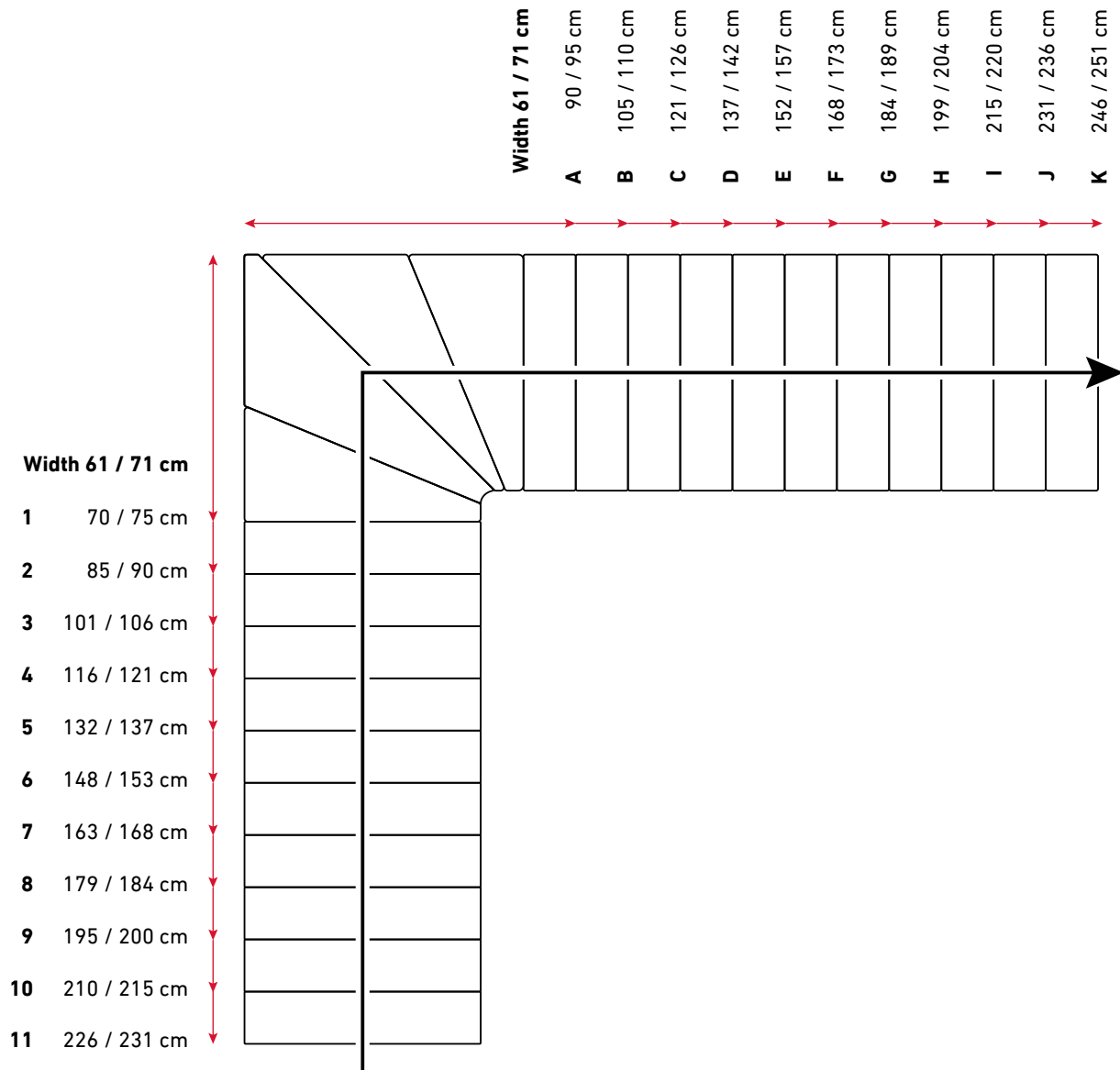

# DUBLIN HALFTURN

