

Loftstuga 30m²

Med fem fönster och veranda



SORSELESTUGAN
Ver. 1.5

Tel. +46 952 12222
E-Mail: info@sorselestugan.se www.sorselestugan.se

Skala 1:100 om ej annan anges. Utstick knutar: 150mm

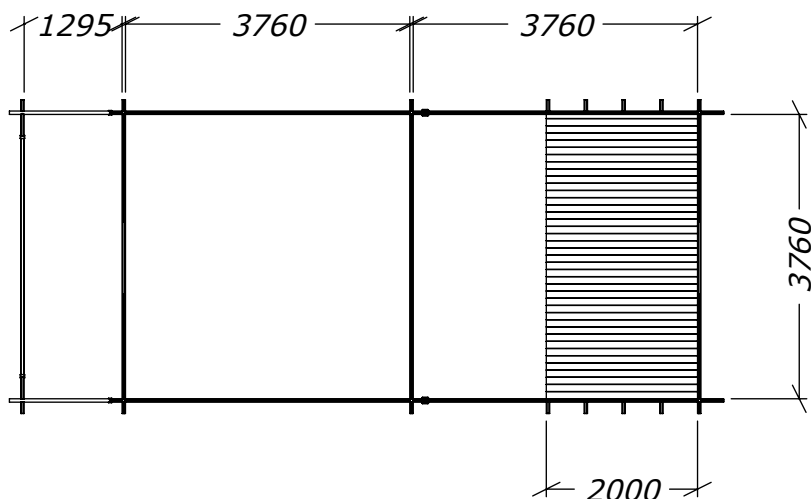
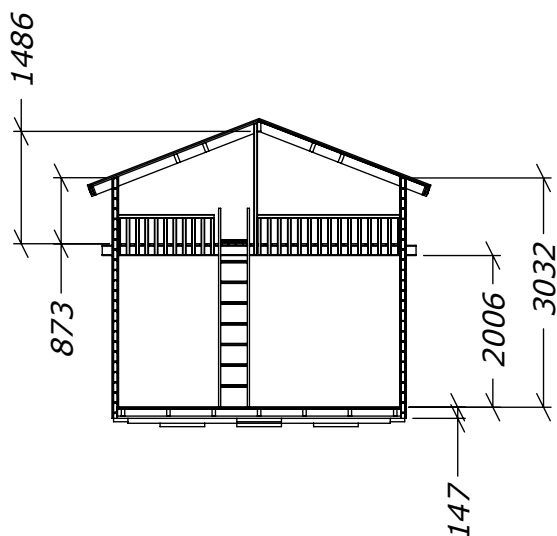
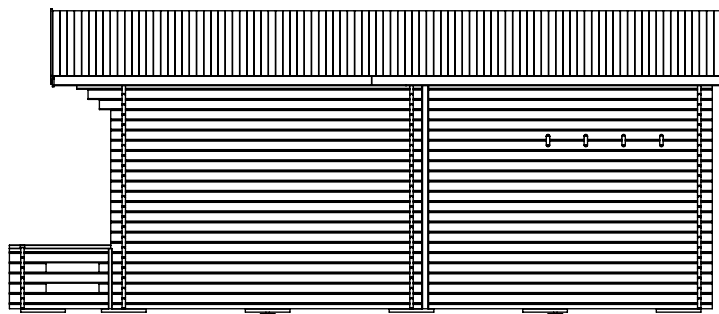
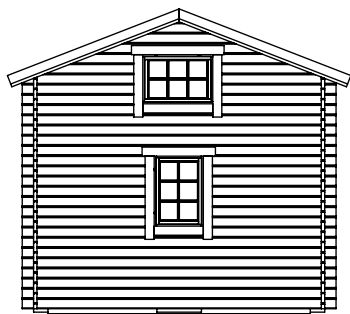
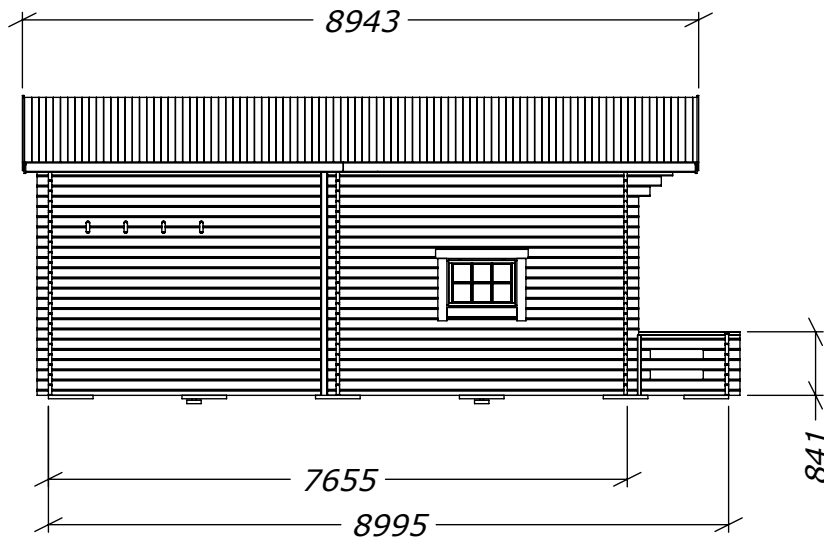
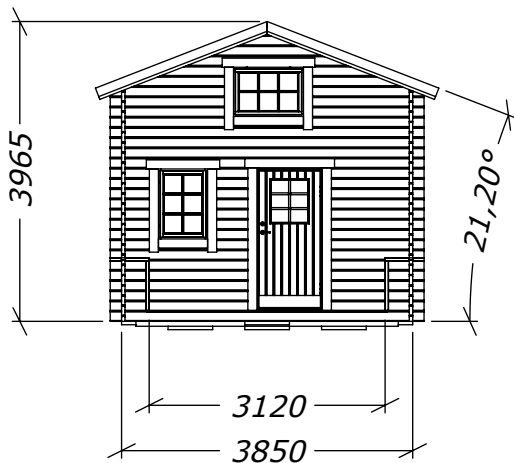

Hål för fönster bredvid dörr är klart vid leverans, resterande fyra hål tas upp av kund på valfri plats på stugan.

Öppning till inre rum tas upp av kund till valfri storlek*.

*30cm måste sparas vid ytterväggar.

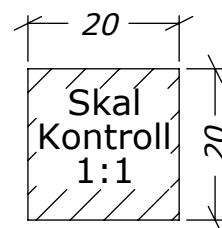

Loftstuga 30m²

Plintritning



SORSELESTUGAN
Ver. 1.5

Tel. +46 952 12222

E-Mail: info@sorselestugan.se www.sorselestugan.se

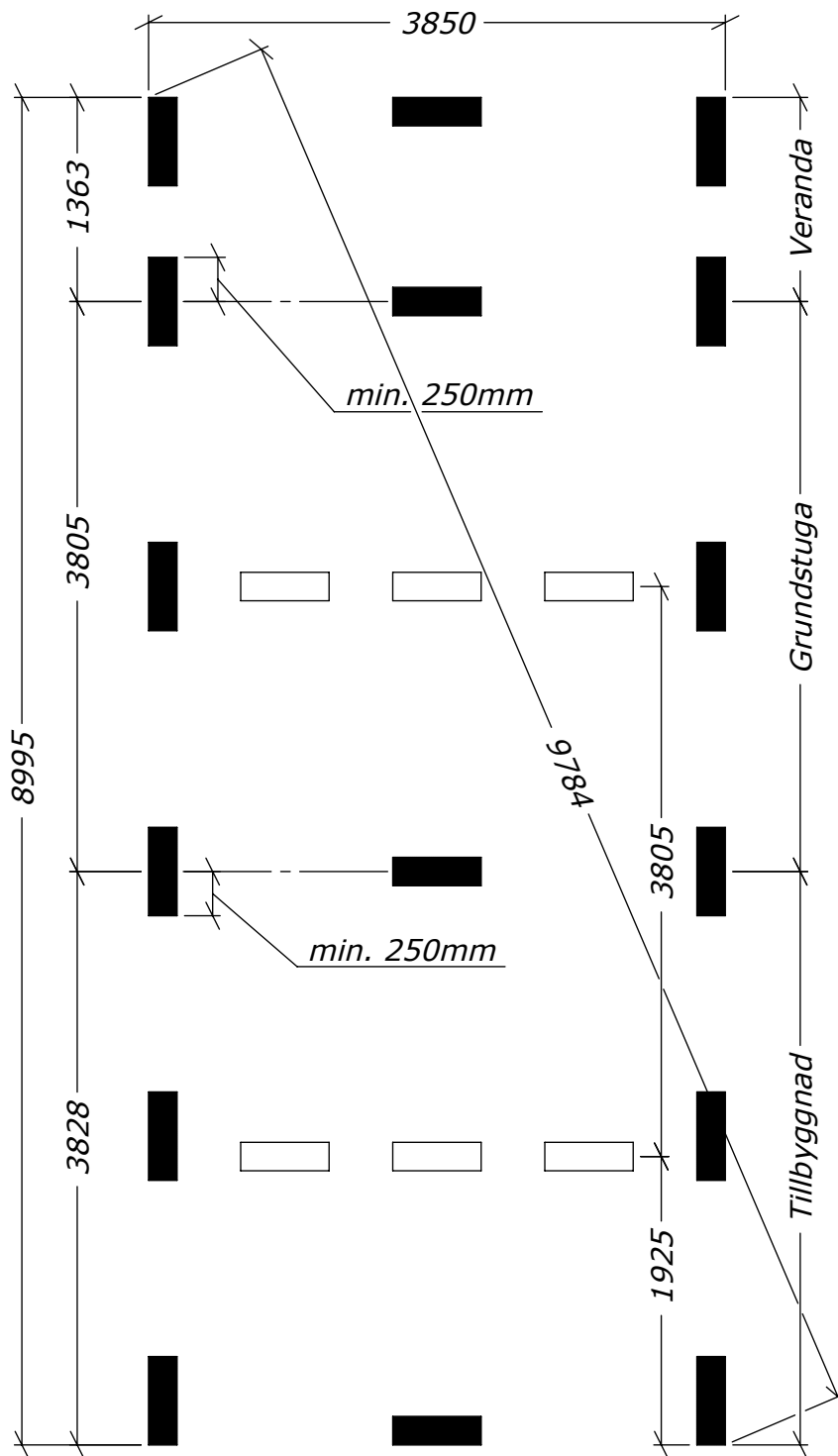

= OBS! 65mm lägre.

Loftstuga 30m²

Plintritning - runda

Tel. +46 952 12222
E-Mail: info@sorselestugan.se www.sorselestugan.se

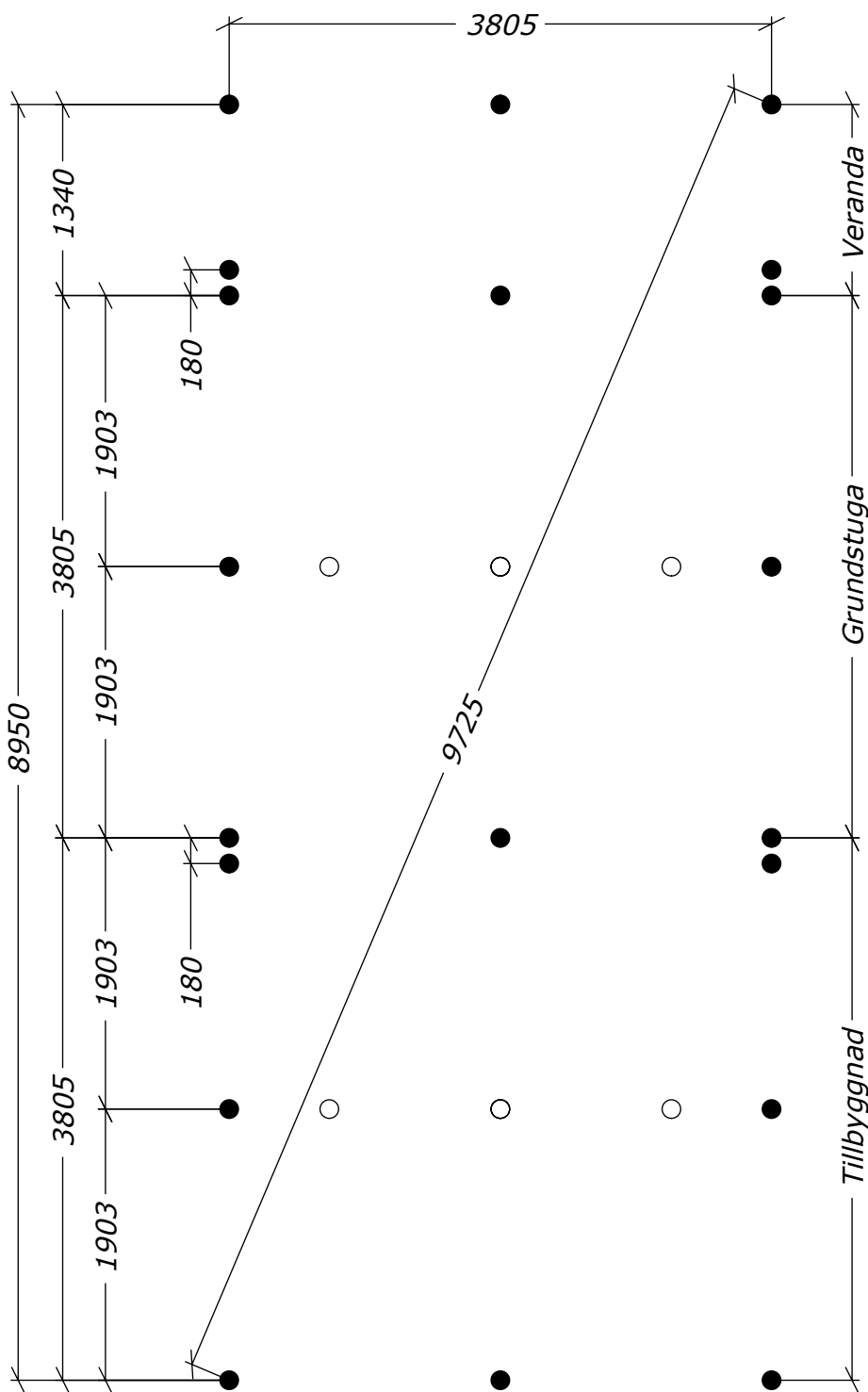

○ = OBS! 65mm lägre.